



<b>1</b>	<b>DISPLAYS</b>	<b>005</b>
<b>2</b>	<b>BLACKBOARDS &amp; SHOWCASES</b>	<b>081</b>
<b>3</b>	<b>EVENTS</b>	<b>107</b>
<b>4</b>	<b>STANCHIONS</b>	<b>185</b>
<b>5</b>	<b>TENTS &amp; INFLATABLES</b>	<b>199</b>
<b>6</b>	<b>INFO HOLDERS &amp; FRAMES</b>	<b>211</b>
<b>7</b>	<b>TEXTIL</b>	<b>291</b>
<b>8</b>	<b>SIGNAGE</b>	<b>347</b>
<b>9</b>	<b>CABLE KIT</b>	<b>401</b>
<b>10</b>	<b>PRODUCT EXHIBITION</b>	<b>415</b>
<b>11</b>	<b>CARDBOARD</b>	<b>447</b>
<b>12</b>	<b>P.O.S. SOLUTIONS</b>	<b>475</b>
<b>13</b>	<b>COATING</b>	<b>553</b>
<b>14</b>	<b>SHOPFITTING</b>	<b>571</b>



# DISPLAYS 01

Complete range of portable displays which provide an integral solution for the exhibition at promotional events, stores or business presentations.

- 6** X-BANNER
- 10** L-BANNER
- 12** ROLL UP | ECONOMIC
- 16** ROLL UP | STANDARD
- 20** ROLL UP | STYLISH
- 25** ROLL UP | DELUXE
- 31** ROLL UP | LARGE
- 35** ROLL UP ACCESSORIES
- 38** DESKTOP DISPLAYS
- 40** STAND DISPLAYS
- 49** REFILLABLE BASES
- 52** DISPLAY BASES
- 58** SIDEWALK BOARDS





# X-BANNER Display

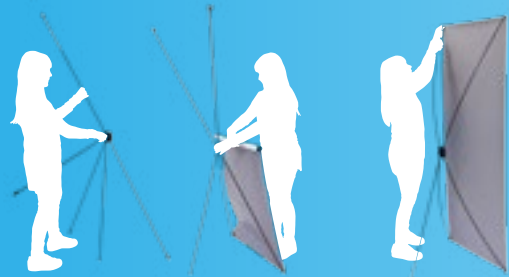

## DISPLAY DETAILS

## GRAPHIC BY EYELETS

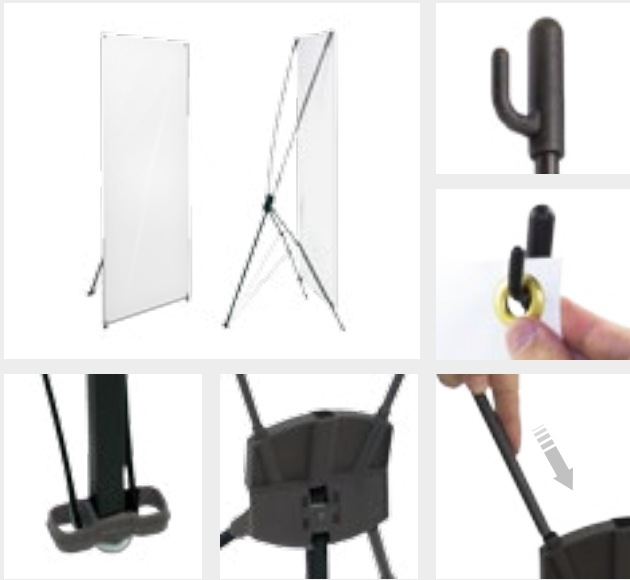

## DIMENSIONS

\*mm

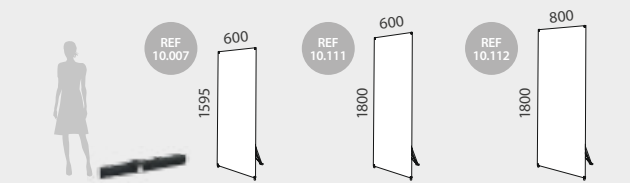

## INFORMATION

Tudela X-Banner is a portable, detachable and lightweight display for interchangeable graphics. Its X-shaped structure is made of fiberglass and plastic. The exhibitors can quickly assemble it in a few seconds (no tools required). Tudela features 3 sizes available and it includes a nylon carry bag.

600x1595	QTY	N.W	G.W	C.B.M	SIZE
Packing	10	9kg	10kg	0.0525	1010x200x260mm
Uni.	1	0.90kg	1kg	0.005	160x30x1080mm
<b>10.007</b>	<b>Graphic Size: 600x1595mm</b>				
600x1800	QTY	N.W	G.W	C.B.M	SIZE
Packing	10	9.5kg	10.5kg	0.0629	1210x200x260mm
Uni.	1	0.95kg	1.05kg	0.007	160x40x1210mm
<b>10.111</b>	<b>Graphic Size: 600x1800mm</b>				
800x1800	QTY	N.W	G.W	C.B.M	SIZE
Packing	10	10kg	11kg	0.0629	1210x200x260mm
Uni.	1	1kg	1.1kg	0.008	170x40x1210mm
<b>10.112</b>	<b>Graphic Size: 800x1800mm</b>				

## TUDELA



## DISPLAY DETAILS

## GRAPHIC BY EYELETS

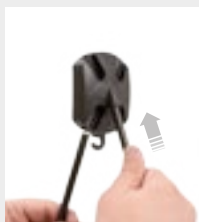

## DIMENSIONS

\*mm

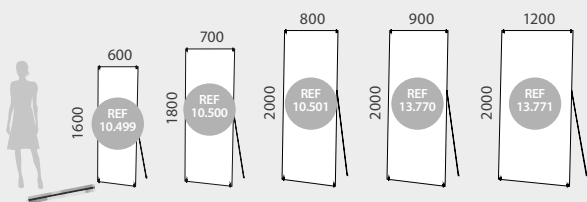

## INFORMATION

The Lyon X-Banner is a portable, detachable and very lightweight display for interchangeable graphics. Its X-shaped structure is made of fiberglass and plastic. Quickly assembly in seconds (no tools required). It includes a nylon carry bag. Lyon features 5 sizes available.

600x1600	QTY	N.W	G.W	C.B.M	SIZE
Packing	50	16.5kg	17.5kg	0.1298	350x350x1060mm
Uni.	1	0.30kg	0.35kg	0.009	140x60x1060mm
<b>10.499</b>	<b>Graphic Size: 600x1600mm</b>				

700x1800	QTY	N.W	G.W	C.B.M	SIZE
Packing	50	20kg	22kg	0.1484	400x350x1060mm
Uni.	1	0.35kg	0.40kg	0.009	140x60x1060mm
<b>10.500</b>	<b>Graphic Size: 700x1800mm</b>				

800x2000	QTY	N.W	G.W	C.B.M	SIZE
Packing	50	22.5kg	23.5kg	0.192	400x400x1200mm
Uni.	1	0.40kg	0.45kg	0.01	140x60x1200mm
<b>10.501</b>	<b>Graphic Size: 800x2000mm</b>				

900x2000	QTY	N.W	G.W	C.B.M	SIZE
Packing	20	14.6kg	15.7kg	0.178	1210x410x360mm
Uni.	1	0.73kg	1kg	0.01	140x60x1200mm
<b>13.770</b>	<b>Graphic Size: 900x2000mm</b>				

1200x2000	QTY	N.W	G.W	C.B.M	SIZE
Packing	20	22kg	23.2kg	0.193	1260x510x300mm
Uni.	1	1.1kg	1.3kg	0.01	140x60x1200mm
<b>13.771</b>	<b>Graphic Size: 1200x2000mm</b>				

## LYON



“ get extra tension using the hook with a counterweight ”

DISPLAY DETAILS



DISPLAY DETAILS

GRAPHIC ATTACHMENT BY EYELETS



DIMENSIONS

\*mm

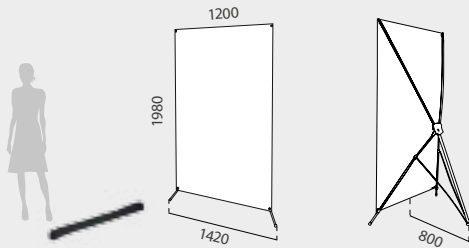

INFORMATION

Valoria X-Banner is a portable, detachable and lightweight display for interchangeable graphics. Its X-shaped structure is made of fiberglass and plastic parts. Exhibitors can quickly assemble it in a few seconds (no tools required). It includes a nylon carry bag. Because of its 1200mm width they are suitable for joining multiple units as a photocall or a promotional wall.

VALORIA	QTY	N.W	G.W	C.B.M	SIZE
Packing	10	16kg	17kg	0.1170	1400x380x220mm
Uni.	1	1.60kg	1.70kg	0.008	200x30x1360mm
10.006	Graphic Size: 1200x1980mm				

VALORIA

1.2m Width

COFFEE

77



DISPLAY DETAILS



DISPLAY DETAILS

GRAPHIC ATTACHMENT BY EYELETS



DIMENSIONS

\*mm

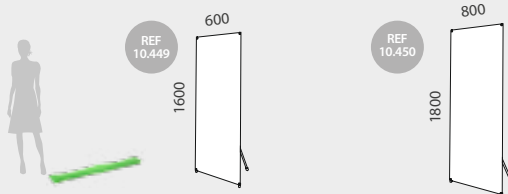

INFORMATION

The Bamboo X-Banner is a portable, detachable and lightweight display for interchangeable graphics. It is made of Bamboo Wood. Exhibitors can quickly assemble it in a few seconds (no tools required). A green nylon carry bag is included. Ideal for getting a touch of stylish and functional design.

BAMBOO 600	QTY	N.W	G.W	C.B.M	SIZE
Packing	40	20kg	22.50kg	0.13	450x270x1130mm
Uni.	1	0.50kg	0.55kg	0.004	105x40x980mm

10.449 Graphic Size: 600x1600mm

BAMBOO 800	QTY	N.W	G.W	C.B.M	SIZE
Packing	40	34kg	36kg	0.15	280x450x1180mm
Uni.	1	0.85kg	0.90kg	0.005	105x40x1100mm

10.450 Graphic Size: 800x1800mm

BAMBOO





# L-BANNER

## Display



### DISPLAY DETAILS



### INFORMATION

\*mm

Mestanza L-Banner is a detachable and lightweight display for interchangeable graphics. Its stable L-shaped structure is easy to set-up. Exhibitors can quickly assemble it with 3 simple steps. Includes a carry bag.

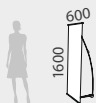

MESTANZA	QTY	N.W	G.W	C.B.M	SIZE
Packing	25	10kg	11.25kg	0.073	300x230x1060mm
Uni.	1	0.40kg	0.45kg	0.004	140x30x1060mm
10.774	Graphic Size: 600x1600mm				

## MESTANZA



### DISPLAY DETAILS

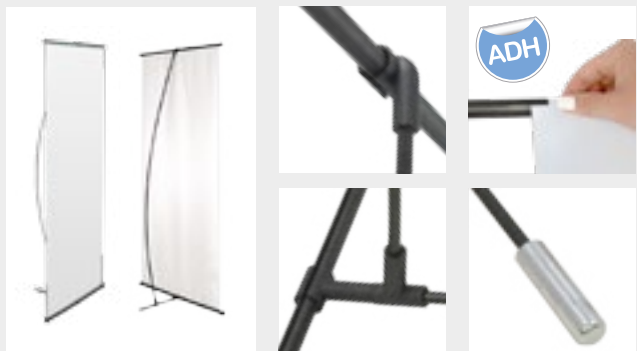

### INFORMATION

\*mm

Navas is a portable, detachable and lightweight display for interchangeable graphics. Its stable L-shape can quickly assemble in a few seconds (graphic is attached by adhesive) Includes a carry bag.



NAVAS	QTY	N.W	G.W	C.B.M	SIZE
Packing	20	14kg	20kg	0.081	340x240x1000mm
Uni.	1	0.70kg	1kg	0.012	110x110x930mm
10.001	Graphic Size: 600x1840mm				

## NAVAS





DISPLAY DETAILS



INFORMATION

\*mm

Bonne L-Banner is a detachable and lightweight display for interchangeable graphics. It is made of aluminium and plastic. Its stable L-shaped structure (with 490mm depth) is very easy to set-up, so exhibitors can quickly assemble in only a few seconds (the graphic is attached by upper snap rail). Also, Bonn L-Banner includes a black nylon carry bag for a better transportation.

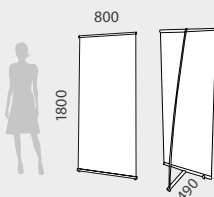

BONN



BONN	QTY	N.W	G.W	C.B.M	SIZE
Packing	10	11kg	12kg	0.0498	830x200x300mm
Uni.	1	1.10kg	1.20kg	0.023	200x125x950mm
10.575	Graphic Size: 800x1800mm				



# ROLL-UP Display



## DISPLAY DETAILS



## DIMENSIONS

\*mm

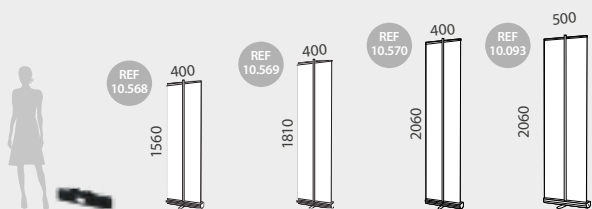

## INFORMATION

Abadia Roll Up is a portable and lightweight display for interchangeable and retractable graphics. It is made of aluminium and plastic parts. Banner rolls up and down in seconds making setting up presentation quick and easy. It includes a carry bag for effortless transport. Abadia is ideal to display in front of columns.

ABADIA 1	QTY	N.W	G.W	C.B.M	SIZE
Packing	10	7.5kg	8kg	0.04	450x210x470mm
Uni.	1	0.75kg	0.80kg	0.003	95x95x430mm
<b>10.568</b>	<b>Graphic Size: 400x1560mm</b>				
ABADIA 2	QTY	N.W	G.W	C.B.M	SIZE
Packing	10	7.5kg	8kg	0.04	450x210x470mm
Uni.	1	0.75kg	0.80kg	0.003	95x95x430mm
<b>10.569</b>	<b>Graphic Size: 400x1810mm</b>				
ABADIA 3	QTY	N.W	G.W	C.B.M	SIZE
Packing	10	7.5kg	8kg	0.04	450x210x470mm
Uni.	1	0.75kg	0.80kg	0.003	95x95x430mm
<b>10.570</b>	<b>Graphic Size: 400x2060mm</b>				
ABADIA 4	QTY	N.W	G.W	C.B.M	SIZE
Packing	10	15kg	17kg	0.06	485x230x600mm
Uni.	1	1.5kg	1.7kg	0.004	95x95x550mm
<b>10.093</b>	<b>Graphic Size: 500x2060mm</b>				

## ABADIA



“  
Ideal for being used in front of columns  
”

# ROLL UP BANNER Economic Roll Up

## DISPLAY DETAILS



## DIMENSIONS

\*mm

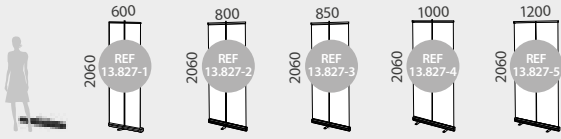

## INFORMATION

Torino features a kit of accessories (sold separately) which allow you to join together with another Torino and get a 2-sided view. Set up is easy, just line up the 2 Units, connect the bases, raise the banners and connect them at top. Carry bag included.

## TORINO



600x2060	QTY	N.W	G.W	C.B.M	SIZE
Packing	10	12.7kg	13.5kg	0.04	430x170x650mm
Uni.	1	1.27kg	1.35kg	0.005	90x90x625mm
<b>13.827-600</b>	<b>Graphic Size: 600x2060mm</b>				
800x2060	QTY	N.W	G.W	C.B.M	SIZE
Packing	10	17kg	18kg	0.06	430x170x850mm
Uni.	1	1.7kg	1.8kg	0.006	90x90x825mm
<b>13.827-800</b>	<b>Graphic Size: 800x2060mm</b>				
850x2060	QTY	N.W	G.W	C.B.M	SIZE
Packing	10	19kg	20kg	0.06	430x170x900mm
Uni.	1	1.9kg	2kg	0.007	90x90x875mm
<b>13.827-850</b>	<b>Graphic Size: 850x2060mm</b>				
1000x2060	QTY	N.W	G.W	C.B.M	SIZE
Packing	10	21kg	22kg	0.07	430x170x1050mm
Uni.	1	2.1kg	2.2kg	0.008	90x90x1025mm
<b>13.827-1000</b>	<b>Graphic Size: 1000x2060mm</b>				
1200x2060	QTY	N.W	G.W	C.B.M	SIZE
Packing	10	25kg	26kg	0.09	430x170x1250mm
Uni.	1	2.5kg	2.6kg	0.009	90x90x1225mm
<b>13.827-1200</b>	<b>Graphic Size: 1200x2060mm</b>				

## DOUBLE-SIDED ACCESSORIES KIT

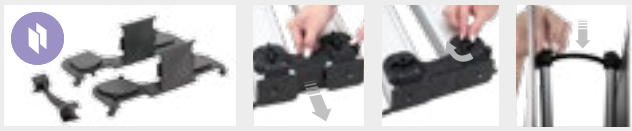

ACCESSORIES	QTY	N.W	G.W	C.B.M	SIZE
Packing	10	4.5kg	5kg	0.017	430x220x180mm
Uni.	1	0.45kg	0.47kg	0.0057	250x150x150mm
<b>13.828</b>	<b>Double Side Accessories Kit</b>				



“ get a presentation without feet, using 2 Torino units. ”

## DISPLAY DETAILS

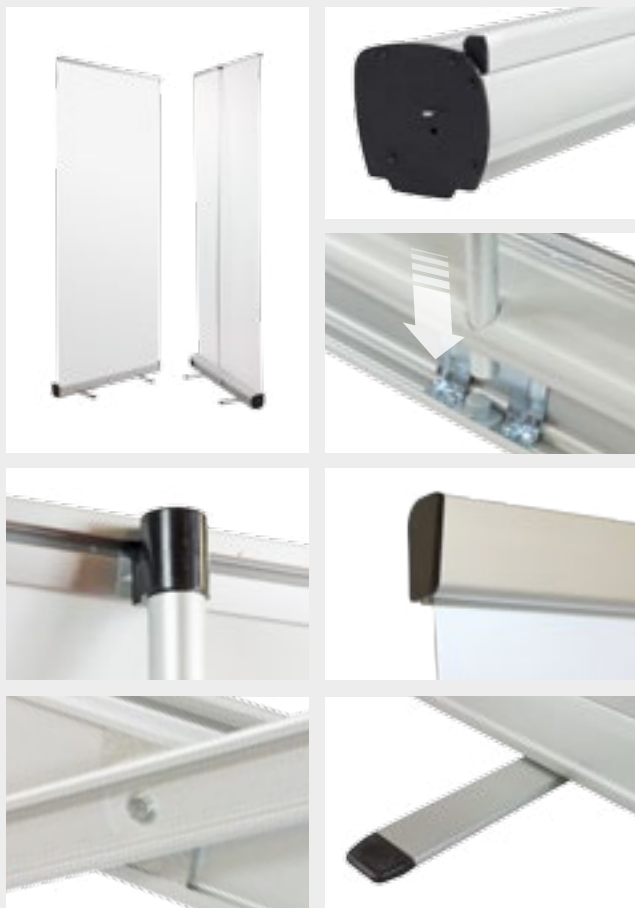

## DIMENSIONS

\*mm

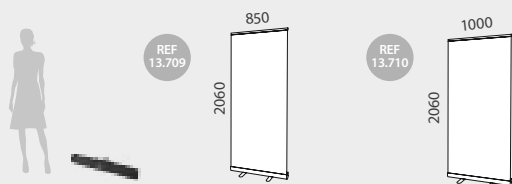

## INFORMATION

The Sidney Roll Up is a quick yet economical solution for your business presentation needs. It features metal connections at base feet and also, an improved stability thanks its special joining pole piece. It is made of anodized aluminium and plastic parts. Also it includes a hand strap carry bag.

SIDNEY 850	QTY	N.W	G.W	C.B.M	SIZE
Packing	6	10.8kg	12kg	0.051	300x200x850mm
Uni.	1	1.8kg	2kg	0.007	90x90x875mm
<b>13.709</b>	<b>Graphic Size: 850x2060mm</b>				

SIDNEY 1000	QTY	N.W	G.W	C.B.M	SIZE
Packing	6	13.8kg	15kg	0.063	300x200x1050mm
Uni.	1	2.3kg	2.5kg	0.008	90x90x1040mm
<b>13.710</b>	<b>Graphic Size: 1000x2060mm</b>				

## SIDNEY



“  
The Roll Up design saves floor space  
”

# ROLL UP BANNER Economic Roll Up

## DISPLAY DETAILS



## DIMENSIONS

\*mm

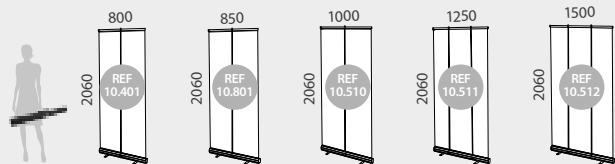

## INFORMATION

Alcala Roll Ups features 5 widths available. It is made of aluminium and plastic parts. Banner rolls up and down in seconds making setting up presentation quick and easy. Also it includes a single oxford carry bag.

800x2060	QTY	N.W	G.W	C.B.M	SIZE
Packing	6	11.5kg	12kg	0.05	300x210x850mm
Uni.	1	1.91kg	2kg	0.006	90x90x840mm
<b>10.401</b>	<b>Graphic Size: 800x2060mm</b>				
850x2060	QTY	N.W	G.W	C.B.M	SIZE
Packing	6	12.5kg	13kg	0.06	300x210x900mm
Uni.	1	2.08kg	2.16kg	0.007	90x90x875mm
<b>10.801</b>	<b>Graphic Size: 850x2060mm</b>				
1000x2060	QTY	N.W	G.W	C.B.M	SIZE
Packing	6	14.5kg	15kg	0.07	300x210x1050mm
Uni.	1	2.41kg	2.5kg	0.008	90x90x1040mm
<b>10.510</b>	<b>Graphic Size: 1000x2060mm</b>				
1250x2060	QTY	N.W	G.W	C.B.M	SIZE
Packing	6	18.5kg	19kg	0.08	300x210x1300mm
Uni.	1	3.03kg	3.16kg	0.012	95x95x1270mm
<b>10.511</b>	<b>Graphic Size: 1250x2060mm</b>				
1500x2060	QTY	N.W	G.W	C.B.M	SIZE
Packing	6	20.5kg	21kg	0.10	300x210x1550mm
Uni.	1	3.41kg	3.50kg	0.013	100x95x1520mm
<b>10.512</b>	<b>Graphic Size: 1500x2060mm</b>				

## ALCALA



“ Use optional spotlight for highlight your exhibitions (sold separately) ”

DISPLAY DETAILS



DIMENSIONS

\*mm

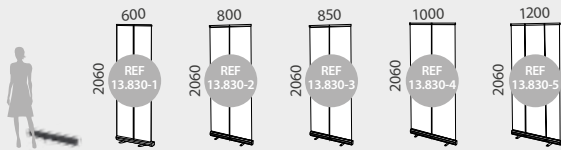

600x2060	QTY	N.W	G.W	C.B.M	SIZE
Packing	6	16.2kg	16.65kg	0.05	350x240x670mm
Uni.	1	2.70kg	2.77kg	0.009	110x110x650mm
<b>13.830-600</b>	<b>Graphic Size: 600x2060mm</b>				
800x2060	QTY	N.W	G.W	C.B.M	SIZE
Packing	6	19.9kg	20kg	0.07	350x240x670mm
Uni.	1	3.2kg	3.33kg	0.012	110x110x850mm
<b>13.830-800</b>	<b>Graphic Size: 800x2060mm</b>				
850x2060	QTY	N.W	G.W	C.B.M	SIZE
Packing	6	20.4kg	21kg	0.07	350x240x920mm
Uni.	1	3.4kg	3.5kg	0.012	110x110x900mm
<b>13.830-850</b>	<b>Graphic Size: 850x2060mm</b>				
1000x2060	QTY	N.W	G.W	C.B.M	SIZE
Packing	6	21.3kg	22.2kg	0.08	350x240x1070mm
Uni.	1	3.55kg	3.7kg	0.014	110x110x1050mm
<b>13.830-1000</b>	<b>Graphic Size: 1000x2060mm</b>				
1200x2060	QTY	N.W	G.W	C.B.M	SIZE
Packing	6	27.6kg	29.45kg	0.10	350x240x1270mm
Uni.	1	4.6kg	4.9kg	0.017	110x110x1250mm
<b>13.830-1200</b>	<b>Graphic Size: 1200x2060mm</b>				

ORLEANS



# ROLL UP BANNER Standard Roll Up

**new**

## DISPLAY DETAILS



## INFORMATION

Orleans is one of the best-selling Roll-Ups in the world. Featuring an extra weight aluminium structure with 10 sizes available. Banner rolls up and down in seconds making setting up presentation quick and easy. It includes a carry bag.

## DIMENSIONS

\*mm

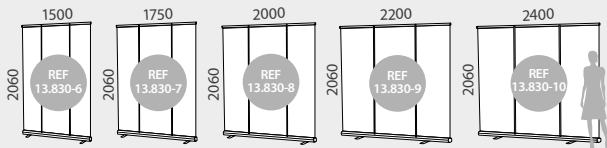

1500x2060	QTY	N.W	G.W	C.B.M	SIZE
Packing	4	22kg	23.4kg	0.09	250x250x1580mm
Uni.	1	5.5kg	5.85kg	0.024	120x120x1560mm
<b>13.830-1500</b>	<b>Graphic Size: 1500x2060mm</b>				
1750x2060	QTY	N.W	G.W	C.B.M	SIZE
Packing	2	11.8kg	12.3kg	0.05	130x250x1830mm
Uni.	1	5.9kg	6.15kg	0.029	120x120x1810mm
<b>13.830-1750</b>	<b>Graphic Size: 1750x2060mm</b>				
2000x2060	QTY	N.W	G.W	C.B.M	SIZE
Packing	2	13kg	14kg	0.06	130x250x2070mm
Uni.	1	6.5kg	7kg	0.033	120x120x2050mm
<b>13.830-2000</b>	<b>Graphic Size: 2000x2060mm</b>				
2200x2060	QTY	N.W	G.W	C.B.M	SIZE
Packing	2	14.6kg	15.4kg	0.07	130x250x2270mm
Uni.	1	7.3kg	7.7kg	0.036	120x120x2250mm
<b>13.830-2200</b>	<b>Graphic Size: 2200x2060mm</b>				
2400x2060	QTY	N.W	G.W	C.B.M	SIZE
Uni.	1	8.2kg	8.5kg	0.08	130x130x2470mm
<b>13.830-2400</b>	<b>Graphic Size: 2400x2060mm</b>				

## ORLEANS



Use promotional counters for completing your exhibitions (sold separately)

## DISPLAY DETAILS



## DIMENSIONS

\*mm

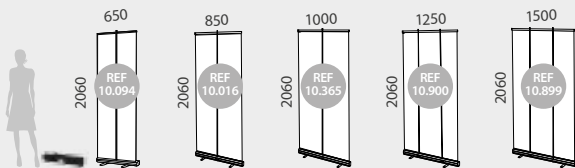

## INFORMATION

The Alberca Roll Up features an extra weight aluminium structure with 5 widths available. Banner rolls up and down in seconds making setting up presentation quick and easy. Also it includes a double padded carry bag.

650x2060	QTY	N.W	G.W	C.B.M	SIZE
Packing	10	16kg	18kg	0.06	700x200x480mm
Uni.	1	1.6kg	1.8kg	0.005	95x95x650mm

**10.094** Graphic Size: 650x2060mm

850x2060	QTY	N.W	G.W	C.B.M	SIZE
Packing	6	17.5kg	18kg	0.07	320x230x900mm
Uni.	1	2.91kg	3kg	0.009	100x100x890mm

**10.016** Graphic Size: 850x2060mm

1000x2060	QTY	N.W	G.W	C.B.M	SIZE
Packing	6	19.5kg	20kg	0.08	320x230x1050mm
Uni.	1	3.5kg	3.33kg	0.011	100x100x1040mm

**10.365** Graphic Size: 1000x2060mm

1250x2060	QTY	N.W	G.W	C.B.M	SIZE
Packing	6	21.5kg	22kg	0.10	320x230x1300mm
Uni.	1	3.58kg	3.66kg	0.012	100x100x1300mm

**10.900** Graphic Size: 1250x2060mm

1500x2060	QTY	N.W	G.W	C.B.M	SIZE
Packing	6	23kg	24kg	0.11	320x230x1550mm
Uni.	1	3.83kg	4kg	0.015	100x100x1540mm

**10.899** Graphic Size: 1500x2060mm

## ALBERCA

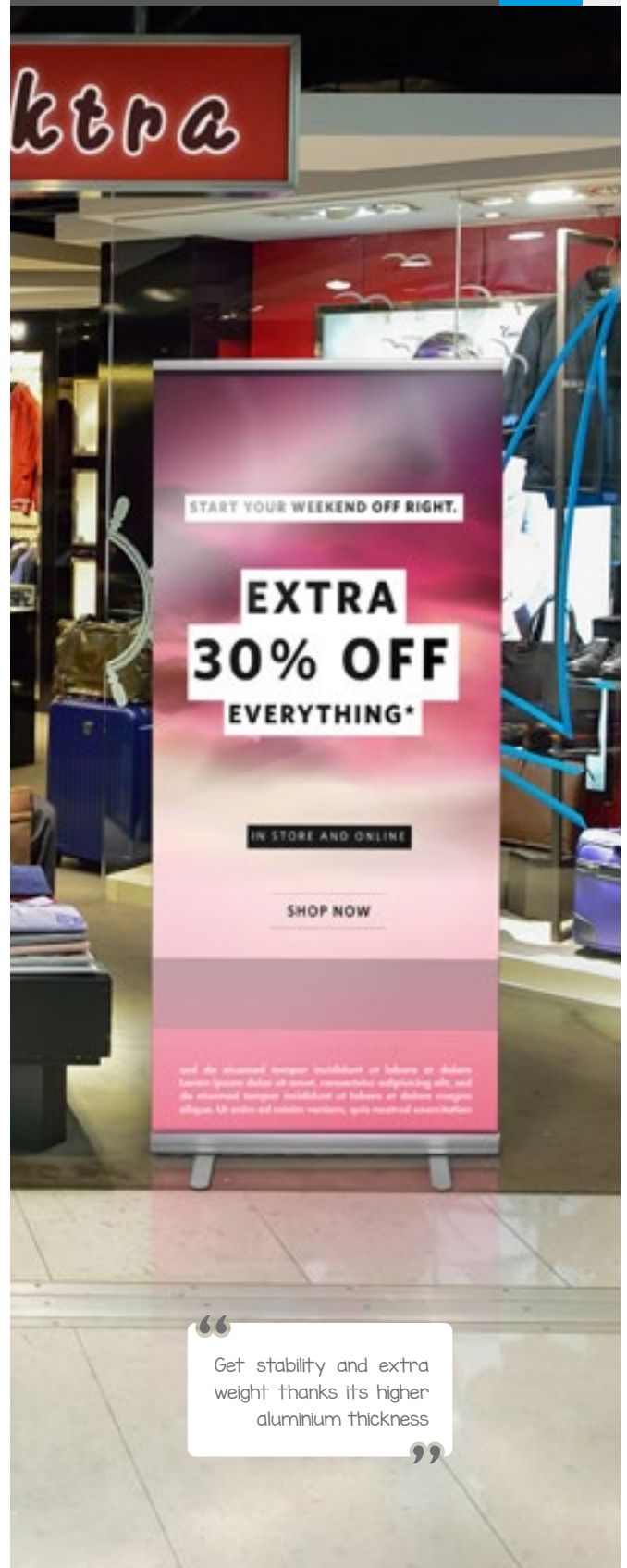

“ Get stability and extra weight thanks its higher aluminium thickness ”



# ROLL UP BANNER Standard Roll Up

## DISPLAY DETAILS

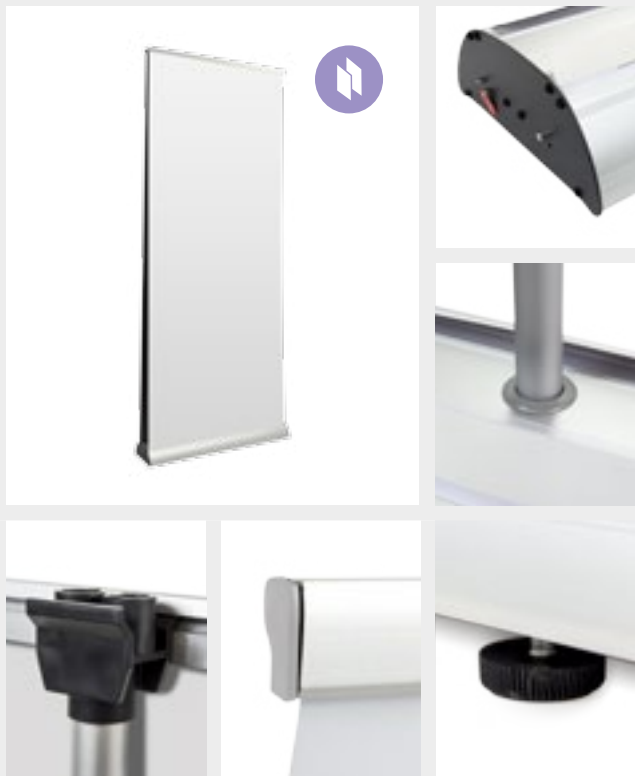

## DIMENSIONS

\*mm

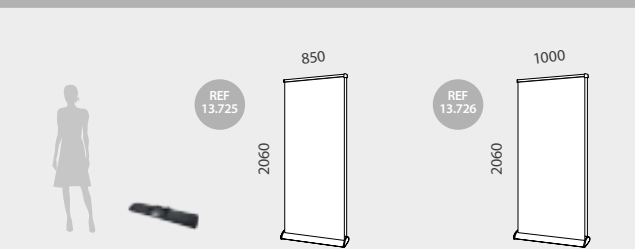

## INFORMATION

Mora is a Double Sided Roll Up wich features 2 widths available (850mm or 1000mm). It is made of aluminium and plastic parts. Banner rolls up and down in seconds making setting up presentation quick and easy. Mora features a stable base with no-feet design with leveling feet. Also it includes a carry bag. Ideal for trade shows, exhibitions, retail stores or any media event.

MORA 850	QTY	N.W	G.W	C.B.M	SIZE
Packing	4	15.6kg	18.8kg	0.02727	890x190x430mm
Uni.	1	3.90kg	4.70kg	0.021	900x130x180mm
13.725	Graphic Size: 850x2060mm				

MORA 1000	QTY	N.W	G.W	C.B.M	SIZE
Packing	4	17.6kg	21kg	0.0850	1040x190x430mm
Uni.	1	4.40kg	5.25kg	0.024	1040x130x180mm
13.726	Graphic Size: 1000x2060mm				

## MORA



## DISPLAY DETAILS



## DIMENSIONS

\*mm

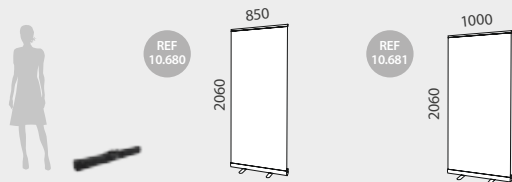

## INFORMATION

This Roll Up features a full black finish and it is made of durably aluminum so it is incredibly lightweight and saves floor space. Easy change of graphic, set up is quick and easy, just connect the pole to the base, roll up the graphic and hook it at the top of the pole. With canvas carry bag included. Ideal for trade shows, expositions, retail stores or any media event.

ALTEA 850	QTY	N.W	G.W	C.B.M	SIZE
Packing	10	22kg	24kg	0.093	490x210x910mm
Uni.	1	2.20kg	2.40kg	0.007	90x90x875mm
<b>10.680</b>	<b>Graphic Size: 850x2060mm</b>				

ALTEA 1000	QTY	N.W	G.W	C.B.M	SIZE
Packing	10	25kg	26kg	0.109	490x210x1060mm
Uni.	1	2.50kg	2.60kg	0.011	105x105x1040mm
<b>10.681</b>	<b>Graphic Size: 1000x2060mm</b>				

## ALTEA



“ Use optional spotlight for highlight your exhibitions (sold separately) ”

\* optional spotlight ( sold apart, see later Roll Up accessories at Cap. 1)

DISPLAY DETAILS



DIMENSIONS

\*mm

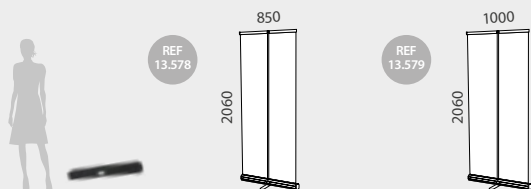

INFORMATION

This Roll Up banner is made of durably aluminum with plastic parts so it is incredibly lightweight and slim-line design that makes it visually appealing and saves floor space. Easy change of graphic, set up is quick and easy, users can simply connect the pole to the base, roll-up the graphic and hook the banner at the top of the pole. Additionally, a canvas carry bag is included. Ideal for trade shows, expositions, retail stores or any media event.

DUERO 850	QTY	N.W	G.W	C.B.M	SIZE
Packing	6	14.4kg	14.8kg	0.0786	320x270x910mm
Uni.	1	2.4kg	2.8kg	0.01	110x105x890mm
<b>13.578</b>	<b>Graphic Size: 850x2060mm</b>				

DUERO 1000	QTY	N.W	G.W	C.B.M	SIZE
Packing	6	16.8kg	17.4kg	0.0926	320x270x1060mm
Uni.	1	2.8kg	3.3kg	0.011	105x105x1040mm
<b>13.579</b>	<b>Graphic Size: 1000x2060mm</b>				

DUERO



DISPLAY DETAILS



DIMENSIONS

\*mm

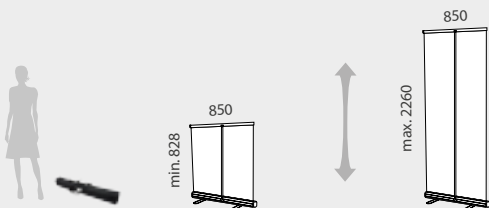

INFORMATION

This Roll Up banner is made of durably aluminum with plastic parts so it is incredibly lightweight and saves floor space. Featuring stylish open bases and adjustable height thanks to its telescopic pole. With an easy change of graphic, set up is quick and easy. Additionally, a canvas carry bag is included. Ideal for trade shows, expositions, retail stores or any media event.

DEHESA	QTY	N.W	G.W	C.B.M	SIZE
Packing	6	19.20kg	23kg	0.09	360x260x910mm
Uni.	1	3.15kg	3.50kg	0.01	110x110x900mm
10.020	Graphic Size: 850x828-2260mm				

DEHESA



“ Use promotional counters for completing your exhibitions (sold separately) ”

DISPLAY DETAILS



GRAPHIC CASSETTE EXCHANGE

DIMENSIONS

\*mm

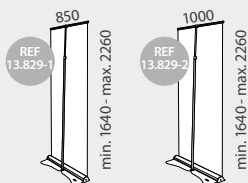
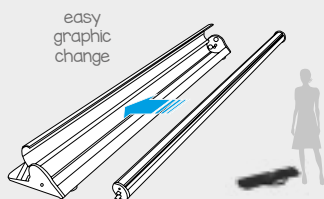

INFORMATION

Milano Roll Up is made of durably aluminum with plastic parts. It features an easy change of graphic thanks its unique design with a interchangeable cassette, graphic change is quick and easy, users can simply put the cassette into the base, roll-up the graphic and hook the banner at the top of the pole. Additionally, a canvas carry bag is included. Ideal for trade shows, expositions, retail stores or any media event.

MILANO 850	QTY	N.W	G.W	C.B.M	SIZE
Packing	4	16kg	17kg	0.07	300x260x920mm
Uni.	1	4kg	4.25kg	0.01	150x130x875mm
13.829-850	Graphic Size: 850x1640-2260mm				
MILANO 1000	QTY	N.W	G.W	C.B.M	SIZE
Packing	4	18kg	19kg	0.08	300x260x1000mm
Uni.	1	4.5kg	4.75kg	0.02	150x130x1025mm
13.829-1000	Graphic Size: 1000x1640-2260mm				

MILANO



“With an comfortable and fast change of graphic thanks its interchangeable cassette.”

DISPLAY DETAILS



DISPLAY DETAILS

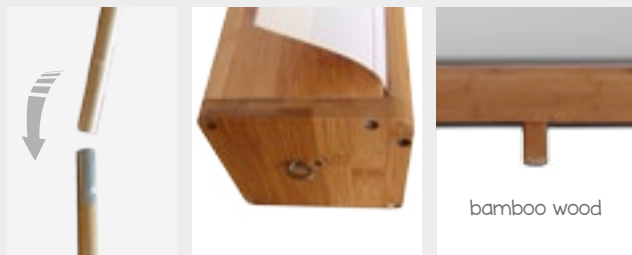

INFORMATION

\*mm

This Roll Up is made of bamboo wood. Featuring stylish natural design. With an easy change of graphic, set up is quick and easy. A nylon carry bag is included. Ideal for trade shows, expositions, retail stores or any event.

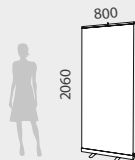

BAMBOO	QTY	N.W	G.W	C.B.M	SIZE
Packing	4	12.6kg	15.2kg	0.091	350x290x900mm
Uni.	1	3.15kg	3.80kg	0.02	170x140x870mm
10.444	Graphic Size: 800x2060mm				

BAMBOO



DISPLAY DETAILS



INFORMATION

DIMENSIONS

\*mm

Cervera Luxury Roll Up features silver or black finish available. The aluminum design is durable, yet attractive and adds a stylish and luxurious touch. Cervera base has leveling feet and also, it includes a double padded carry bag.

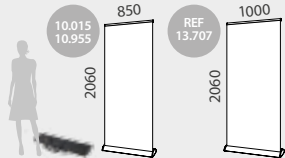

CERVERA 850	QTY	N.W	G.W	C.B.M	SIZE
Packing	4	17.4kg	20.6kg	0.083	890x190x430mm
Uni.	1	4.35kg	5.15kg	0.018	150x135x920mm
<b>10.015</b>	<b>Graphic Size: 850x2060mm</b>				

CERVERA 1000	QTY	N.W	G.W	C.B.M	SIZE
Packing	4	21.6kg	23.2kg	0.097	450x200x1080mm
Uni.	1	5.4kg	5.8kg	0.0216	150x135x1070mm
<b>13.707</b>	<b>Graphic Size: 1000x2060mm</b>				

CERVERA 850	QTY	N.W	G.W	C.B.M	SIZE
Packing	4	17.6kg	21kg	0.083	890x190x430mm
Uni.	1	4.4kg	5.25kg	0.018	150x135x920mm
<b>10.955</b>	<b>Graphic Size: 850x2060mm</b>				

CERVERA



“ Ideal for providing a distinguishing and stylish touch. ”

DISPLAY DETAILS



INFORMATION

\*mm

Ribas Roll Up features silver finish available. Its unique design is durable, yet attractive and adds a stylish and luxurious touch. Its base has leveling feet and also it is double-sided so it can be used as a sidewalk stand (ideal for areas with 2-ways traffic). It includes a double padded carry bag.

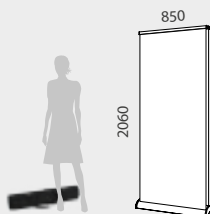

RIBAS



RIBAS	QTY	N.W	G.W	C.B.M	SIZE
Packing	4	22kg	26.6kg	0.16	530x300x980mm
Uni.	1	5.5kg	6.65kg	0.03	250x135x920mm
10.013	Graphic Size: 850x2060mm				



DISPLAY DETAILS

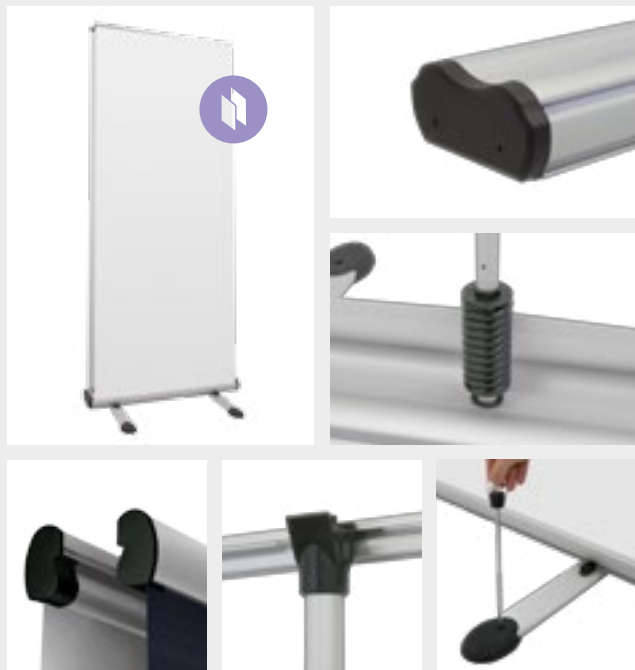

FLEX SYSTEM

\*mm

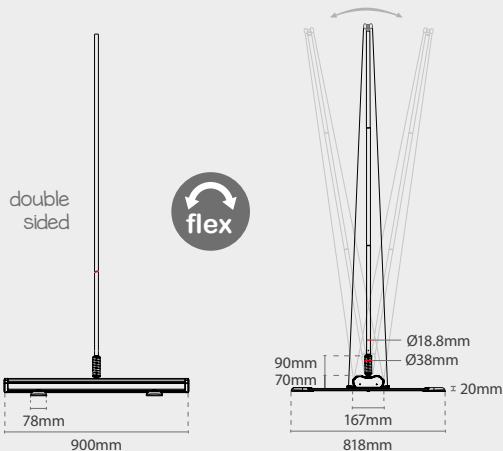

INFORMATION

\*mm

This Roll Up features a silver aluminium finish. Ibiza is suitable for being used at outdoor or indoor and its design features a flex system for resisting windy conditions. Its base is holed for being used with 4 stakes (included). Also, it is 2-sided so it can be used as a sidewalk stand (ideal for areas with 2-ways traffic). It includes a double padded carry bag.



IBIZA



IBIZA	QTY	N.W	G.W	C.B.M	SIZE
Packing	1	7.6kg	8.8kg	0.03	300x110x930mm
10.447		Graphic Size: 850x2060mm			

DISPLAY DETAILS

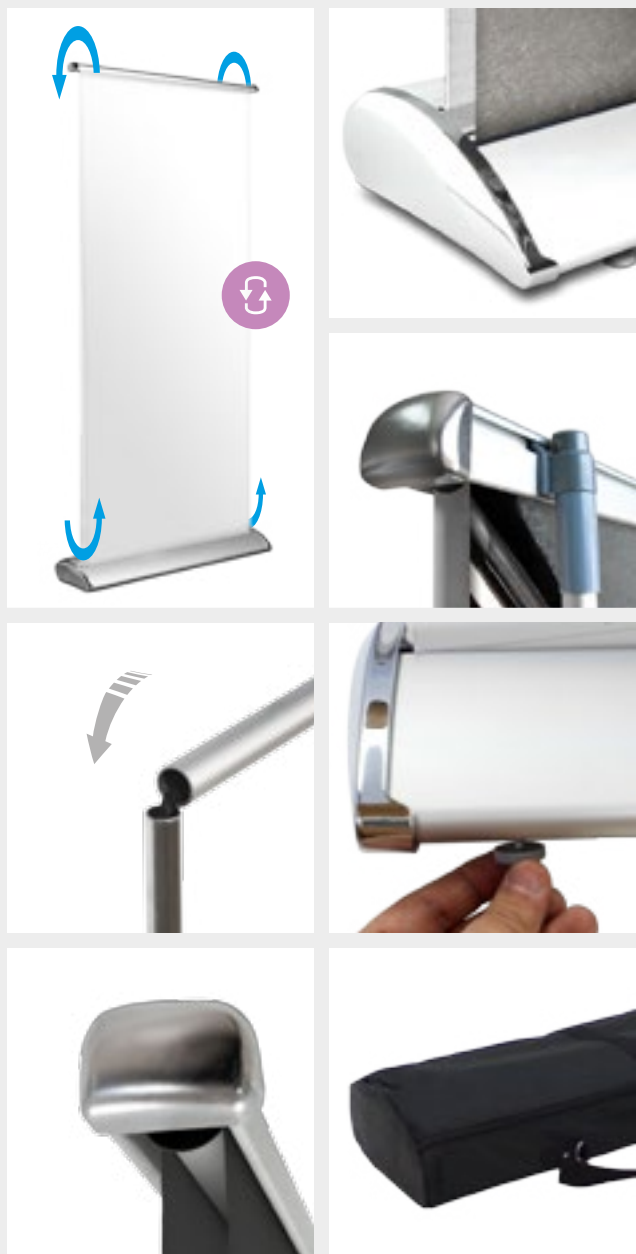

INFORMATION

\*mm

Pineda Roll Up features an electrical scrolling design which allows to display a large 4105mm and continuous graphic banner. Its base has leveling feet and it includes a double padded carry bag. Pineda Scroll Roll Up is ideal for being used at conventions, tradeshows, expositions, business presentations or at any media event.

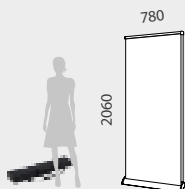

PINEDA	QTY	N.W	G.W	C.B.M	SIZE
Packing	4	19.80kg	24.60kg	0.16	530x300x980mm
Uni.	1	4.95kg	6.15kg	0.034	280x130x925mm
10.022	Graphic: 780x4105mm		Visible: 780x2060mm		

PINEDA SCROLL



DISPLAY DETAILS

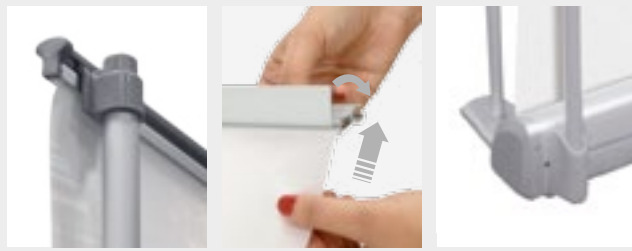

INFORMATION

\*mm

The Bremen Roll Up has a silver aluminium finish and it features a middle shelf for the displaying of promotional items or appetizers at tradeshow or conventions. Also, it has 2x A4 format trays for brochures or literature. It includes a double padded nylon carry bag.

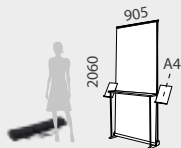

BREMEN



BREMEN	QTY	N.W	G.W	C.B.M	SIZE
Packing	1	6.30kg	6.95kg	0.037	250x150x990mm
10.826	Graphic Size: 905x2060mm				

## DISPLAY DETAILS

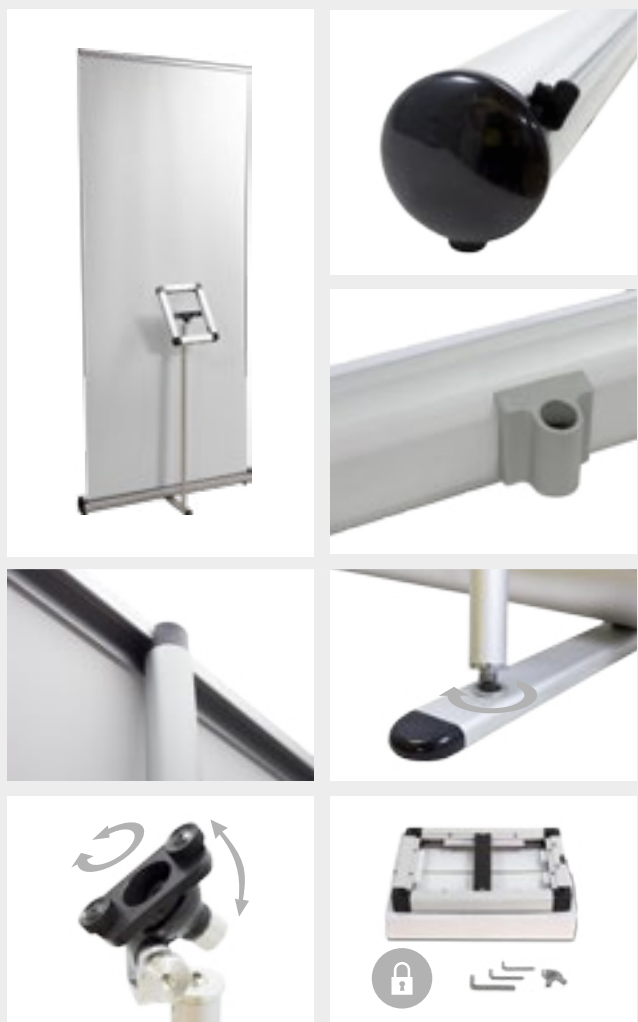

## INFORMATION

\*mm

This Roll Up features a tablet holder (2 sizes available) whose frame allows a 360° rotation. Also, it has lock for safety use. It includes a double padded carry bag. Pineda Scroll Roll Up is ideal for conventions, tradeshows, expositions, media events or any business presentation.

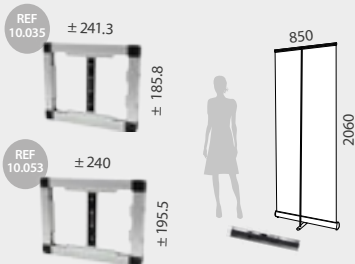

TABLET HOLDER 1	QTY	N.W	G.W	C.B.M	SIZE
Packing	1	0.75kg	0.90kg	0.003	260x47x310mm
		3.60kg	4.10kg	0.013	130x110x930mm

10.035 Roll Up Graphic Size: 850x2060mm  
Size for Tablets: ±185.8x241.3mm

TABLET HOLDER 2	QTY	N.W	G.W	C.B.M	SIZE
Packing	1	0.75kg	0.90kg	0.003	260x47x310mm
		3.60kg	4.10kg	0.013	130x110x930mm

10.053 Roll Up Graphic Size: 850x2060mm  
Size for Tablets: ±195.5x240mm

## TABLET HOLDER ROLL UP



“ See more Tablet Holders in Info & Frames (Chapter 6) ”

\* tablet is not included

# ROLL UP BANNER LARGE RESIST TELESCOPIC NO DRILL NO WELD Large Roll Up

## DISPLAY DETAILS



## DIMENSIONS

\*mm

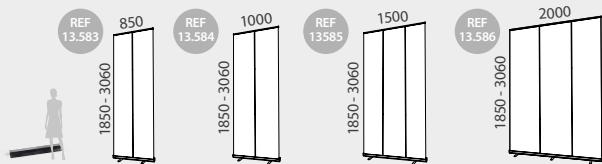

## INFORMATION

The Nepal Roll Up banner is made of durably aluminum with plastic parts and features an adjustable height up to 3m. Set up is quick and easy and users can adjust the height tilting lowering the Roll Up Banner. A Nylon Carry bag is included. Ideal for trade shows, convention centers, malls, expositions, retail stores or any media event where their large graphics can be seen from at the distance. There are 4 widths available.

NEPAL 850	QTY	N.W	G.W	C.B.M	SIZE
Packing	6	24kg	25kg	0.098	380x280x920mm
Uni.	1	4kg	4.2kg	0.0145	125x130x895mm
<b>13.583</b>	<b>Graphic Size: 850x1850-3060mm</b>				
NEPAL 1000	QTY	N.W	G.W	C.B.M	SIZE
Packing	6	28.2kg	29kg	0.1138	380x280x1070mm
Uni.	1	4.7kg	4.83kg	0.017	125x130x1050mm
<b>13.584</b>	<b>Graphic Size: 1000x1850-3060mm</b>				
NEPAL 1500	QTY	N.W	G.W	C.B.M	SIZE
Packing	2	13.8kg	15kg	0.064	270x150x1580mm
Uni.	1	6.9kg	7.5kg	0.025	125x130x1565mm
<b>13.585</b>	<b>Graphic Size: 1500x1850-3060mm</b>				
NEPAL 2000	QTY	N.W	G.W	C.B.M	SIZE
Uni.	1	9.5kg	11kg	0.0468	150x150x2080mm
<b>13.586</b>	<b>Graphic Size: 2000x1850-3060mm</b>				

## NEPAL



# ROLL UP BANNER LARGE RESIST ✕ 📦 🔄 Large Roll Up

## DISPLAY DETAILS

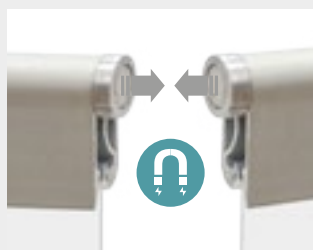

## INFORMATION

## DIMENSIONS

\*mm

The Everest Roll Up banner is made of durable aluminum with magnetic side connection parts, featuring 3m height. At the top of each banner stand, there are patented magnetic connectors that allow you to join together multiple units with a simple "click". Because of its size, it is a great alternative to pop up displays and trade show booths. Set up is quick and easy, and users can adjust the height tilting lowering the Roll Up Banner. Additionally, a canvas carry bag is included. This Roll Up makes a great graphic mural in trade show booths, in press conferences, convention centers, in malls, expositions, retail stores or any other media event.

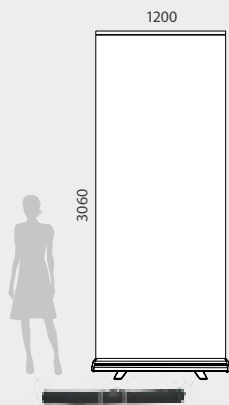

EVEREST	QTY	N.W	G.W	C.B.M	SIZE
Packing	6	40.2kg	45kg	0.15	420x290x1260mm
Uni.	1	6.50kg	7.30kg	0.018	120x120x1260mm
10.861	Graphic Size: 1200x3060mm				

## EVEREST

3m High



“ join it with other Everest Roll Up for creating a photocal presentation ”

# ROLL UP BANNER LARGE RESIST Large Roll Up

## DISPLAY DETAILS

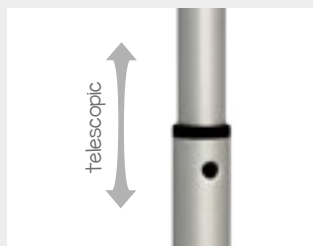

## DIMENSIONS

\*mm

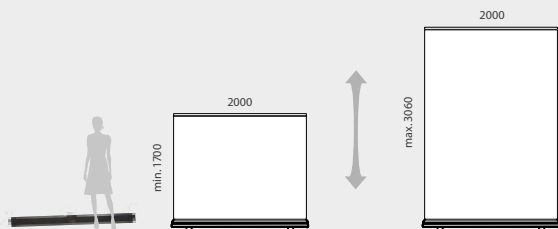

## INFORMATION

If you are looking for something bigger, the Mont Blanc Roll Up Banner is 2000mm wide, featuring an adjustable height up to 3060mm. It is the perfect alternate to a trade show booth or pop up display. Due to its large height, assembly is easiest when you set up along the floor and then stand the display up. Also thanks to its telescopic capacity, the roll up Mont Blanc can be used in any other smaller places, with a minimum height of 1700mm. It comes with a carrying bag. It is perfect for trade shows, convention centers, for press conferences, expositions or for media events.

MONT BLANC	QTY	N.W	G.W	C.B.M	SIZE
Packing	1	13kg	14.80kg	0.061	180x160x2120mm
10.441	Graphic Size: 2000x1700-3060mm				

## MONT BLANC

XL



# ROLL UP BANNER



Large Roll Up

## DISPLAY DETAILS

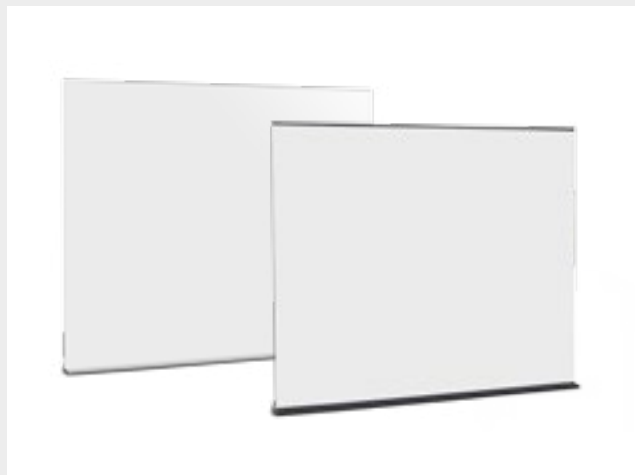

## INFORMATION

## DIMENSIONS

\*mm

Max Elda is the widest Roll Up, made of sturdy aluminium features 2 different widths, 2400 and 3200mm. Silver and black finish is available. Additionally, it includes a canvas carry nylon bag.

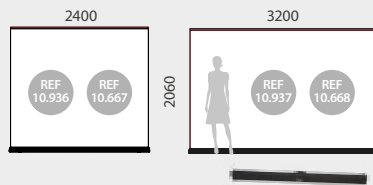

2400 SILVER	QTY	N.W	G.W	C.B.M	SIZE	
Packing	2	21.2kg	26.6kg	0.189	320x230x2580mm	
Uni.	1	10.6kg	13.3kg	0.071	320x90x2480mm	
<b>10.936</b>	<b>Graphic Size: 2400x2060mm</b>					
3200 SILVER	QTY	N.W	G.W	C.B.M	SIZE	
Packing	2	22kg	30.1kg	0.253	320x230x440mm	
Uni.	1	11kg	15.05kg	0.096	320x90x3340mm	
<b>10.937</b>	<b>Graphic Size: 3200-2060mm</b>					
2400 BLACK	QTY	N.W	G.W	C.B.M	SIZE	
Packing	2	21.2kg	26.6kg	0.189	320x230x2580mm	
Uni.	1	10.6kg	13.3kg	0.071	320x90x2480mm	
<b>10.667</b>	<b>Graphic Size: 2400x2060mm</b>					
3200 BLACK	QTY	N.W	G.W	C.B.M	SIZE	
Packing	2	22kg	30.1kg	0.253	320x230x440mm	
Uni.	1	11kg	15.05kg	0.096	320x90x3340mm	
<b>10.668</b>	<b>Graphic Size: 3200x2060mm</b>					

## MAX ELDA



\* optional counter ( sold apart, see later in Events chapter )



## BAG DETAILS



## INFORMATION

\*mm

- One side zipped. With Id Pocket.
- Shoulder and hand strap.



850 | 1000 | 1250 | 1500

SINGLE 850	QTY	N.W	G.W	C.B.M	SIZE
------------	-----	-----	-----	-------	------

Packing	1	0.12kg	0.22kg	0.0035	120x30x980mm
---------	---	--------	--------	--------	--------------

**13.461** For Roll Up 850mm

SINGLE 1000	QTY	N.W	G.W	C.B.M	SIZE
-------------	-----	-----	-----	-------	------

Packing	1	0.15kg	0.25kg	0.0037	120x30x1030mm
---------	---	--------	--------	--------	---------------

**13.462** For Roll Up 1000mm

SINGLE 1250	QTY	N.W	G.W	C.B.M	SIZE
-------------	-----	-----	-----	-------	------

Packing	1	0.17kg	0.30kg	0.0046	120x30x1300mm
---------	---	--------	--------	--------	---------------

**13.433** For Roll Up 1250mm

SINGLE 1500	QTY	N.W	G.W	C.B.M	SIZE
-------------	-----	-----	-----	-------	------

Packing	1	0.50kg	0.70kg	0.0074	120x40x1550mm
---------	---	--------	--------	--------	---------------

**13.778** For Roll Up 1500mm



## SINGLE OXFORD BAG



## BAG DETAILS



## INFORMATION

\*mm

- Zipper on one side. With ID Pocket.
- Shoulder and hand strap. Double padded



500 | 650 | 850 | 1000

DOUBLE 500	QTY	N.W	G.W	C.B.M	SIZE
------------	-----	-----	-----	-------	------

Packing	1	0.20kg	0.40kg	0.00288	120x40x600mm
---------	---	--------	--------	---------	--------------

**13.494** For Roll Up 500mm

DOUBLE 650	QTY	N.W	G.W	C.B.M	SIZE
------------	-----	-----	-----	-------	------

Packing	1	0.28kg	0.50kg	0.0036	120x40x750mm
---------	---	--------	--------	--------	--------------

**13.495** For Roll Up 650mm

DOUBLE 850	QTY	N.W	G.W	C.B.M	SIZE
------------	-----	-----	-----	-------	------

Packing	1	0.40kg	0.60kg	0.0047	120x40x980mm
---------	---	--------	--------	--------	--------------

**13.463** For Roll Up 850mm

DOUBLE 1000	QTY	N.W	G.W	C.B.M	SIZE
-------------	-----	-----	-----	-------	------

Packing	1	0.50kg	0.70kg	0.0049	120x40x1030mm
---------	---	--------	--------	--------	---------------

**13.464** For Roll Up 1000mm

## DOUBLE PADDED BAG



## BAG DETAILS



## INFORMATION

\*mm

- All crossed zipped.
- Shoulder and hand strap.
- With transparent pocket for ID Tag.



850 | 1000

D.P.ZIPPED 850	QTY	N.W	G.W	C.B.M	SIZE
----------------	-----	-----	-----	-------	------

Packing	1	0.40kg	0.60kg	0.004	120x40x980mm
---------	---	--------	--------	-------	--------------

**13.459** For Roll Up 850mm

D.P.ZIPPED 1000	QTY	N.W	G.W	C.B.M	SIZE
-----------------	-----	-----	-----	-------	------

Packing	1	0.50kg	0.70kg	0.004	120x40x1030mm
---------	---	--------	--------	-------	---------------

**13.460** For Roll Up 1000mm

## DOUBLE PADDED ZIPPED BAG



“ Get an optimal protection for your Roll Up ”

\* Roll Up not included / Roll Up non inclus / Roll Up não incluídos / Roll Up no incluidos.

## SPOTLIGHT DETAILS

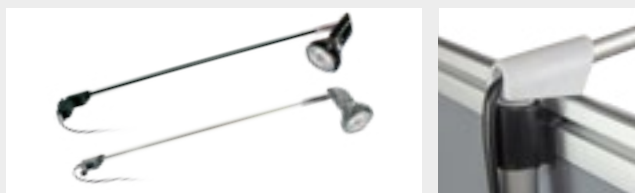

## INFORMATION

\*mm

Spotlights for Roll Up with Plug-in base at top the pole. Bulb type Halogen (included) and directional head, large luminous capacity. Spotlight works directly plugged in. Black or matt aluminium finish.



## PLUG-IN SPOTLIGHT FOR ROLL UP



## SPOTLIGHT DETAILS



## INFORMATION

\*mm

LED light spotlight with clamp adjustment for Roll Up. Works directly plugged in. Chrome finish and 12w LED light. With clamp for quick and easy use.

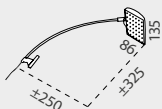

## LED CLAMP SPOTLIGHT FOR ROLL UP



## SPOTLIGHT DETAILS



## INFORMATION

\*mm

60w halogen bulb included. Telescopic (adjustable length). With 2 adapters for tops of the pole (plug-in and cap bases). Ideal to fit most Roll Ups on market. Large luminous capacity.

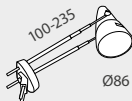

## TELESCOPIC SPOTLIGHT FOR ROLL UP



TELESCOPIC	QTY	N.W	G.W	C.B.M	SIZE
Packing	1	0.30kg	0.35kg	0.0016	125x65x200mm
10.525				60 w	

\* Roll Up not included.

## HANGER DETAILS

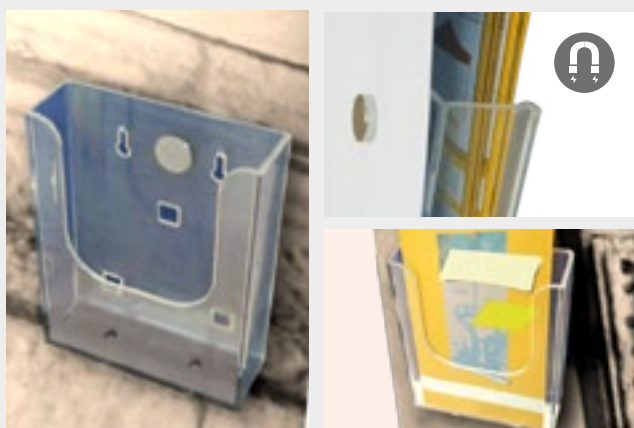

## INFORMATION

\*mm

Acrylic Brochure Holder for A6 leaflet size. Double magnet fixing system. No tools required. Ideal for any Roll Up.

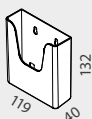

MAGNET DISPENSER	QTY	N.W	G.W	C.B.M	SIZE
Packing	5	0.85kg	0.95kg	0.004	165x130x215mm 
10.860	Graphic Size: A6		x5 		

## MAGNETIC BROCHURE HOLDER



## BAG FOR SPOTLIGHT ROLL UP

### BAG DETAILS

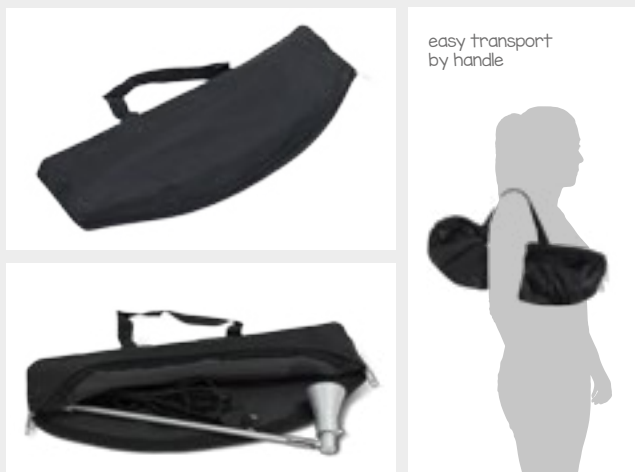

## INFORMATION

\*mm

The Oxford Bag is made of black nylon and all crossed zipped. It protects and extends the life of your Roll Up Spotlights. Easy transport by handle.

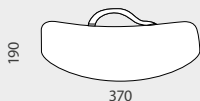

OXFORD BAG	QTY	N.W	G.W	C.B.M	SIZE
Packing	1	0.10kg	0.20kg	0.002	190x30x370mm
13.454					

## GRAPHIC CASE

### CASE DETAILS

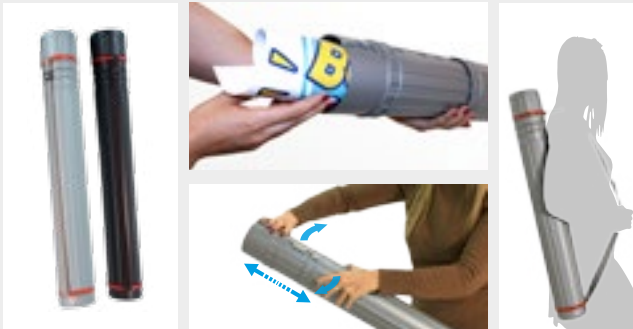

## INFORMATION

Graphics case made of sturdy PVC. Features a shoulder strap for better carrying. Available in two colours (black and grey) and three different sizes.

GRAPHIC CASE 1	QTY	N.W	G.W	C.B.M	SIZE
Uni.	1	0.4kg	0.42kg	0.006	100x100x640mm
10.074		Ø107mm 640-1070mm			
10.075					
GRAPHIC CASE 2	QTY	N.W	G.W	C.B.M	SIZE
Uni.	1	0.5kg	0.52kg	0.008	100x100x780mm
10.076		Ø107mm 779-1280mm			
10.077					
GRAPHIC CASE 3	QTY	N.W	G.W	C.B.M	SIZE
Uni.	1	0.3kg	0.32kg	0.004	80x60x630mm
10.078		Ø85mm 630-1070mm			
10.079					

\* Roll Up not included / Roll Up non inclus / Roll Up não incluídos / Roll Up no incluidos.

DISPLAY DETAILS



INFORMATION

Re-writable and erasable Led Board, Daganzo is available in A4 and A5 format. Featuring 12 modes of bright Neon Effects. It includes rechargeable battery, marker and screen eraser. Daganzo is ideal for promoting upcoming shows, special offers, dinners, special drinks at your bar or restaurant, or at party drawing as notice board and more.

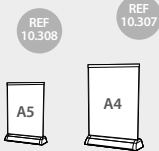

DAGANZO A5	QTY	N.W	G.W	C.B.M	SIZE
Packing	40	7.6kg	15.6kg	0.1	440x420x530mm
Uni.	1	0.19kg	0.39kg	0.003	170x100x220mm
<b>10.308</b>	<b>Graphic Size: A5</b>				
DAGANZO A4	QTY	N.W	G.W	C.B.M	SIZE
Packing	20	13.0kg	26.0kg	0.09	480x360x540mm
Uni.	1	0.65kg	1.30kg	0.05	260x100x340mm
<b>10.307</b>	<b>Graphic Size: A4</b>				

DAGANZO  
LED WRITING BOARD

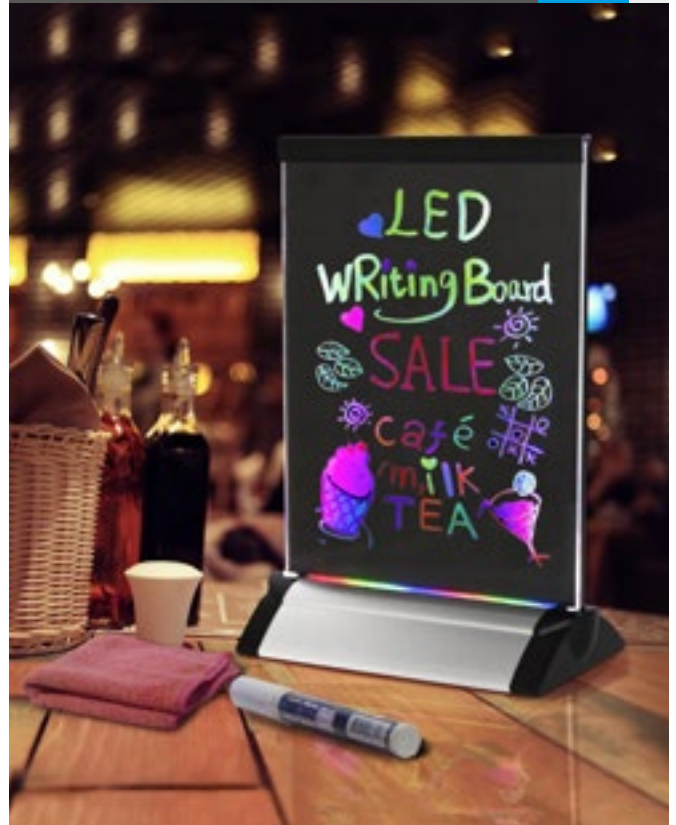

DISPLAY DETAILS



INFORMATION

This portable and retractable display for Interchangeable graphics is made of aluminium and plastic parts. It is available in 2 sizes: A3 and A4. Ideal for promoting, special offers or for promoting business.



TORRICO A4	QTY	N.W	G.W	C.B.M	SIZE
Packing	50	15kg	17kg	0.0656	525x250x500mm
Uni.	1	0.3kg	0.4kg	0.001	90x45x260mm
<b>10.787</b>	<b>Graphic Size: A4</b>				
TORRICO A3	QTY	N.W	G.W	C.B.M	SIZE
Packing	50	17.5kg	19kg	0.0881	705x250x500mm
Uni.	1	0.35kg	0.6kg	0.0014	90x45x345mm
<b>10.786</b>	<b>Graphic Size: A3</b>				

TORRICO  
MINI ROLL UP



DISPLAY DETAILS



INFORMATION

\*mm

Mini Flying Banner with steel base and fiberglass flag pole. It is recommendable to print the graphic part on textile. Ideal for promotional use on counters or desks. Graphic printing not included.

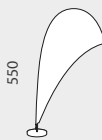

KRAKOW	QTY	N.W	G.W	C.B.M	SIZE
Packing	1	0.30kg	0.35kg	0.0003	30x12x850mm
10.596	Graphic Size: 550mm (Height)				

KRAKOW  
MINI FLYING



DISPLAY DETAILS



INFORMATION

\*mm

Mini X-Banner with fiberglass structure and plastic parts. It offers the possibility of exchanging the graphics easily. Ideal for promotional use on counters or desks.



TORDESILLAS	QTY	N.W	G.W	C.B.M	SIZE
Packing	200	10kg	14kg	0.07	380x140x500mm
Uni.	1	0.05kg	0.05kg	0.00045	45x35x285mm
10.009	Graphic Size: 220x400mm				

TORDESILLAS  
MINI X-BANNER



## DISPLAY DETAILS



## INFORMATION

\*mm

Double sided banner display made of durable aluminium and plastic parts. Easy to assemble and graphic change. Carry bag is included. Ideal for trade shows, expositions, retail stores or any media event.

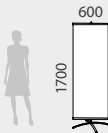

TORMES	QTY	N.W	G.W	C.B.M	SIZE
Packing	10	14.50kg	18kg	0.08	340x240x980mm
Uni.	1	1.45kg	1.80kg	0.007	85x85x930mm
10.010	Graphic Size: 600x1700mm				

## TORMES CROSS BANNER



## DISPLAY DETAILS



## INFORMATION

\*mm

Double sided banner display made of durable aluminium and plastic parts. Easy to assemble and graphic change. Carry bag is included. Ideal for trade shows, expositions, retail stores or any media event.

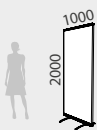

ALMEIDA	QTY	N.W	G.W	C.B.M	SIZE
Packing	10	26kg	29kg	0.11	340x240x1280mm
Uni.	1	2.60kg	2.90kg	0.014	120x100x1170mm
10.708	Graphic Size: 1000x2000mm				

## ALMEIDA CROSS BANNER



## DISPLAY DETAILS

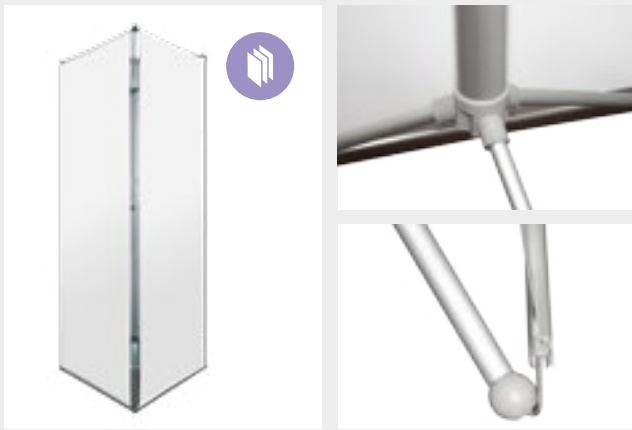

## INFORMATION

\*mm

Triple sided banner display made of durable aluminium structure and plastic parts. Easy to assemble and change graphics. Carry bag is included.



GALENDE	QTY	N.W	G.W	C.B.M	SIZE
Packing	5	14kg	16kg	0.064	400x150x1080mm
Uni.	1	2.65kg	3.05kg	0.016	160x160x650mm
10.012	Graphic Size: 915x2150mm (x3)				

## GALENDE TRIPLE BANNER



## DISPLAY DETAILS



## INFORMATION

This display features 4 folding sections for storage with 8 double sided panels (total one side: 2400x1800mm). Included carrying bag for an easy transporting. Grey RAL 9006 color.

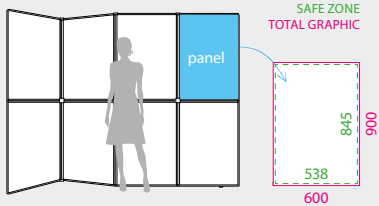

ARENAS	QTY	N.W	G.W	C.B.M	SIZE
Packing	1	7.3kg	11kg	0.12	640x200x950mm
10.041	Graphic Size: 2400x1800mm				

## ARENAS EXHIBITION WALL



## DISPLAY DETAILS



## DIMENSIONS \*mm

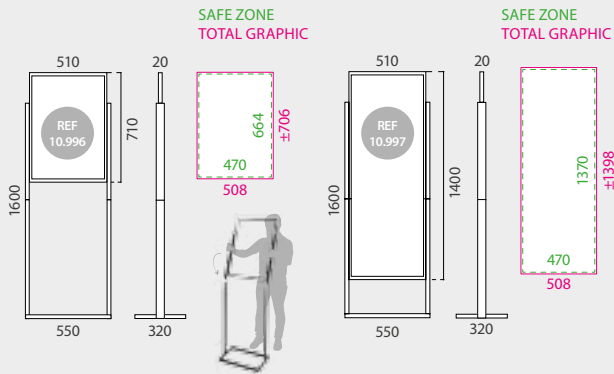
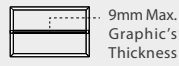

## INFORMATION

These solid Displays are made of steel and they are black painted, featuring two different graphic size available. Slide the poster (9mm max. thickness) into the groove and display it back-to-back in high traffic areas.

STEEL D 1	QTY	N.W	G.W	C.B.M	SIZE
Packing	1	10.03kg	11.20kg	0.066	570x145x805mm
<b>10.996</b>	<b>Graphic Size: 508 x ±706mm</b>				
STEEL D 2	QTY	N.W	G.W	C.B.M	SIZE
Packing	1	11.30kg	12.47kg	0.066	570x145x805mm
<b>10.997</b>	<b>Graphic Size: 508 x ±1398mm</b>				

## STEEL STAND DISPLAY





DISPLAY DETAILS

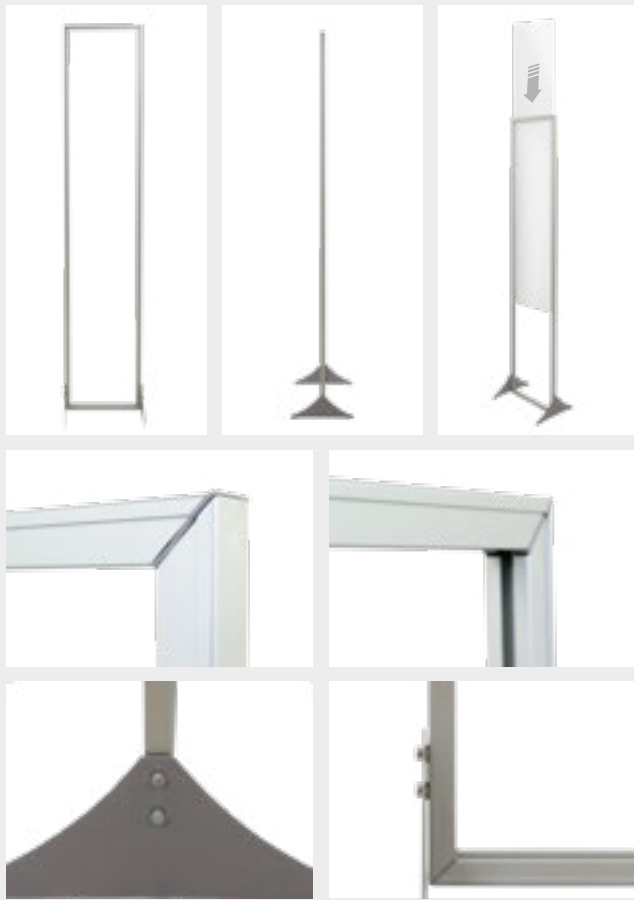

DIMENSIONS

ARTWORK \*mm

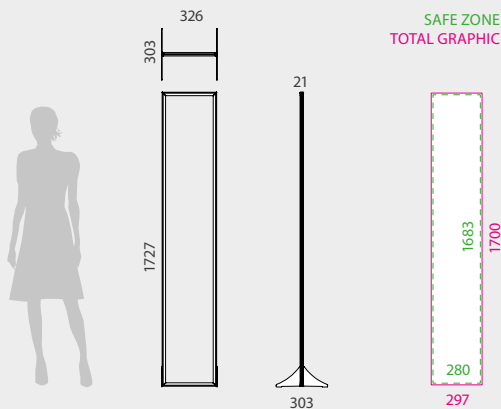

INFORMATION

Aluminium Banner Display is lacquered in gray RAL 9006 and features an easy to load and upload system. With an easy glide for the 1700mm height graphic poster (5mm max.thickness) into the metal grooves of the structure and display it back-to-back in high traffic areas. This Aluminium Banner Display is ideal for displaying at mall's corridors, for promoting at trade shows, outside your office or showroom.

A.BANNER.D.	QTY	N.W	G.W	C.B.M	SIZE
Packing	1	1.8kg	2.32kg	0.0205	1745x335x35mm
13.643	Graphic Size: 297x1700mm				

ALUMINIUM BANNER DISPLAY

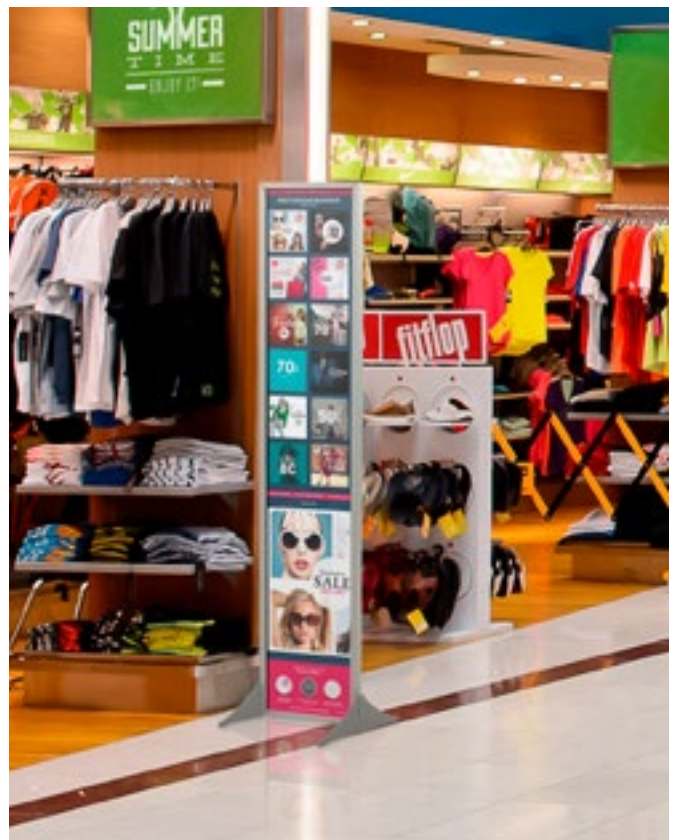
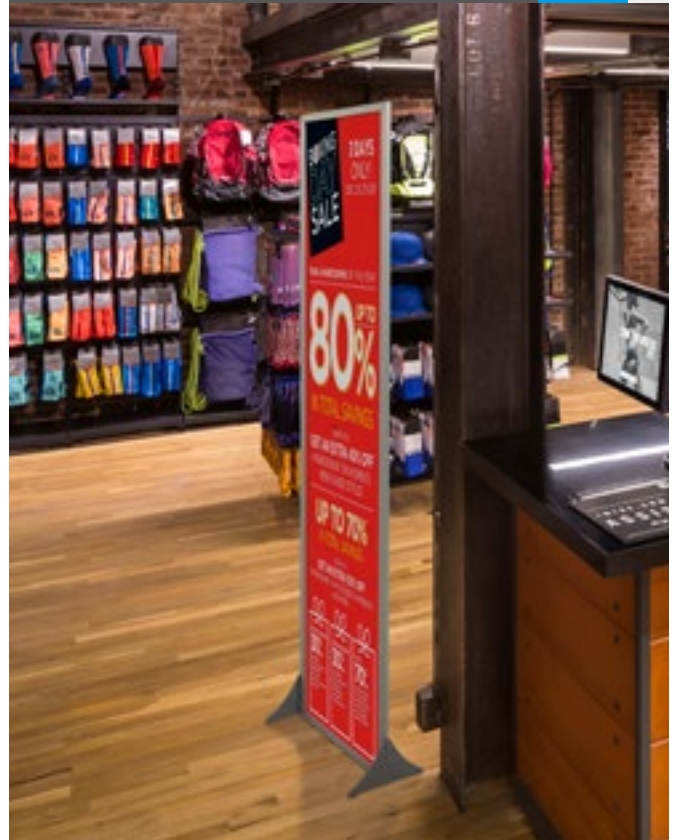

## DISPLAY DETAILS



## DIMENSIONS

## ARTWORK \*mm

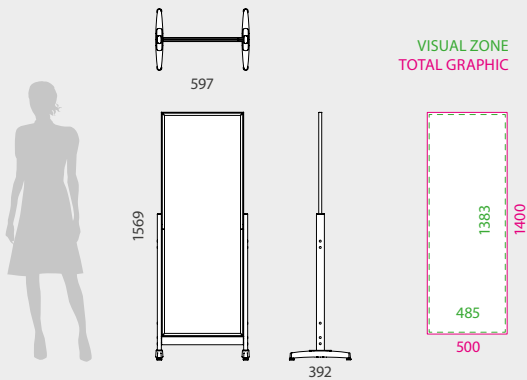

## INFORMATION

Aluminium Stand Display lacquered in gray RAL 9006, featuring an easy to load and upload system. With adjustable stability sturdy feet and an easy glide for the 1400mm height graphic poster (9mm max.thickness) into the metal grooves of the structure and display it back-to-back. Ideal for promoting at trade shows, retail stores, fair stands, showrooms, travel agencies or offices.

A STAND D.	QTY	N.W	G.W	C.B.M	SIZE
Packing	1	4.47kg	5.54kg	0.0436	880x660x75mm
13.736	Graphic Size: 500x1400mm				

## ALUMINIUM STAND DISPLAY



## DISPLAY DETAILS

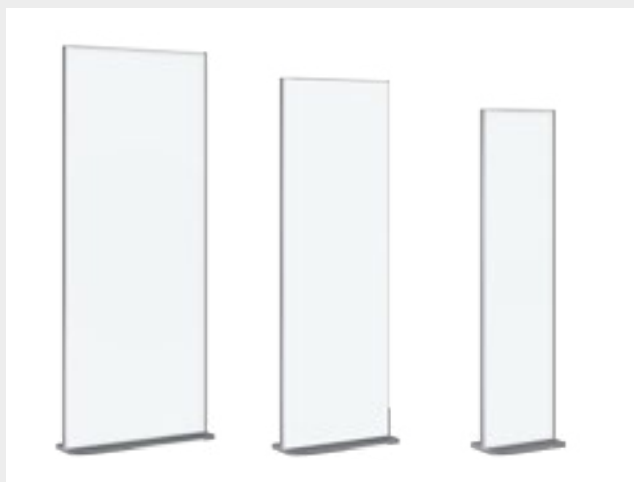

## DIMENSIONS

\*mm

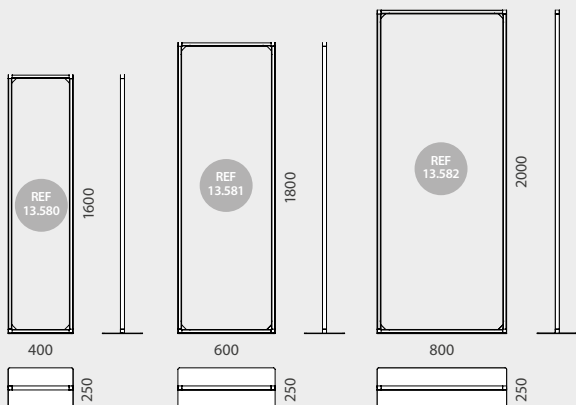

## INFORMATION

This closed frame support is made of aluminium and it is suitable for PVC graphic posters, fixed with magnetic tape. Also, it features a stylish and sturdy flat base. Media Frame is ideal for using during a variety of promotional events, such as a trade shows, media events, exhibitions or even as solution for a photocall.

MEDIA F.	QTY	N.W	G.W	C.B.M	SIZE
MEDIA F. 400	1	7.5kg	8kg	0.0178	410x860x60mm
<b>13.580</b>	<b>Graphic Size: 400x1600mm</b>				
MEDIA F.	QTY	N.W	G.W	C.B.M	SIZE
MEDIA F. 600	1	10kg	11kg	0.0295	610x950x60mm
<b>13.581</b>	<b>Graphic Size: 600x1800mm</b>				
MEDIA F.	QTY	N.W	G.W	C.B.M	SIZE
MEDIA F. 800	1	13kg	14kg	0.0436	1070x810x60mm
<b>13.582</b>	<b>Graphic Size: 800x2000mm</b>				

## MEDIA FRAME



\* PVC sheet and magnetic tape not included.

## DISPLAY DETAILS



## DIMENSIONS

## ARTWORK

\*mm

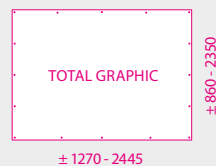
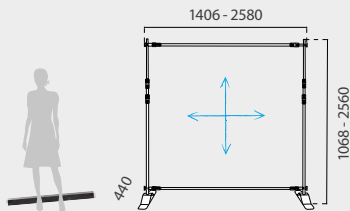

## INFORMATION

With structure made of steel and black laquered. This portable and double-sided banner is ideal for using during a variety of promotional events, such as a trade show, media event, tradeshow exposition or even as solution for a photocall. Each pipe is also designed for an easy and fast telescopic adjustment of the display, allowing the use of graphs of different widths and heights. Vilamoura banner is a display fast to assemble and easy to transport. Adjustable height and width structure. Minimum graphic size:  $\pm$  Height 860 x Width 1270mm. Maximum graphic size:  $\pm$  Height 2350 x Width 2445mm.

VILAMOURA	QTY	N.W	G.W	C.B.M	SIZE
Packing	2	11kg	12kg	0.031	140x170x1380mm
Uni.	1	5.5kg	6kg	0.015	70x170x1380mm
10.498		Graphic Size: 1270-2445x860-2350mm			

## VILAMOURA EXTENSION BANNER



## DISPLAY DETAILS

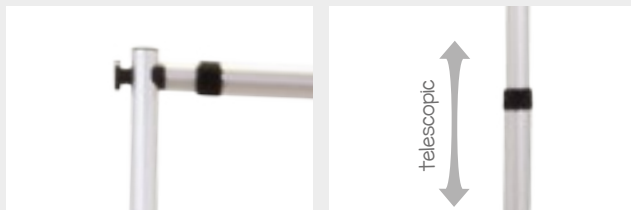

## DIMENSIONS

## ARTWORK

\*mm

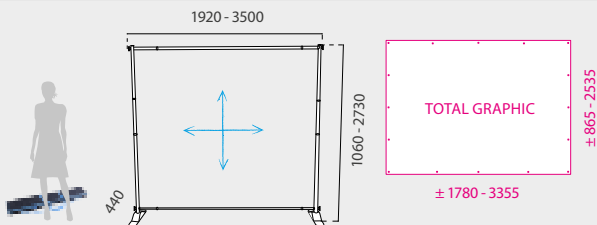

## INFORMATION

With structure made of aluminium and plastic. Available black or silver finishing. This portable and double-sided banner is ideal for using during a variety of promotional events, such as a trade show, media event, tradeshow exposition or even as solution for a photocall. Each pipe is also designed for an easy and fast telescopic adjustment of the display, allowing the use of graphs of different widths and heights. Vilamoura XXL banner is a big size display fast to assemble and easy to transport, ideal for any promotional event that your business requires. Adjustable height and width structure. Minimum graphic size:  $\pm$  Height 1315 x Width 1780mm. Maximum graphic size:  $\pm$  Height 2535 x Width 3355mm.

VILAMOURA XXL	QTY	N.W	G.W	C.B.M	SIZE
Packing	1	7kg	8.1kg	0.0266	230x110x1050vmm
13.752	 	Graphic Size: 1780-3355x865-2535mm			

## VILAMOURA XXL EXTENSION BANNER



## DISPLAY DETAILS



### INFORMATION

### DIMENSIONS

### ARTWORK \*mm

This double sided Poster Display is made of metal, suitable for 2 exhibitions of graphics. It features a telescopic pole (adjustable height of 1000-1600mm).

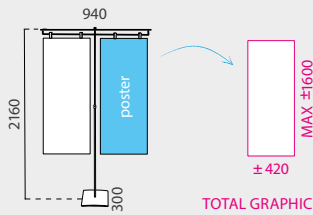

ALGORA	QTY	N.W	G.W	C.B.M	SIZE
Packing	1	1.2kg	1.6kg	0.02	270x70x1200mm
10.803	Graphic Size: ±420x1000-1600mm (x2)				

## ALGORA



## DISPLAY DETAILS



### INFORMATION

### DIMENSIONS

### ARTWORK \*mm

Oropesa Poster Display is made of metal, featuring a special design for an optimum storage. Also, it has a telescopic pole with adjustable height (1100-2100mm). Ideal for promoting your business, such as trade shows and promotional events at stores or business presentations.

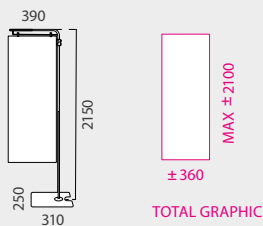

OROPESA	QTY	N.W	G.W	C.B.M	SIZE
Packing	1	1.96kg	2.53kg	0.05	410x118x1185mm
10.432	Graphic Size: ±360x1100-2100mm				

## OROPESA



DISPLAY DETAILS



INFORMATION

\*mm

This portable and detachable display stand features a water refillable base, 6 litres capacity. Made of fiberglass, plastic and lacquered aluminium. Suitable for indoor and outdoor use, features an easy interchange of graphics. Carry bag is included.

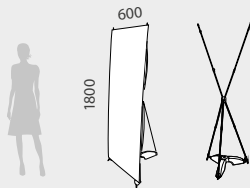

ALMAZAN	QTY	N.W	G.W	C.B.M	SIZE
Pole	1	0.55kg	0.6kg	0.004	80x65x750mm
Base	1	0.95kg	1kg	0.015	250x170x350mm
10.028	Graphic Size: 600x1800mm				



ALMAZAN



DISPLAY DETAILS



INFORMATION

\*mm

This portable and detachable display stand features a water refillable base, 6 litres capacity. Made of fiberglass, plastic and lacquered aluminium. Suitable for indoor and outdoor use, features an easy interchange of graphics and adjustable height (telescopic). Carry bag is included.

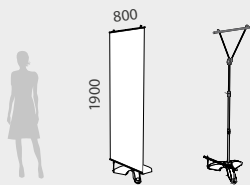

ALMENAR	QTY	N.W	G.W	C.B.M	SIZE
Packing	6	13kg	16.20kg	0.1	400x320x850mm
Uni.	1	1.8kg	2.2kg	0.02	240x100x840mm
10.029	Graphic Size: 800x1900mm				



ALMENAR



DISPLAY DETAILS

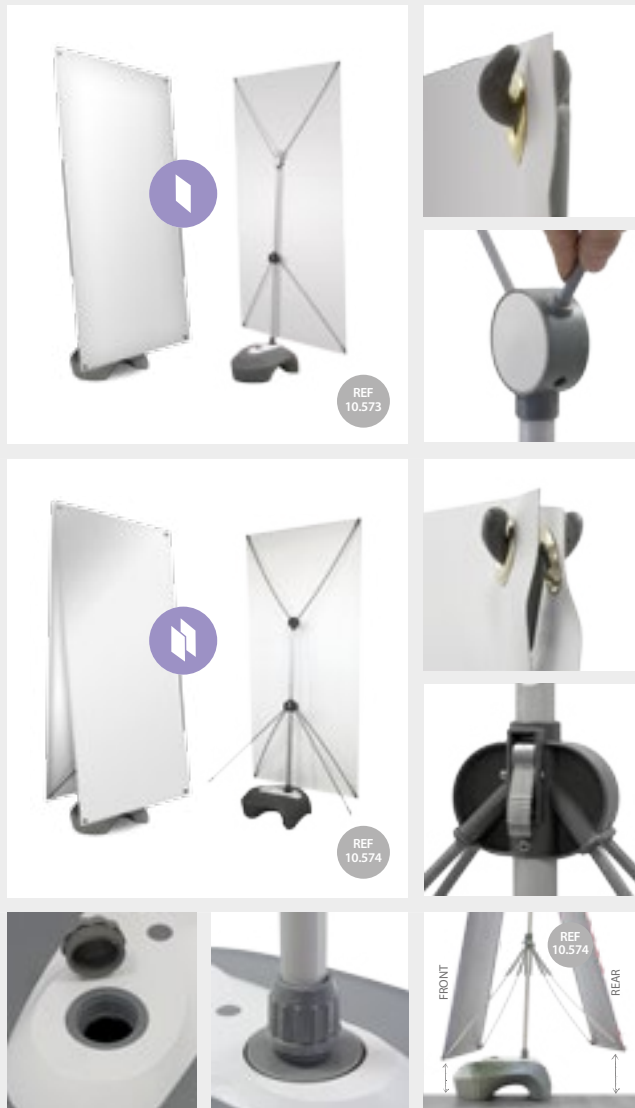

INFORMATION

\*mm

This stand display features a 20l water refillable base. The central telescopic hub allows fast height adjustment. Kiel is ideal for indoor or outdoor promotion, and as it can be used to present a double-sided graphic (ideal for areas with 2-ways traffic). Graphics are held with a simple and fast eyelet system. In double-sided Kiel 10.574, after the placement of graphs, the distance to the ground on both sides can differentiate each other: ± 50mm.

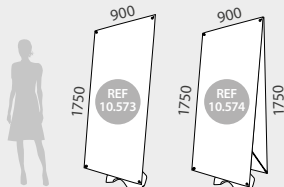

KIEL SINGLE	QTY	N.W	G.W	C.B.M	SIZE
Packing	1	2.8kg	3.25kg	0.09	400x200x1080mm
10.573	Graphic Size: 900x1750mm				
KIEL DOUBLE	QTY	N.W	G.W	C.B.M	SIZE
Packing	1	3kg	3.45kg	0.09	400x200x1080mm
10.574	Graphic Size: 900x1750mm x2				

KIEL





## DISPLAY DETAILS



## INFORMATION

\*mm

Medinaceli is a detachable stand display with a refillable 12L water plastic base which is suitable for indoor and outdoor use. The change of graphic is simple and takes only a few seconds. Includes a nylon Carry Bag for an easy transport and storing.

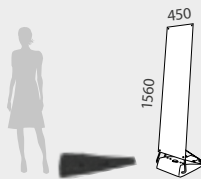

MEDINACELLI	QTY	N.W	G.W	C.B.M	SIZE
Packing	2	7kg	8.6kg	0.11	540x190x1050mm
Uni.	1	2.85kg	3.50kg	0.05	500x100x1030mm
10.026	Graphic Size: 450x1560mm				

## MEDINACELI



## BASE DETAILS

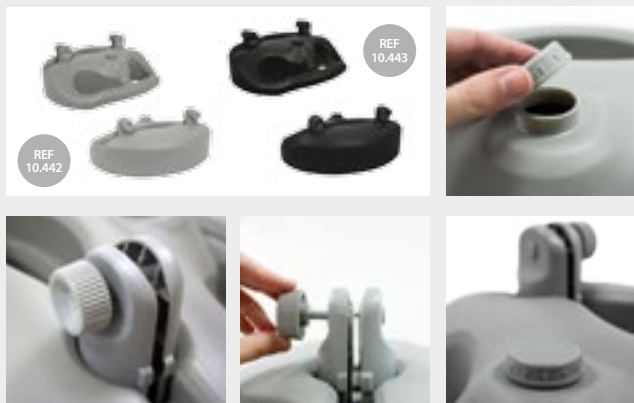



## INFORMATION

\*mm

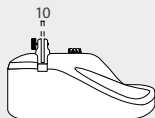
With a durable design and easy portability, this double-sided base with corrugated plastic insert is ideal for placing outdoors, in areas with high foot traffic to draw in new customers. The weighted poster holder can be filled with up to 5l of water or sand. This base is available on Grey or black color.



PANELFIX WING	QTY	N.W	G.W	C.B.M	SIZE
Packing	1	2kg	2.55kg	0.04	440x190x520mm
10.442					
10.443					

## PANELFIX WING OUTDOOR



\* Board are available but not included. The price includes only the base.

## BASE DETAILS



## INSTALL EXPLANATION FOR PANELS UP TO 18mm

1. Place the profile below.
2. Adjust the profile with wheel at the bottom of the PanelFix Wing Aluminium.
3. Max. thickness: 18mm.
4. Place the graphic panel into the slot and adjust it with the wheel until it is properly fixed.

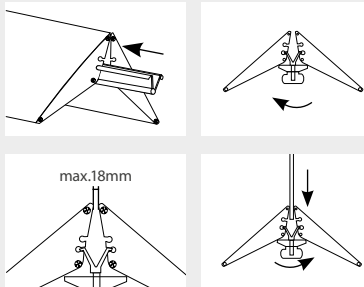

## INSTALL EXPLANATION FOR PANELS UP TO 26mm

1. Place the profile above.
2. Adjust the profile with wheel at the bottom of the PanelFix Wing Aluminium.
3. Max. thickness: 26mm.
4. Place the graphic panel into the slot and adjust it with the wheel until it is properly fixed.

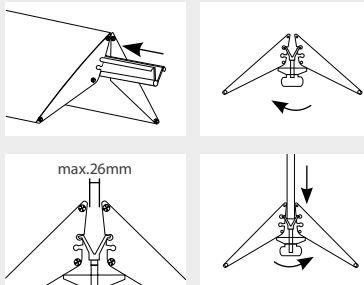

## INFORMATION

The PanelFix Wing base made of aluminium is available in three sizes 200, 350 or 550mm and two colors: black or silver. It is designed to hold rigid graphs, allowing the fixing of supports up to 26mm thickness. Also, it allows the printing of any logo on both sides of the base. The double-sided signs help to draw more potential customer coming from both directions into your business.

PF	AL	QTY	N.W	G.W	C.B.M	SIZE
	200	Packing 1	1.1kg	1.5kg	0.0069	315x93x235mm
10.828		Width: 200mm				
10.829						
PF	AL	QTY	N.W	G.W	C.B.M	SIZE
	350	Packing 1	2.6kg	3kg	0.0113	315x93x385mm
10.877		Width: 350mm				
10.869						
PF	AL	QTY	N.W	G.W	C.B.M	SIZE
	550	Packing 1	4.15kg	4.6kg	0.0171	315x93x585mm
10.880		Width: 550mm				
10.870						

## PANELFIX WING ALUMINIUM



## BASE DETAILS



## DIMENSIONS

\*mm

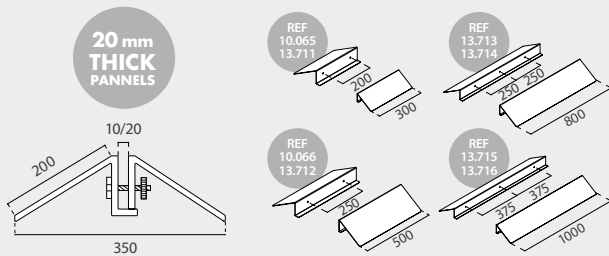

## INFORMATION

The Panelfix Wing is a display base made of steel with four available sizes from 300 up to 1000mm and two colors for each size: black or gray. It is designed to hold rigid graphs, allowing the fixing of supports up to 20mm thickness (the max. recommended height is 1500mm). Also, it allows the printing of any logo on both sides of the base. The double-sided signs help to draw more potential customer coming from both directions into your business. The steel base of this sign holder are sturdy enough for multiple uses and years to come, from a crowded trade show floor to a fast paced retail store.

PFIX 300	QTY	N.W	G.W	C.B.M	SIZE
Packing	1	2.75kg	2.95kg	0.0069	210x100x330mm
10.065		Grey	Width: 300mm		
13.711		Black			
PFIX 500	QTY	N.W	G.W	C.B.M	SIZE
Packing	1	4.55kg	4.85kg	0.0111	530x210x100mm
10.066		Grey	Width: 500mm		
13.712		Black			
PFIX 800	QTY	N.W	G.W	C.B.M	SIZE
Packing	1	7.15kg	7.95kg	0.0243	830x255x115mm
13.713		Grey	Width: 800mm		
13.714		Black			
PFIX 1000	QTY	N.W	G.W	C.B.M	SIZE
Packing	1	8.85kg	9.85kg	0.0302	1030x255x115mm
13.715		Grey	Width: 1000mm		
13.716		Black			

## PANELFIX WING STEEL



\* Boards are available but not included. The price includes only the base.

## BASE DETAILS



## DIMENSIONS

\*mm

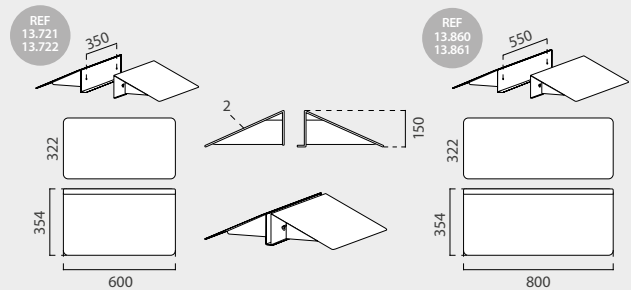

## INFORMATION

This base is made of steel sheet of 2mm thickness and it is available in two widths (600 mm and 800mm). It features black laquered (RAL 9005) or grey laquered (RAL 9006). The XL Steel base is ideal to hold rigid materials up to 19mm thickness. The maximum recommended height for the graphic panel is 2000mm. Specially designed for supporting big graphic panels thanks to its weight. This base is a simple clip holder system that grips a board between the two sides to help businesses advertise their products and services. Ideal as a sleek, professional alternative to bulky A-frame Board poster stands.

PFIX XL 600	QTY	N.W	G.W	C.B.M	SIZE
Packing	1	11.85kg	12.55kg	0.0486	400x190x640mm
13.721		Grey	600x663x150mm		
13.722		Black			
PFIX XL 800	QTY	N.W	G.W	C.B.M	SIZE
Packing	1	14.25kg	15kg	0.064	400x190x840mm
13.860		Grey	800x663x150mm		
13.861		Black			

**new**

## PANELFIX WING STEEL XL



\* Boards are available but not included. The price includes only the base.

BASE DETAILS



DIMENSIONS

\*mm

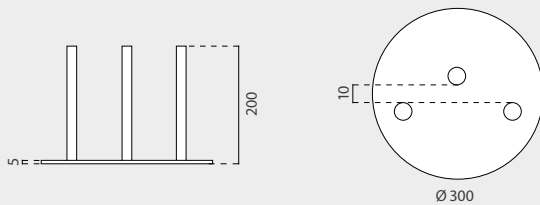

INFORMATION

The Montijo Poster Display is a Ø300mm base made of 5mm thickness steel sheet. It is 200mm height and is available in black or white colored. It is ideal for holding rigid materials up to 10mm thickness and includes anti-scratch felt pads at bottom. The double-sided signs help to draw more potential customer coming from both directions into your business. The steel base of this sign holder are sturdy enough for multiple uses and years to come, from a crowded trade show floor to a fast paced retail store.

MONTIJO	QTY	N.W	G.W	C.B.M	SIZE
Packing	2	7.2kg	7.75kg	0.024	310x250x310mm
10.898	<input checked="" type="checkbox"/>	Size: Ø300x200mm x2 			
10.838	<input type="checkbox"/>				

MONTIJO



\* Boards are available but not included. The price includes only the base.

BASE DETAILS

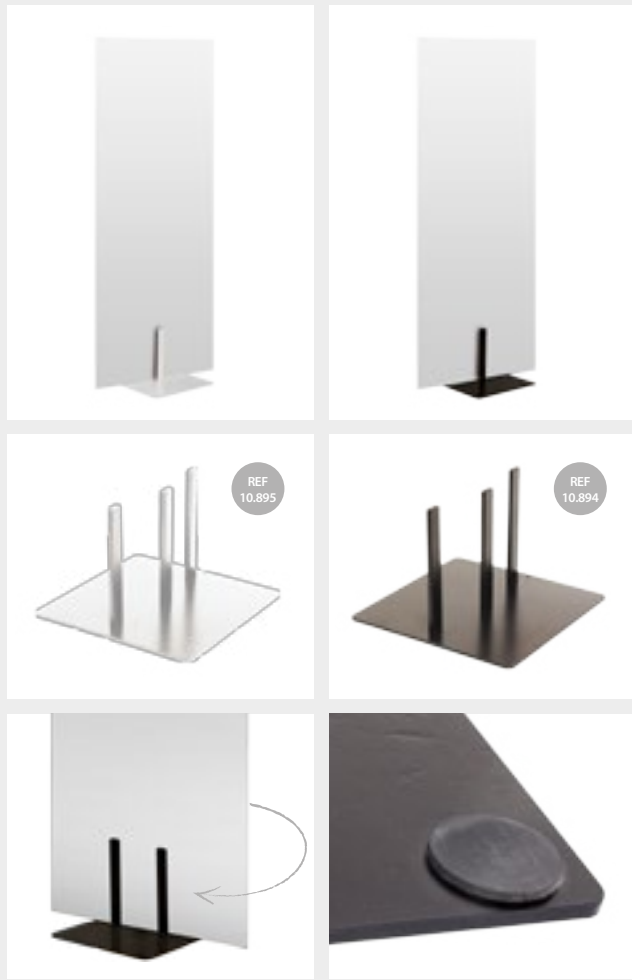

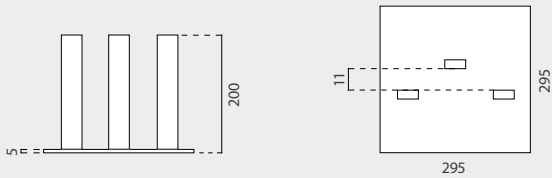

DIMENSIONS

\*mm



INFORMATION

This base is made of 5mm thickness steel sheet. It features anti-scratch felt pads at bottom. Available in black or white colored. The steel base of this sign holder are sturdy enough for multiple uses and years to come, from a crowded trade show floor to a fast paced retail store. The Balboa base is ideal to hold rigid materials up to 11mm thickness.

BALBOA	QTY	N.W	G.W	C.B.M	SIZE
Packing	2	9.00kg	9.60kg	0.024	310x250x310mm
10.894		295x200x295mm		x2	
10.895					

BALBOA



\* Boards are available but not included. The price includes only the base.

## BASE DETAILS

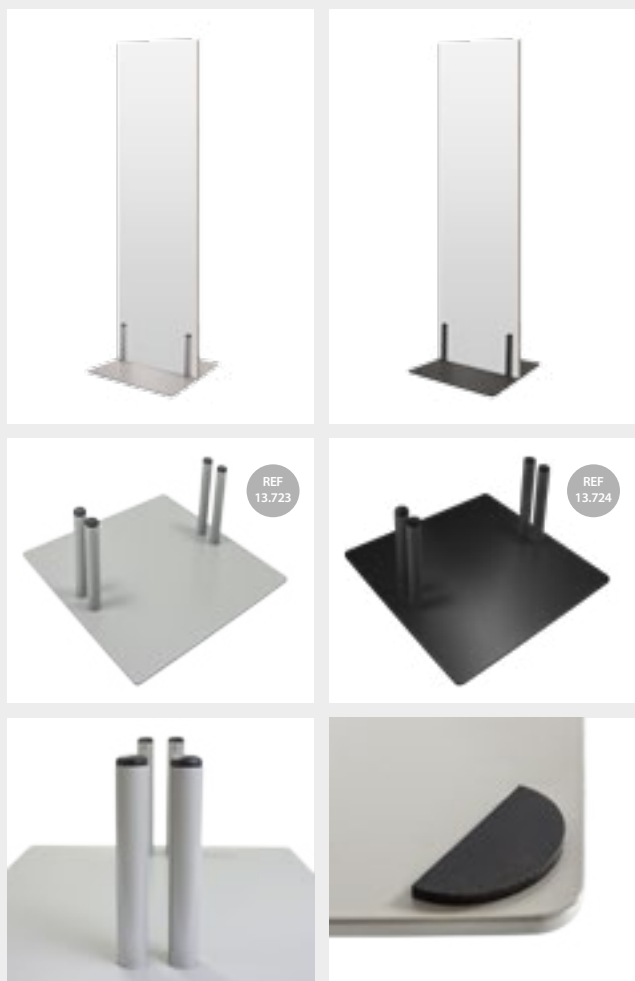

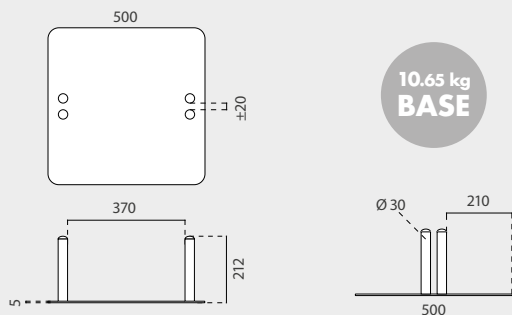

## DIMENSIONS

\*mm



## INFORMATION

The Balboa XL is made of steel sheet of 5mm thickness. It features black laquered (RAL 9005) or grey laquered (RAL 9006) finish. This XL Steel base is ideal to hold rigid materials up to 19mm thickness. Specially designed for supporting big graphic panels (2000mm max. height recommended) thanks to its 10.65kg.

BALBOA XL	QTY	N.W	G.W	C.B.M	SIZE
Packing	1	11.30kg	12.10kg	0.0772	545x545x260mm
13.723		Grey	500x212x500mm		
13.724		Black			

## BALBOA XL



\* Boards are available but not included. The price includes only the base.



click



Click Boards

## SIDEWALK DETAILS



## SIDEWALK DETAILS

## GRAPHIC BY CLICK FRAME



## DIMENSIONS

\* W: Width H: Height D: Depth \* mm

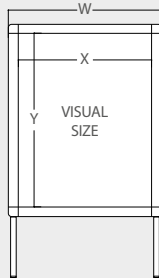
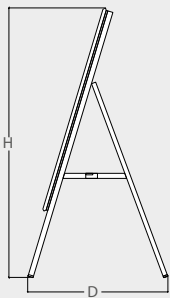

click

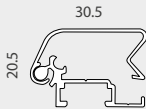

## INFORMATION

This frame board is made of aluminum so it is lightweight and resistant to rusting. It has a 30.5mm width profile with click system, so the graphic change is quick and simple. With its single-sided folding frame, Niza A-Board is ideal for advertising outside your store, like restaurants, street stalls or supermarkets. It includes a weather resistant antireflection sheet so is also non-glare which allows it to be read under bright lights.

## NIZA



NIZA	QTY	N.W	G.W	C.B.M	Size (WxHxD)
Packing	1	5kg	7kg	0.075	580x1080x120
	Visual (X-Y)		External (WxHxD)		
Product	485x685		540x1060x440		
10.808	Graphic Size: 500x700mm				



## SIDEWALK DETAILS



## DIMENSIONS

\* W: Width H: Height D: Depth \* mm

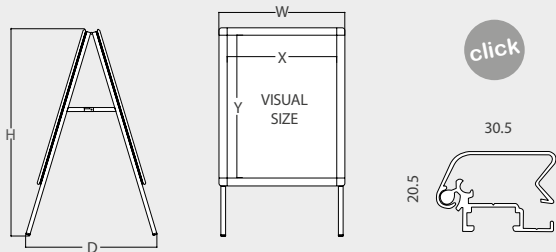

## INFORMATION

Bayonne Sidewalk is made of aluminum so it is lightweight and resistant to rusting. It has feet protection to avoid slipping and a 30.5mm width profile with click system, so the graphic change is fast and simple. Also, it includes a weather resistant antireflection sheet so is also non-glare which allows it to be read under bright lights. With its 2-sided folding frame, The Bayonne Sidewalk is ideal for advertising sales inside or outside your store.

H700	QTY	N.W	G.W	C.B.M	Size (WxHxD)
Packing	1	4.85kg	6.5kg	0.068	509x1120x120
		Visual (X-Y)	External (WxHxD)		
Product	485x685	545x1030x532			

**10.804** Graphic Size: 500x700mm

H1000	QTY	N.W	G.W	C.B.M	Size (WxHxD)
Packing	1	7.64kg	9.6kg	0.127	795x1400x115
		Visual (X-Y)	External (WxHxD)		
Product	687x988	745x1330x605			

**10.805** Graphic Size: 700x1000mm

A1	QTY	N.W	G.W	C.B.M	Size (WxHxD)
Packing	1	6.7kg	8.5kg	0.101	695x1220x120
		Visual (X-Y)	External (WxHxD)		
Product	580x830	640x1170x540			

**13.145** Graphic Size: A1

A0	QTY	N.W	G.W	C.B.M	Size (WxHxD)
Packing	1	10.2kg	12.45kg	0.175	930x1575x120
		Visual (X-Y)	External (WxHxD)		
Product	825x1170	885x1520x585			

**13.146** Graphic Size: A0

## BAYONNE



## ANTIREFLECTION SHEET

- EN Antireflection sheet for snapframe.
- FR Antireflet pour cadres ou chevalets.
- PT Película antirreflexo para marcos e caveletes.
- ES Antireflex para marcos y caballetes.



SHEET

SIZE

10.952	500x700mm
10.953	700x1000mm
10.992	A1   598x838mm
10.993	A0   838x1188mm

## SIDEWALK DETAILS

## GRAPHIC BY CLICK FRAME



## INFORMATION

\* W: Width H: Height D: Depth \* mm

Grenoble is a small dimensions A-frame aluminium board. It is lightweight and resistant to rusting. It has a 32mm click system profile. Grenoble is ideal for advertising events, menus or last offers outside your shop. Includes a weather resistant antireflection sheet.

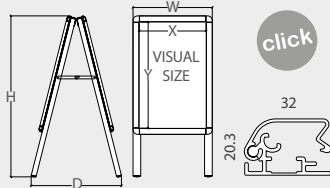

click

GRENOBLE	QTY	N.W	G.W	C.B.M	Size (WxHxD)
Packing	1	4.3kg	5kg	0.0374	425x880x100
		Visual (X-Y)	External (WxHxD)		
Product	341x541	404x815x456			
10.942	Graphic Size: 340x540mm				

## GRENOBLE



## SIDEWALK DETAILS

## GRAPHIC BY CLICK FRAME



25mm

## INFORMATION

\* W: Width H: Height D: Depth \* mm

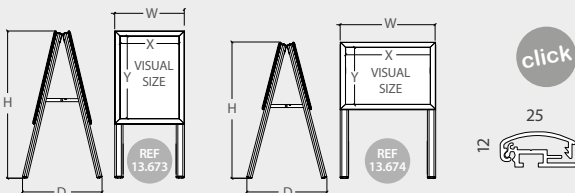

click

Poisat is a small dimensions aluminium A-frame Board. It is lightweight and resistant to rusting. It has a 25mm width click system profillet. Ideal for advertising your upcoming events, shows, menu or last offers at your show window. It includes a weather resistant antireflection sheet.

PORTRAIT	QTY	N.W	G.W	C.B.M	Size (WxHxD)
Packing	1	2.77kg	3.298kg	0.0244	340x715x85
		Visual (X-Y)	External (WxHxD)		
Product	279x402	332x699x379			
13.673	Graphic Size: A3 Portrait				
LANDSCAPE	QTY	N.W	G.W	C.B.M	Size (WxHxD)
Packing	1	2.63kg	3.257kg	0.0308	460x670x85
		Visual (X-Y)	External (WxHxD)		
Product	279x402	455x648x381			
13.674	Graphic Size: A3 Landscape				

## POISAT



# SIDEWALK BOARDS Click Boards

## SIDEWALK DETAILS

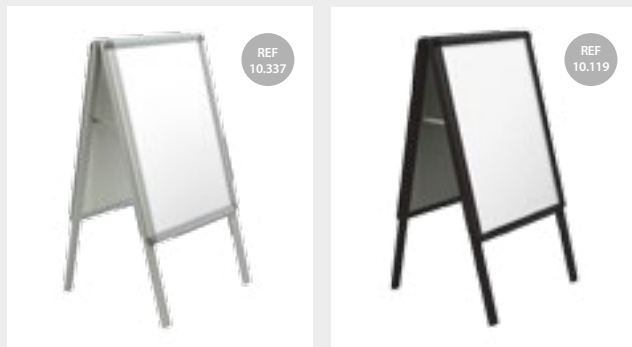

## INFORMATION

\* W: Width H: Height D: Depth \* mm

Merida has a 32mm width aluminium profile with click system, so it is lightweight and resistant to rusting. Merida has feet protections to avoid slipping and a weather resistant antireflection sheet included. It is ideal for being used inside or outside of your business.

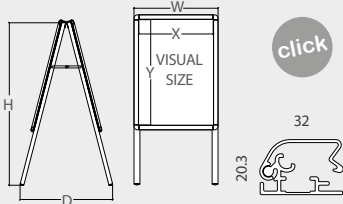

[click](#)

## RAL COLORS AVAILABLE



MERIDA A1	QTY	N.W	G.W	C.B.M	Size (WxHxD)
Packing	1	7.92kg	9.69kg	0.098	660x1420x105
		Visual (X-Y)	External (WxHxD)		
Product		575x822	638x1400x698		GRAPHIC SIZE
10.337					A1
10.119					

MERIDA H700	QTY	N.W	G.W	C.B.M	Size (WxHxD)
Packing	1	5.64kg	6.7kg	0.072	575x1100x115
		Visual (X-Y)	External (WxHxD)		
Product		481x681	544x1050x598		GRAPHIC SIZE
10.338					500x700mm
10.122					

MERIDA H1000	QTY	N.W	G.W	C.B.M	Size (WxHxD)
Packing	1	8.94kg	10.67kg	0.127	765x1445x115
		Visual (X-Y)	External (WxHxD)		
Product		681x981	744x1400x799		GRAPHIC SIZE
10.339					700x1000mm
10.124					

MERIDA

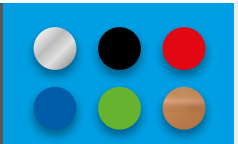

## SIDEWALK DETAILS \* mm GRAPHIC BY CLICK FRAME

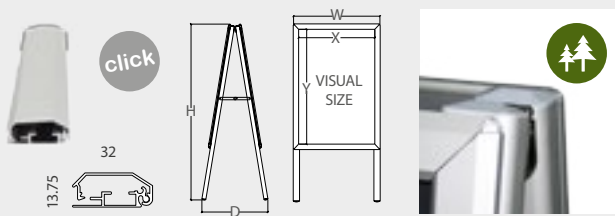

### INFORMATION

The Dijon Sidewalk is designed for outdoor use so it's perfect for advertising outside or inside your store. It has a 32mm width aluminium profile with click system, so the graphic change is quick and simple. Thanks to its double-sided frame is ideal for displaying offers, menus, information maps, etc. It includes a weather resistant antireflection sheet.

DIJON H700	QTY	N.W	G.W	C.B.M	Size (WxHxD)
Packing	1	5kg	6.5kg	0.0877	580x1120x135
		Visual (X-Y)	External (WxHxD)		
Product	478x678		542x1038x414		

**10.558** Graphic Size: 500x700mm

DIJON AI	QTY	N.W	G.W	C.B.M	Size (WxHxD)
Packing	1	6.4kg	8.5kg	0.0984	660x1420x105
		Visual (X-Y)	External (WxHxD)		
Product	572x819		636x1382x536		

**10.557** Graphic Size: A1

DIJON HI000	QTY	N.W	G.W	C.B.M	Size (WxHxD)
Packing	1	7.9kg	9.65kg	0.1562	790x1465x135
		Visual (X-Y)	External (WxHxD)		
Product	678x978		742x1382x536		

**10.559** Graphic Size: 700x1000mm

## DIJON

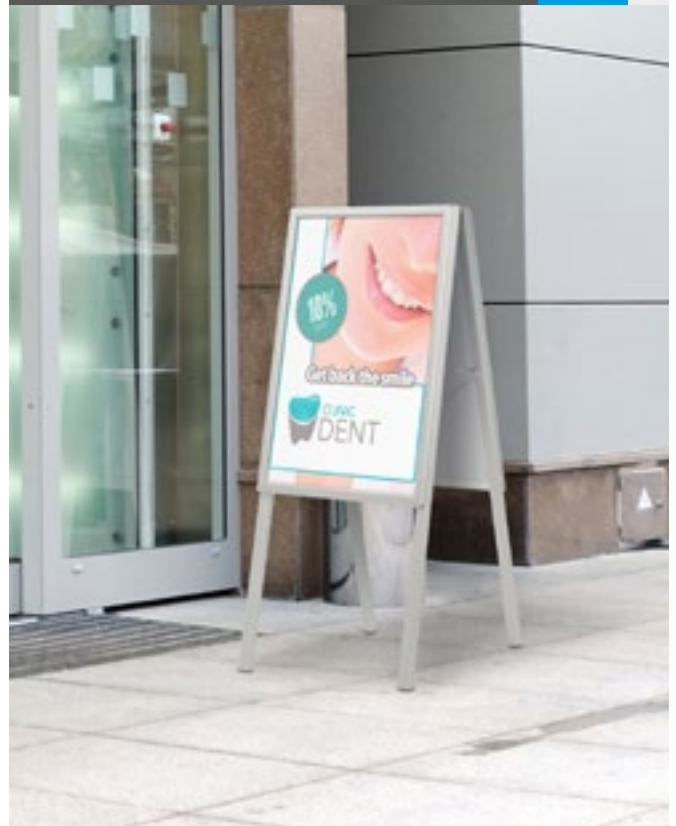

## SIDEWALK DETAILS \* mm GRAPHIC BY CLICK FRAME

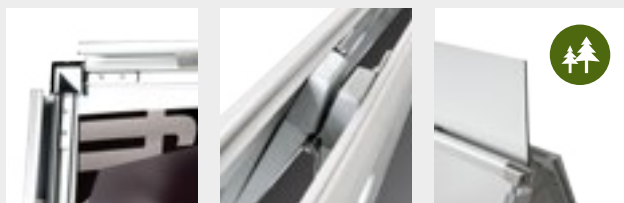

### INFORMATION

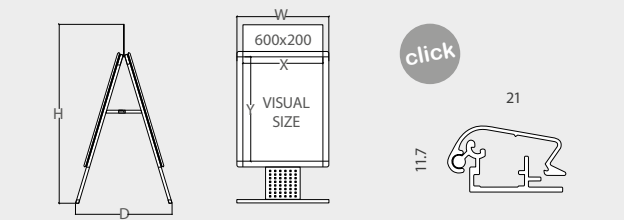

This double-sidewalk is made of aluminum so it is lightweight and resistant to rusting. It has a 21mm width click system profile. It features a headboard support for displaying a graphic. Ideal for outside or inside your store, restaurant, street stall or supermarket. It includes a weather resistant antireflection sheet.

BELMEZ	QTY	N.W	G.W	C.B.M	Size (WxHxD)
Packing	1	13.9kg	15.7kg	0.1085	690x1210x130
		Visual (X-Y)	External (WxHxD)		
Product	581x828		647x1160x625		

**10.235** Graphic Size: A1

## BELMEZ



SIDEWALK DETAILS



DIMENSIONS

\* W: Width H: Height D: Depth \* mm

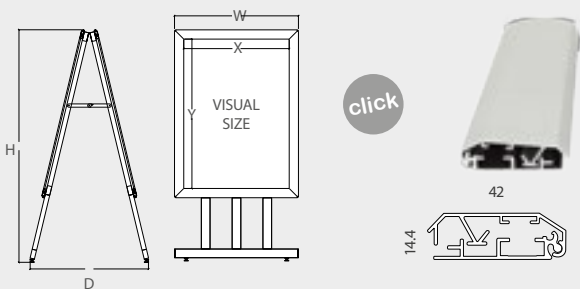

INFORMATION

Montanchez Sidewalk features and structure made of aluminum over a steel structure so this way, its extra weight gives a great stability and it's very resistant to rusting. It has non-slip leveling feet and also a 42mm width profile with click system, so the graphic change is quick and simple. With its double-sided folding frame, Montanchez is designed especially for outdoor use so it's perfect for advertising sales and promotions outside your store. It includes a weather resistant antireflection sheet so is also non-glare which allows it to be read under the bright lights.

H700	QTY	N.W	G.W	C.B.M	Size (WxHxD)
Packing	1	11.95kg	13.1kg	0.070	560x1090x115
		Visual (X-Y)	External (WxHxD)		
Product		480x660	564x1052x524		

10.127 Graphic Size: 500x700mm

H1000	QTY	N.W	G.W	C.B.M	Size (WxHxD)
Packing	1	17.25kg	19.3kg	0.121	880x1375x100
		Visual (X-Y)	External (WxHxD)		
Product		680x960	764x1402x525		

10.128 Graphic Size: 700x1000mm

H1400	QTY	N.W	G.W	C.B.M	Size (WxHxD)
Packing	1	25.5kg	28.5kg	0.1886	1100x1805x98
		Visual (X-Y)	External (WxHxD)		
Product		980x1360	1064x1802x566		

10.129 Graphic Size: 1000x1400mm

MONTANCHEZ



# SIDEWALK BOARDS



Click Boards

## SIDEWALK DETAILS



## SIDEWALK DETAILS

## GRAPHIC BY CLICK FRAME



## DIMENSIONS

\* W: Width H: Height D: Depth \* mm

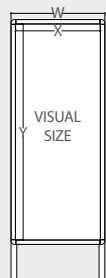
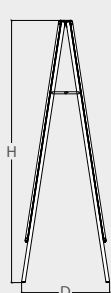

32



20.3

## INFORMATION

The Poznan A-board frame is made of aluminum so it is lightweight and resistant to rusting and it is available on black or silver color. It has a 32mm width profile with click system, so the graphic change is quick and simple. Thanks its double-sided frame and its 1800mm height this A-Board is ideal for advertising large offers, menus, information maps, etc, outside or inside your business. It includes a weather resistant antireflection sheet so is also non-glare which allows it to be read under bright lights.

POZNAN	QTY	N.W	G.W	C.B.M	Size (WxHxD)
Packing	1	12.9kg	14.8kg	0.177	705x1860x135
		Visual (X-Y)	External (WxHxD)		
Product	581x1481		644x1800x600		
10.343		Graphic Size: 600x1500mm			

POZNAN





### SIDEWALK DETAILS



### DIMENSIONS

\* W: Width H: Height D: Depth \* mm

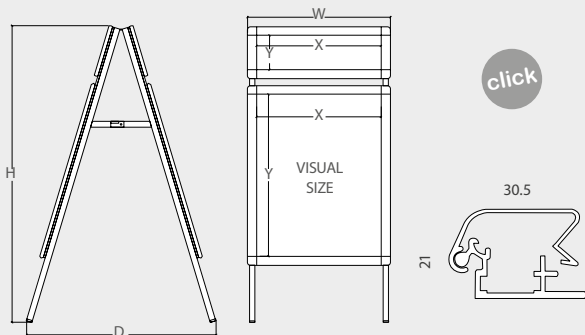

click

### INFORMATION

Toulouse double-Sidewalk is made of aluminum so it is lightweight and resistant. It has a 30.5mm width profile with click system, so the graphic change is quick and simple. Also it includes a resistant antireflection sheet so is also non-glare which allows it to be read under bright lights. Features a headboard support for displaying company logos or graphs. Ideal for displaying sales or promotions at restaurants, stores, shops or supermarkets.

## TOULOUSE



TOULOUSE	QTY	N.W	G.W	C.B.M	Size (WxHxD)
Packing	1	9kg	11kg	0.1010	610x120x1380
	Board Visual (X-Y)	Upper Visual (X-Y)	External (WxHxD)		
Product	485x685	485x185	545x1210x630		
10.806	Board Graphic Size: 500x700mm	Upper Graphic Size: 500x200mm			



## DISPLAY DETAILS

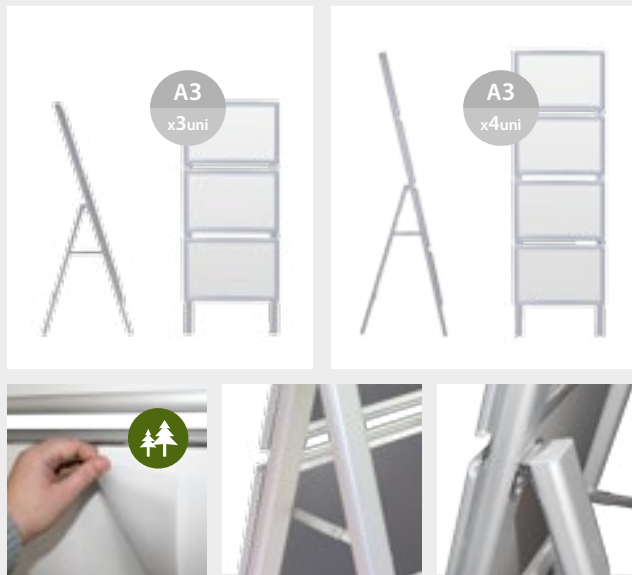

## CLICK FRAME PROFILE DETAILS

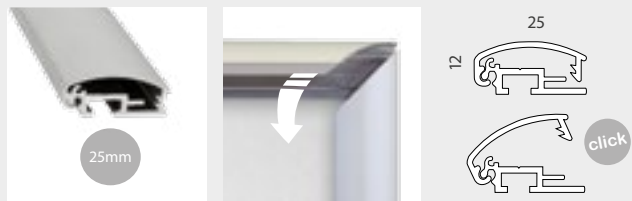

## DIMENSIONS

\* W: Width H: Height D: Depth \* mm

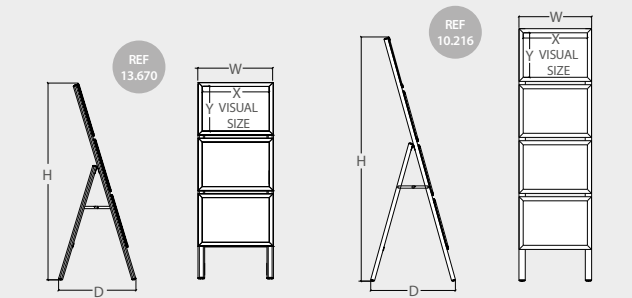

## INFORMATION

This anodized aluminium A-Board is very lightweight, foldable for an easy storage and very resistant to rusting. It features a 25mm width profile with click system, so the graphic change is quick and simple. Also it includes a weather resistant antireflection sheet. The Mota A-Board range features 2 configurations of A3 frames. They are ideal for advertising sales or special promotions inside or outside your business. It's perfect for restaurants, stalls, stores or for any marketplace.

MOTA A3x3	QTY	N.W	G.W	C.B.M	Size (WxHxD)
Packing	1	4.2kg	5.218kg	0.0566	475x1255x95
		Visual (X-Y)	External (WxHxD)		
Product		402x279	455x1182x466		
<b>13.670</b>		<b>Graphic Size: A3 x3</b>			
MOTA A3x4	QTY	N.W	G.W	C.B.M	Size (WxHxD)
Packing	1	5.7kg	6.7kg	0.0722	475x1600x95
		Visual (X-Y)	External (WxHxD)		
Product		402x279	450x1530x490		
<b>10.216</b>		<b>Graphic Size: A3 x4</b>			



## MOTA SINGLE-SIDED





**NEW**



## SIDEWALK DETAILS

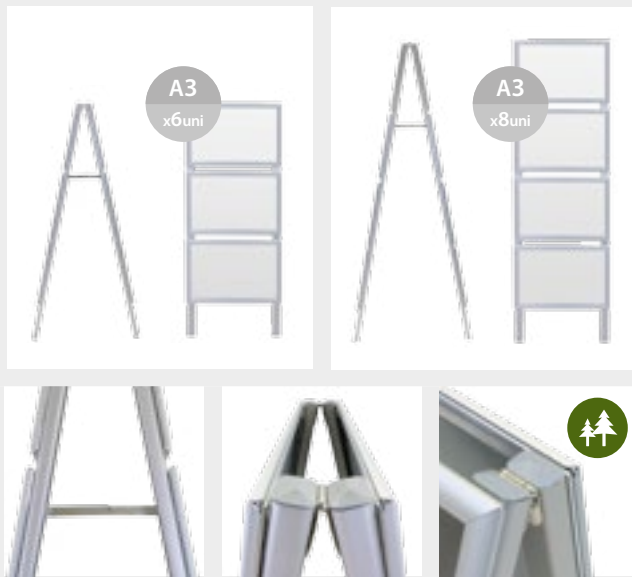

## CLICK FRAME PROFILE DETAILS

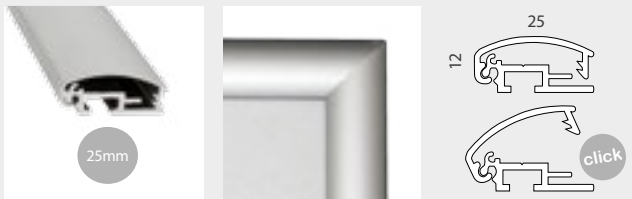

## DIMENSIONS

\* W: Width H: Height D: Depth \* mm

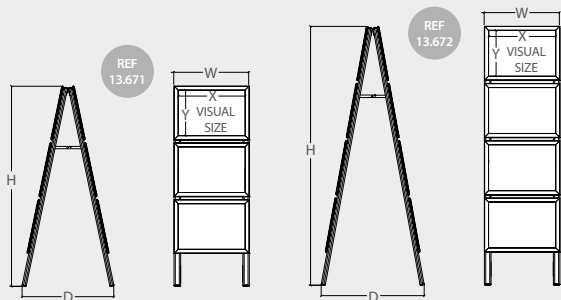

## INFORMATION

This anodized aluminium A-Board is very lightweight, foldable for an easy storage and very resistant to rusting. It features a 25mm width profile with click system, so the graphic change is quick and very simple. Also it includes a weather resistant antireflection sheet so is also non-glare which allows it to be read under bright lights. The Mota A-Board range features 2 configurations of A3 frames. They are ideal for advertising sales or special promotions inside or outside your business. It's perfect for restaurants, stalls, stores or for any marketplace.

MOTA A3 3+3	QTY	N.W	G.W	C.B.M	Size (WxHxD)
Packing	1	6.4kg	7.418kg	0.0566	475x1255x95
		Visual (X-Y)		External (WxHxD)	
Product		402x279	455x1207x553		
<b>13.671</b>		<b>Graphic Size: A3 3+3</b>			
MOTA A3 4+4	QTY	N.W	G.W	C.B.M	Size (WxHxD)
Packing	1	8.3kg	9.559kg	0.0722	475x1600x95
		Visual (X-Y)		External (WxHxD)	
Product		402x279	455x1557x619		
<b>13.672</b>		<b>Graphic Size: A3 4+4</b>			

MOTA  
DOUBLE-SIDED



SIDEWALK DETAILS



with  
rechargeable  
battery



DIMENSIONS

\* W: Width H: Height D: Depth \* mm

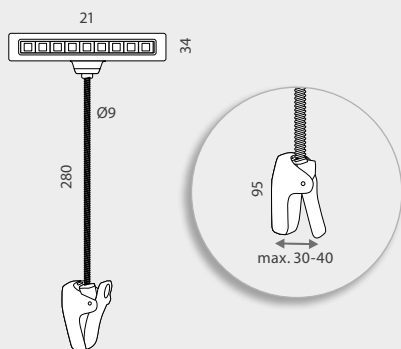

INFORMATION

The Portable and rechargeable 1.8W LED Lamp is a very useful accessory for any display, has an autonomy of more than 6 hours and three levels of brightness (featuring a charging indicator display). With a stunning black finish, this portable LED Lamp will add a touch of distinction and functionality to your display. Thanks to its low consumption and its high strength clamp (3-4cm maximum grip) it can be coupled to a wide range of display products, among them Frame Boards, Blackboards, Photocalls, Lecterns or Counters.

SPOTLIGHT	QTY	N.W	G.W	C.B.M	Size (WxHxD)
Packing	1	0.30kg	0.40kg	0.00174	110x227x70
13.642					

PORTABLE  
LED LAMP



14.111  
A-BOARD SPECIAL TOP  
Seen in BLACKBOARDS



13.641  
WOODEN FAST LECTERN  
LECTERNS  
Seen in FRAMES & INFORMATIVE HOLDERS



10.996  
STEEL DISPLAY  
POSTER DISPLAY  
Seen in STAND DISPLAYS

## SIDEWALK DETAILS



## IBAHERNANDO



## DIMENSIONS

\* W: Width H: Height D: Depth \* mm

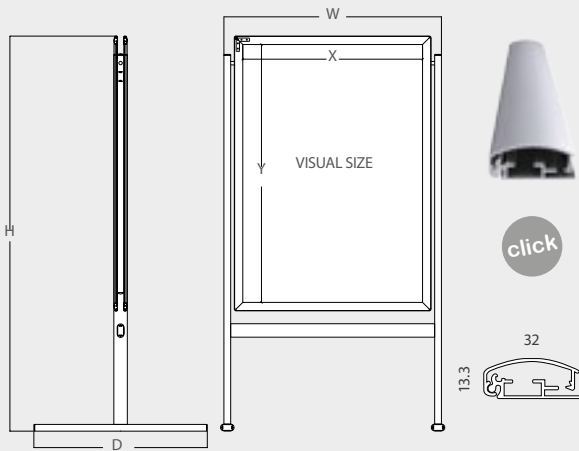

## INFORMATION

The Ibahernando Sidewalk is made of aluminum so it is lightweight and resistant to rusting and wind thanks its strong 847mm length feet. It features a 32mm width profile with click system, so the graphic change is fast and simple y a few seconds. Also it features a revolving board design and it includes a resistant antireflection sheet so is also non-glare which allows it to be read under bright lights. Ibahernando Sidewalk is ideal for displaying sales or promotions at restaurants, stores, shops or at supermarkets.

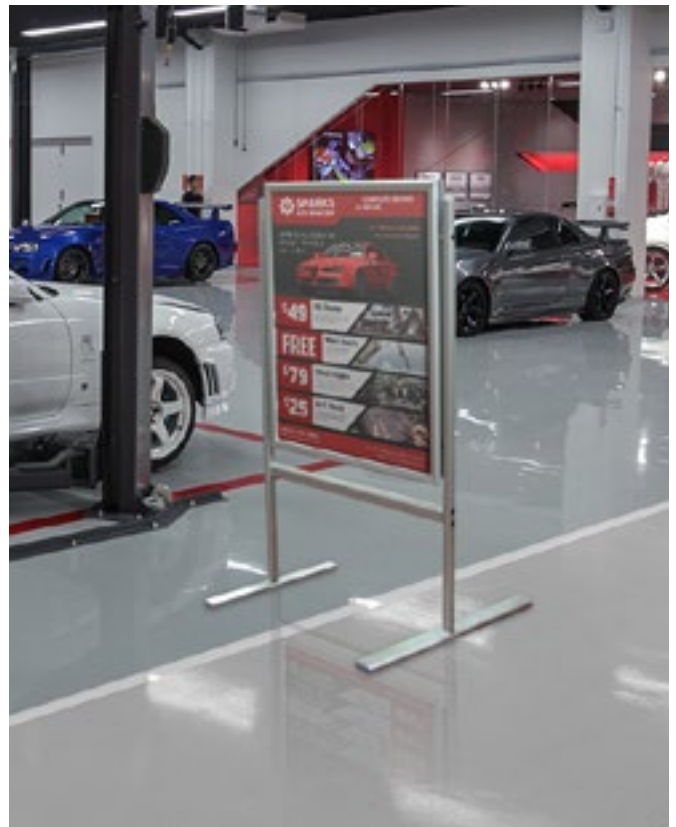

IBAHERNANDO	QTY	N.W	G.W	C.B.M	Size (WxHxD)
Packing	1	9.6kg	11.8kg	0.141	875x1535x105
	Visual (X-Y)	External (WxHxD)			
Product	686x986	821x1506x847			
10.165	Graphic Size: 700x1000mm				



### SIDEWALK DETAILS



### DIMENSIONS

\* W: Width H: Height D: Depth \* mm

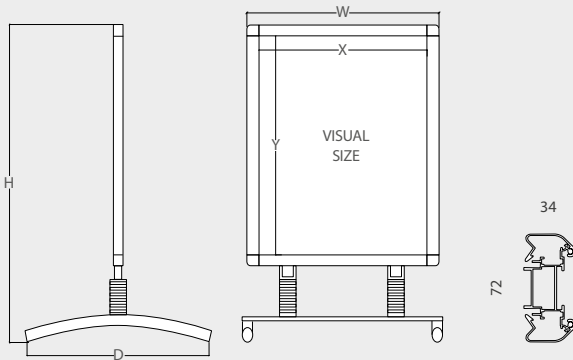

### INFORMATION

Boal Sidewalk is made of aluminum and has a strong base and sturdy springboard design which allows flexion in windy conditions. It has a 34mm width profile with click system, so the graphic change is quick and simple. It includes a resistant antireflection sheet so is also non-glare which allows it to be read under bright lights. Ideal for displaying outside your event, restaurant, street stall or supermarket for advertising offers or temporary exhibitions.

## BOAL



BOAL	QTY	N.W	G.W	C.B.M	Size (WxHxD)	
Packing	1	7.8kg	9.4kg	0.066	750x1100x80	x2
	1	4.55kg	4.85kg	0.009	140x670x100	
		Visual (X-Y)	External (WxHxD)			
Product		570x815	640x1130x560			
10.166		Graphic Size: 605x860mm				



## SIDEWALK DETAILS

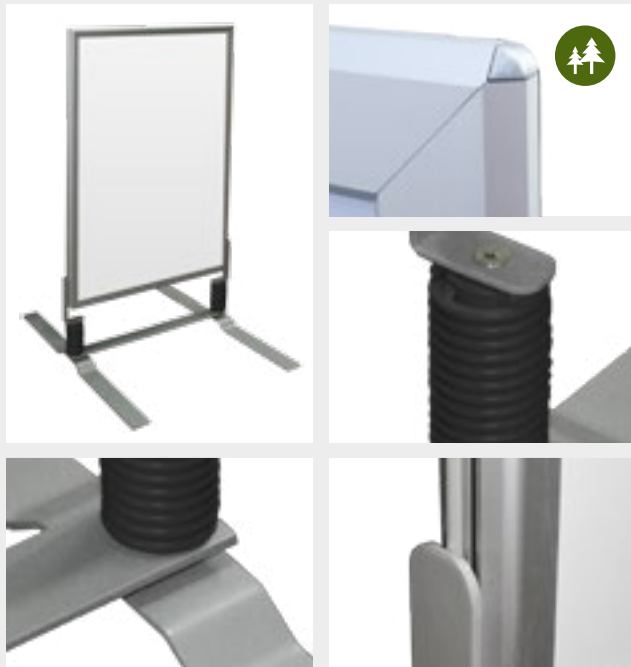

## DIMENSIONS

\* W: Width H: Height D: Depth \* mm

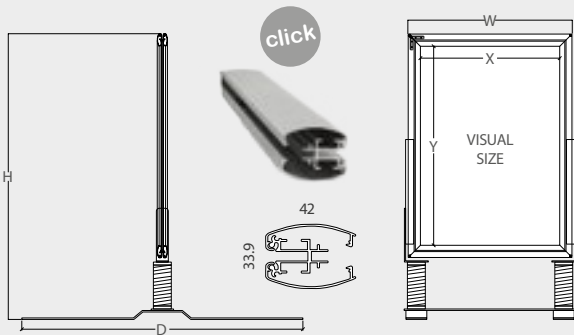

## INFORMATION

Hervas Sidewalk is made of aluminum and has a strong base with a wide footprint and sturdy springboard design which allows the flexion in windy conditions. It has a 42mm width profile with click system, so the graphic change is quick and simple. It includes a resistant antireflection sheet. Ideal for being used inside or outside your gas station, restaurant, street stall or supermarket for advertising last promotions.

HERVAS H700	QTY	N.W	G.W	C.B.M	Size (WxHxD)
Packing	1	4.2kg	5.05kg	0.0373	965x595x65
	1	9.35kg	9.5kg	0.0043	1010x77x55
		Visual (X-Y)	External (WxHxD)		
Product		466x666	575x956x940		



10.161 Graphic Size: 500x700mm

HERVAS H1000	QTY	N.W	G.W	C.B.M	Size (WxHxD)
Packing	1	6.75kg	8.45kg	0.0574	785x1125x65
	1	9.35kg	9.5kg	0.0043	1010x77x55
		Visual (X-Y)	External (WxHxD)		
Product		666x966	750x1256x940		



10.162 Graphic Size: 700x1000mm

## HERVAS



# SIDEWALK BOARDS



Click Refillable Base

## SIDEWALK DETAILS



## DIMENSIONS

## PROFILE \*mm

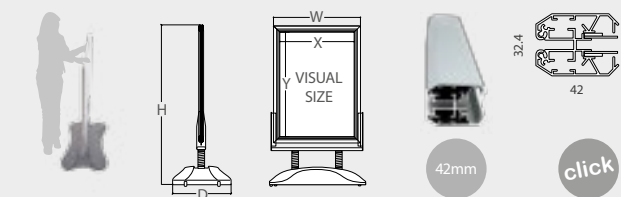

## INFORMATION

This waterproof Click Board is designed especially for outdoor use. The heavy-duty, molded plastic base features a screw-in cap and can be filled with 24l of water for 10.341 and 10.115 models and 52l for 10.116 and 10.342. Also it has a 42mm width waterproof profile with click system, so the graphic change is quick and simple (weather resistant antireflection sheet included). Built-in wheels also make this board easy to move as needed. To further enhance its stability Arcachon features rugged springs to reduce the impact of wind. Ideal for displaying outside the restaurants, street stall, events, supermarkets or fuel stations.

ARCACHON H500	QTY	N.W	G.W	C. B.M	Size (WxHxD)		
Packing	1 Frame	6.75kg	8.1kg	0.0475	660x900x80		
	1 Base	3.7kg	4.4kg	0.068	800x170x500		
		Visual (X-Y)		External (WxHxD)			
Product		478x678	542x1038x510				

10.115			Graphic Size: 500x700mm				
--------	--	--	-------------------------	--	--	--	--

ARCACHON A1	QTY	N.W	G.W	C. B.M	Size (WxHxD)		
Packing	1 Frame	8.1kg	9.2kg	0.0616	740x1040x90		
	1 Base	3.7kg	4.4kg	0.068	800x170x500		
		Visual (X-Y)		External (WxHxD)			
Product		572x819	636x1382x510				

10.341			Graphic Size: A1				
--------	--	--	------------------	--	--	--	--

ARCACHON H700	QTY	N.W	G.W	C. B.M	Size (WxHxD)		
Packing	1 Frame	9.1kg	10.5kg	0.0745	810x1150x80		
	1 Base	5.75kg	6.5kg	0.1085	970x610x180		
		Visual (X-Y)		External (WxHxD)			
Product		678x978	742x1382x510				

10.116			Graphic Size: 700x1000mm				
--------	--	--	--------------------------	--	--	--	--

ARCACHON A0	QTY	N.W	G.W	C. B.M	Size (WxHxD)		
Packing	1 Frame	10.25kg	11.60kg	0.1051	980x1340x80		
	1 Base	5.75kg	6.5kg	0.1085	970x610x180		
		Visual (X-Y)		External (WxHxD)			
Product		833x1182	920x1510x510				

10.342			Graphic Size: A0				
--------	--	--	------------------	--	--	--	--

# ARCACHON



## ANTIREFLECTION SHEET



- EN Antireflection protector sheet for snapframes.
- FR Antireflet pour cadres ou chevalets.
- PT Película antirreflexo para marcos e cavaletes.
- ES Protector antirreflex para marcos y caballetes.

SHEET	SIZE
13.836	534x734mm
13.837	735x1034mm
13.838	628x875mm
13.839	875x1223mm



### SIDEWALK DETAILS

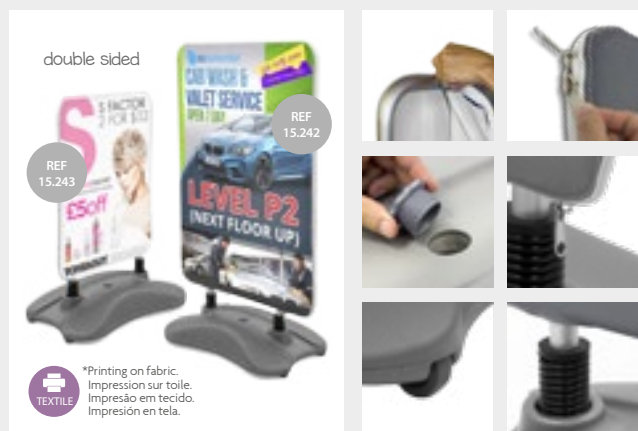

### EXTERNAL SIZES & DOWNLOADABLES ARTWORKS (QR CODE) \*mm

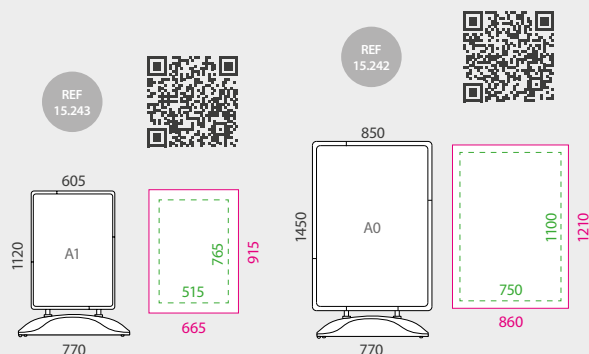

SAFE ZONE  
TOTAL GRAPHIC



SAFE ZONE  
TOTAL GRAPHIC

### INFORMATION

The Mikonos Sidewalk features a lightweight aluminum structure with a refillable plastic base that assembles in seconds (It is 3.95kg weight and it can be filled with 17l of water or sand). Also, the Textile Boards are also simple to setup. All the aluminium poles fit together and snap into base. Simply stretch the wrap over the completed base and it's ready to use. The aluminium structure is affixed to the base with 2 large springs, so it stays stable in windy conditions. Built-in wheels also make this board easy to move as needed. A Nylon Carrying bag is included for an easy storage and transportation. Ideal for denoting your business with the innovative design and versatility of textil printing. TheSidewalk is ideal for being used inside or outside of your restaurant, workshop, street stall, supermarket or heavily-trafficked areas such as tradeshows, events or conventions.

MIKONOS A1	QTY	N.W	G.W	C.B.M	Size (WxHxD)	
Packing	1	75kg	9.5kg	0.11	520x940x230	
15.243	Graphic Size:665x915mm					

MIKONOS A0	QTY	N.W	G.W	C.B.M	Size (WxHxD)	
Packing	1	8kg	10kg	0.11	520x940x230	
15.242	Graphic Size:860x1210mm					

## MIKONOS



\* Custom textil printing in full color is available but not included.

# SIDEWALK BOARDS



Steel Boards

## SIDEWALK DETAILS



## INFORMATION

Kerry 2-sided structure is made of durable lacquered galvanized steel, ensuring years of durability and functionality, available in 3 colors. Designed for indoor and outdoor use. The non-glare protective cover (included) attaches easily using magnets. Ideal to advertise home sales, open houses, restaurant specials, or store sales.

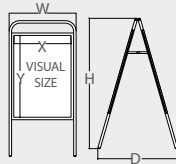

KERRY H700	QTY	N.W	G.W	C.B.M	Size (WxHxD)
Packing	1	11.8kg	12.7kg	0.0504	575x80x1095
		Visual (X-Y)	External (WxHxD)		
Product		462x662	544x1056x647		
10.691	<input type="radio"/>	<input type="radio"/>	<input type="radio"/>	Graphic Size: 500x700mm	

KERRY H1000	QTY	N.W	G.W	C.B.M	Size (WxHxD)
Packing	1	16.35kg	17.9kg	0.0766	760x70x1440
		Visual (X-Y)	External (WxHxD)		
Product		662x962	744x1345x814		
10.692	<input type="radio"/>	<input type="radio"/>	<input type="radio"/>	Graphic Size: 700x1000mm	

# KERRY



## SIDEWALK DETAILS



## INFORMATION

\*mm

Cork 2-sided structure is made of durable lacquered galvanized steel available in 3 colors. Designed for indoor and outdoor use. Also it features a top header area. The non-glare protective cover (included) attaches easily using magnets. Ideal to advertise home sales, open houses, restaurant menu specials or store sales.

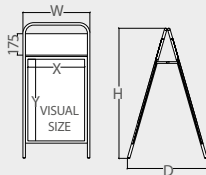

CORK H700	QTY	N.W	G.W	C.B.M	Size (WxHxD)
Packing	1	11.7kg	12.7kg	0.0459	460x70x1170
		Visual (X-Y)	External (WxHxD)		
Product		462x662	544x1056x647		
504x175					
10.695	<input type="radio"/>	<input type="radio"/>	<input type="radio"/>	Graphic Size: 500x700mm Top Header Gr.Size: 175x504mm	

CORK H1000	QTY	N.W	G.W	C.B.M	Size (WxHxD)
Packing	1	18.65kg	20.2kg	0.0766	760x70x1440
		Visual (X-Y)	External (WxHxD)		
Product		662x962	744x1345x814		
704x175					
10.696	<input type="radio"/>	<input type="radio"/>	<input type="radio"/>	Graphic Size: 700x1000mm Top Header Gr. Size: 175x704mm	

# CORK





# SIDEWALK BOARDS Steel Boards

## SIDEWALK DETAILS



## INFORMATION

\*mm

Monaghan 2-sided board is made of durable lacquered galvanized steel available in 3 colors. Designed for indoor and outdoor use. With a top header for a graphic and a non-glare protective cover. Ideal to advertise home sales, open houses, restaurant menu specials or store sales.

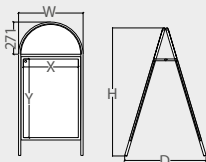

H700	QTY	N.W	G.W	C.B.M	Size (WxHxD)
Packing	1	11.7kg	12.7kg	0.0459	560x70x1170
		Visual (X-Y)	Visual Top (X-Y)		External (WxHxD)
Product		462x662	502x250		683x1078x683
10.699	<input type="radio"/>	<input checked="" type="radio"/>	<input type="radio"/>	Graphic Size: 500x700mm Top Header Gr. Size: 514x256mm	

H1000	QTY	N.W	G.W	C.B.M	Size (WxHxD)
Packing	1	7.5kg	8.9kg	0.0702	765x60x1530
		Visual (X-Y)	Visual Top (X-Y)		External (WxHxD)
Product		702x1002	702x361		742x1523x675
10.700	<input type="radio"/>	<input checked="" type="radio"/>	<input type="radio"/>	Graphic Size: 700x1000mm Top Header Gr. Size: 714x357mm	

## MONAGHAN



## SIDEWALK DETAILS



## DIMENSIONS - LIFFORD JOINING USE

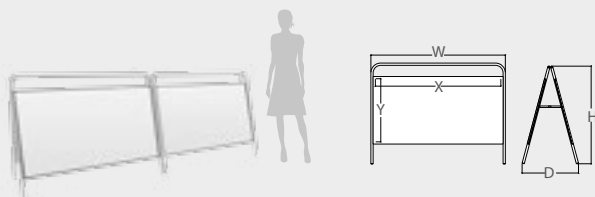

## INFORMATION

Lifford 2-sided board is made of durable white lacquered galvanized steel. Designed for both indoor and outdoor. With non-glare protective cover included which attaches easily to the front using magnets. Ideal to use together with other(s) Lifford for creating a large billboard (see upper example).

LIFFORD	QTY	N.W	G.W	C.B.M	Size (WxHxD)
Packing	1	15.7kg	17kg	0.0751	935x65x1235
		Visual (X-Y)	External (WxHxD)		
Product		1120x564	1200x872x505		
10.701	<input type="radio"/>	Graphic Size: 1156x600mm			

## LIFFORD



\*10.701 Lifford Board at this page is sold by units, the image represented is just one example of its joint use.

## SIDEWALK DETAILS



## DIMENSIONS

\*mm

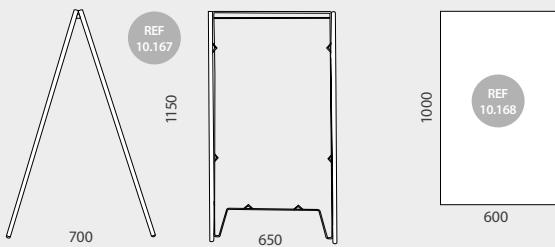

## INFORMATION

The Steel A-board is made of durable Epoxi painted Steel. Featuring 6 colors available and the possibility of being used with a white board panel which is sold separately (10.168). Ideal to advertise home sales, open houses, restaurant specials, store sales or promotional services. To change out signs, just slide the poster through the steel holders.

STEEL A-BOARD	QTY	N.W	G.W	C.B.M	Size (WxHxD)
Packing	1	6kg	6.7kg	0.0523	1200x65x670
	Visual (X-Y)				External (WxHxD)
Product	600x1000				650x1150x700
10.167					
WHITEBOARD P.	QTY	N.W	G.W	C.B.M	Size (WxHxD)
Packing	1	1kg	1kg	0.0523	1200x65x670
10.168		Total Size: 600x1000mm			

## STEEL A-BOARD

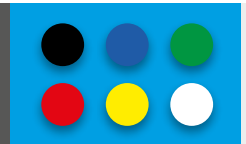

# SIDEWALK BOARDS A-Board

## SIDEWALK DETAILS



### INFORMATION

\* W: Width H: Height D: Depth \* mm

The double-sided Dover A-Board features 3 different models, the first one comes with handle for an easy transportation, second one features all along customizable front for a great visual impact and the third model features a Blackboard in front of both sides.

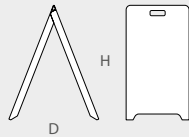

DOVER	QTY	N.W	G.W	C.B.M	Size (WxHxD)
Packing	1	1.4kg	2kg	0.0258	525x55x895
	Visual (X-Y)	13.129	Visual (X-Y)	13.130 13.131	External (WxHxD)
Product	480x715		480x815		500x820x665
13.129	Graphic Size: 480x715mm				
13.130	Graphic Size: 480x815mm				
13.131	Blackboard: 480x815mm				

## DOVER



## STAND DETAILS





### INFORMATION

### DIMENSIONS

\*mm

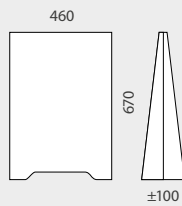
The Neiva stand A-Board has a white finish so it is ideal for customizing with your own offers or graphics. Inexpensive, durable and lightweight, making it easy to relocate as often as needed and also it's assembled in seconds. Neiva is perfect as Eye-catching advertisement for products promotion at point of sale, malls, retail stores, shopping markets.



NEIVA	QTY	N.W	G.W	C.B.M	Size (WxHxD)
Packing	2	1.74kg	2.74kg	0.0569	1055x980x55mm
13.748	460x100x670mm		x2 		

## NEIVA



# SIDEWALK BOARDS Frame Base

## SIDEWALK DETAILS



## DIMENSIONS

## ARTWORK \*mm

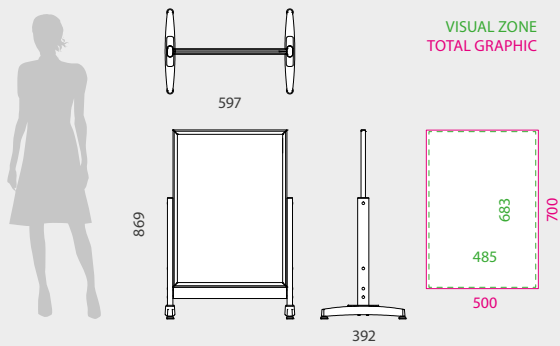

## INFORMATION

Aluminium Board Display is lacquered in gray RAL 9006 and features an easy to load and upload system. With adjustable stability sturdy feet and an easy glide for the 700mm height graphic poster (9mm max.thickness) into the metal grooves of the structure and display it back-to-back. Ideal for promoting at trade shows, outside your office or showroom.

A. BOARD D.	QTY	N.W	G.W	C.B.M	SIZE
Packing	1	3.29kg	4.48kg	0.0436	880x660x75mm
13.598	Graphic Size: 500x700mm				

## ALUMINIUM BOARD FRAME BASE



# SIDEWALK BOARDS A-Board

## SIDEWALK DETAILS



### DIMENSIONS

### ARTWORK

\*mm

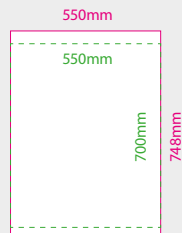
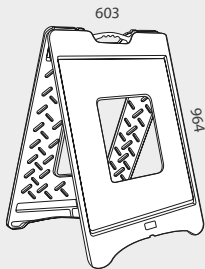

VISUAL ZONE: 550x700mm  
TOTAL GRAPHIC: 550x748mm

### INFORMATION

This sidewalk double sided board is built with long-lasting plastic to resist rust and other weather-related damage. Able to fit 550x748mm posters (5mm maximum thick). Fast and simple change of graphic thanks its top insert slots. Delta is lightweight and it folds down quickly for carrying and an easy storage. The non-slip feet keep them steady on both pavement and bumpy grass. It is perfect for any high-traffic area.

DELTA	QTY	N.W	G.W	C.B.M	SIZE
Packing	1	7kg	8kg	0.05	630x80x1010mm
10.679	Graphic Size: 550x748mm				

## DELTA



SIDEWALK DETAILS



OCEAN



TRANSPORT INSTRUCTIONS



- 1 First, use the foot to tilt the board slightly toward to you.
- 2 Then, move the Ocean Display behind you using its wheels.

INFORMATION

DIMENSIONS \*mm

Resting on a plastic 10l water-refillable base, Ocean outdoor unit is designed for indoor and outdoor use. With an oscillating 620x1000mm board, the advertising options are numerous for your business outdoor sign. Each board is double-sided for twice the promotion. When you need to move the unit, the built-in wheels let you easily reposition to a better location or bring it inside at the end of the work day.

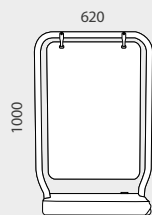

OCEAN	QTY	N.W	G.W	C.B.M	SIZE
Packing	1	5.4kg	7.0kg	0.17	1100x140x1100mm
10.305	Graphic Size: 500x750mm				

# BOARDS & SHOWCASES

# 02

Complete range of blackboards and easels which provide an integral solution for the signage exhibition at selling point areas.

- 82** EASEL BLACKBOARDS
- 83** STANDING BLACKBOARDS
- 90** HANGING BLACKBOARDS
- 93** TABLETOP BLACKBOARDS
- 96** TABLETOP EASELS
- 98** EASEL STANDS
- 99** BOARDS
- 101** ACCESSORIES
- 102** SHOWCASES

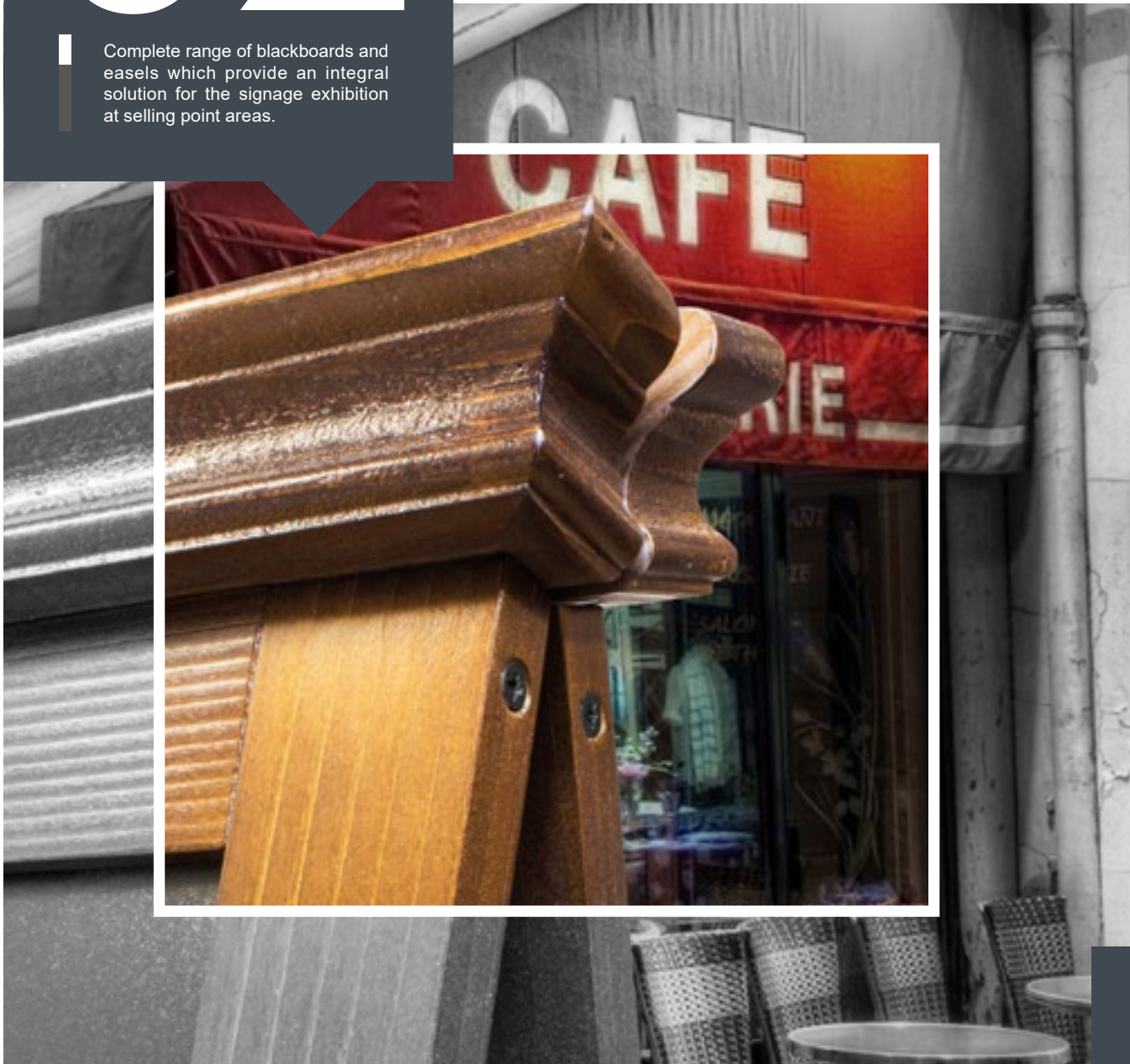

## BLACKBOARD DETAILS



### INFORMATION

This wooden one-sided A-Board is made of light wood, its neutral color allows the chalkboard to blend in virtually to any indoor locations. Featuring a folding rear leg for an easy storage and transportation. These Blackboards are ideal for being used at retail shops, bars, restaurants or for schools.

### DIMENSIONS

\* mm

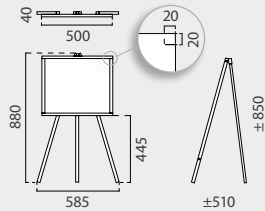

1S EASEL	QTY	N.W	G.W	C.B.M	SIZE
Packing	1	4.5kg	5.5kg	0.0324	600x60x900mm
14.113	Fold: 585x880x40mm		Frame: 20mm		

## ONE-SIDED EASEL



## BLACKBOARD DETAILS



### INFORMATION

A-Board made of light wood with interchangeable and removable boards for a more comfortable graphic change. You can insert 2.5mm advertising on both sides, which helps to draw more potential customer coming from both directions into your business. Ideal for displaying at retail shops, bars, restaurants or schools.

### DIMENSIONS

\* mm

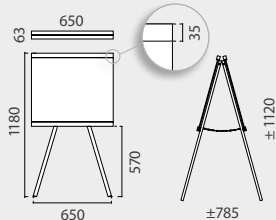

2S EASEL	QTY	N.W	G.W	C.B.M	SIZE
Packing	1	4kg	4.5kg	0.064	670x80x1200mm
14.114	Fold: 650x1180x63mm		Frame: 35mm		

## DOUBLE-SIDED EASEL WITH REMOVABLE BOARDS





# STANDING BLACKBOARDS Blackboards

## BLACKBOARD DETAILS

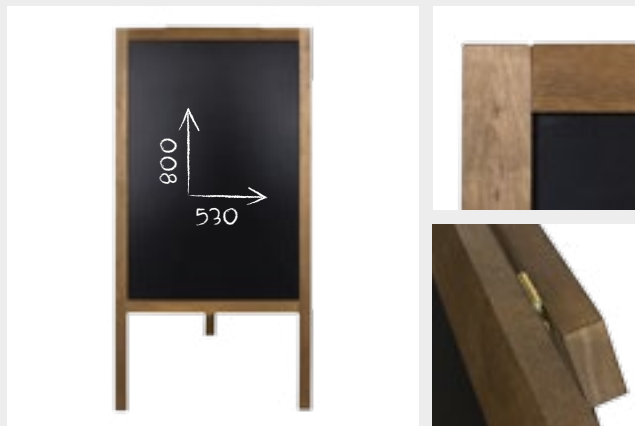

### INFORMATION

Single sided A-Board made of wood with High Density Fiberboard blackboard and natural wooden color which allows it to blend in virtually to any indoor locations. Easy storage and transportation thanks to its folding rear leg. These Blackboards are ideal for being used at retail shops, bars, at restaurants or for the schools.

### DIMENSIONS

\* mm

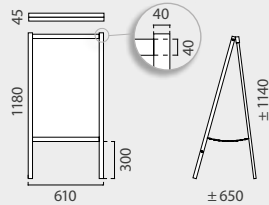

1S BOARD	QTY	N.W	G.W	C.B.M	SIZE
Packing	1	6kg	6.5kg	0.04	620x55x1200mm
14.112	Fold: 610x1180x45mm		Frame: 40mm		

## ONE-SIDED 61x118cm BLACKBOARD



## BLACKBOARD DETAILS

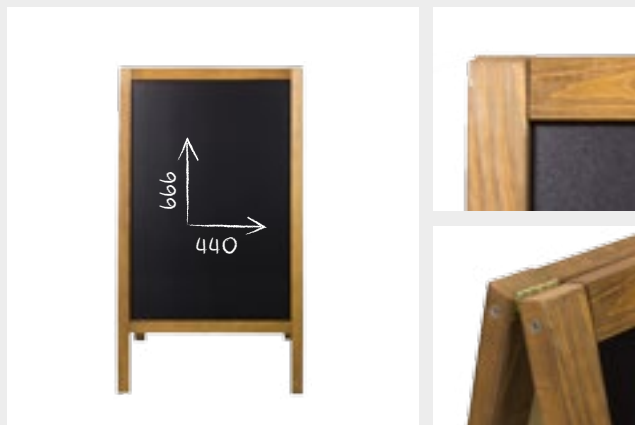

### INFORMATION

Stained and lacquered double-sided A-Board made of wood with High Density Fiberboard. The double-sided signs help to draw more potential customer coming from both directions into your business. Ideal for displaying at retail shops, bars, restaurants or for schools. Perfect to advertise multiple promotions at once.

### DIMENSIONS

\* mm

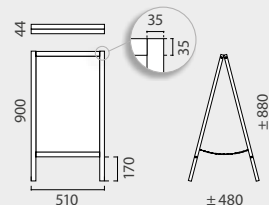

2S 90 BOARD	QTY	N.W	G.W	C.B.M	SIZE
Packing	1	3.1kg	4kg	0.03	520x55x920mm
14.103	Fold: 510x900x44mm		Frame: 35mm		

## DOUBLE-SIDED 51x90cm BLACKBOARD



## BLACKBOARD DETAILS

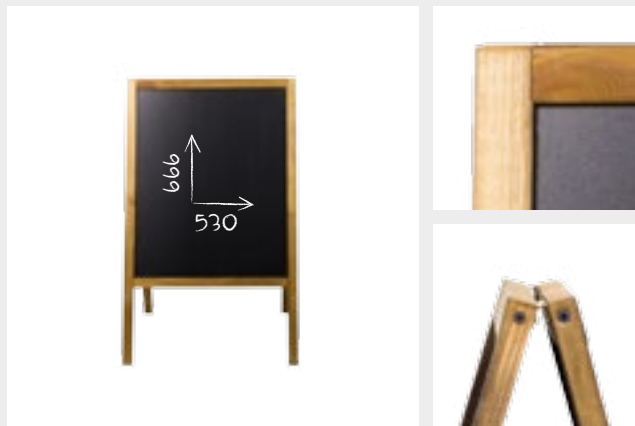

### INFORMATION

Stained and lacquered wooden double-sided "A" Shaped Board. Made of wood with High Density Fiberboard. The double-sided signs help to draw more potential customer coming from both directions into your business. Ideal for displaying at retail shops, bars, restaurants or for the schools.

### DIMENSIONS

\* mm

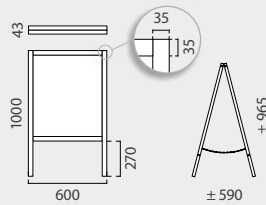

25 100 BOARD	QTY	N.W	G.W	C.B.M	SIZE
Packing	1	4.5kg	5.5kg	0.034	610x55x1020mm
14.104	Fold: 600x1000x43mm		Frame: 35mm		

## DOUBLE-SIDED 60x100cm BLACKBOARD



## BLACKBOARD DETAILS



### INFORMATION

Stained and lacquered wooden double-sided "A" Shaped Board. Made of wood with High Density Fiberboard. The double-sided signs help to draw more potential customer coming from both directions into your business. Ideal for displaying at retail shops, bars, restaurants or for the schools.

### DIMENSIONS

\* mm

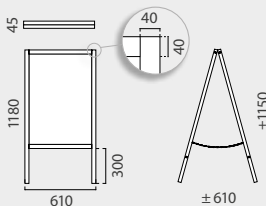

25 118 BOARD	QTY	N.W	G.W	C.B.M	SIZE
Packing	1	6kg	7kg	0.04	615x55x1200mm
14.105	Fold: 610x1180x45mm		Frame: 40mm		

## DOUBLE-SIDED 61x118cm BLACKBOARD



## BLACKBOARD DETAILS

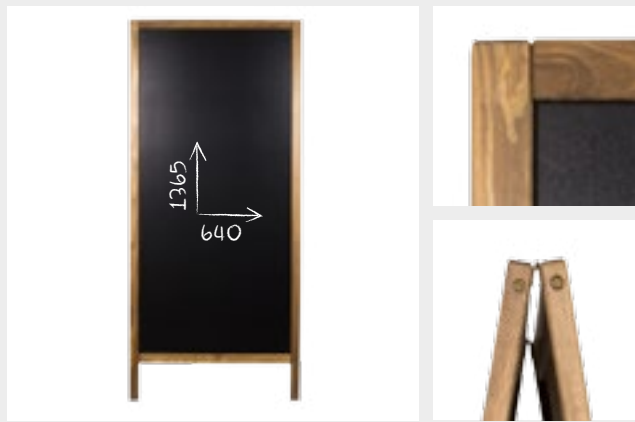

### INFORMATION

Wooden double-sided A-Board with High Density Fiberboard blackboard and natural wooden color which allows it to blend in virtually to any indoor locations. Featuring the larger blackboard available in this catalogue. Foldable for easy storage and mobility. Ideal for being used at retail shops, bars, restaurants or for the schools.

### DIMENSIONS

\* mm

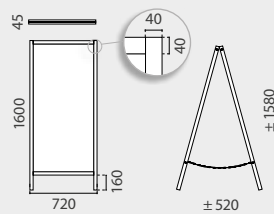

25 XL BOARD	QTY	N.W	G.W	C.B.M	SIZE
Packing	1	8kg	10kg	0.064	725x50x1625mm
14.107	Fold: 720x1600x45mm		Frame: 40mm		

## DOUBLE-SIDED 72x160cm XL BLACKBOARD



## BLACKBOARD DETAILS



### INFORMATION

Stained and lacquered foldable wooden 2-sided A-Board with extended top for advertising space. Made of wood with High Density Fiberboard. The top part of the frame can be engraved on request, please contact us. The double-sided signs help to draw more potential customer coming from both directions to your business.

### DIMENSIONS

\* mm

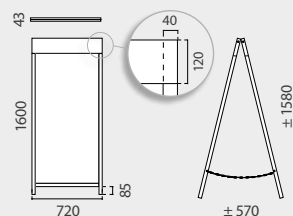

25 LOGO BOARD	QTY	N.W	G.W	C.B.M	SIZE
Packing	1	6kg	7kg	0.071	740x60x1620mm
14.120	Fold: 720x1600x43mm		Top: 720x120mm		

## DOUBLE-SIDED 72x160cm LOGO BLACKBOARD



\* the pyrography at the top of ref. 14.120 is just a suggestion and it is not included.

## BLACKBOARD DETAILS

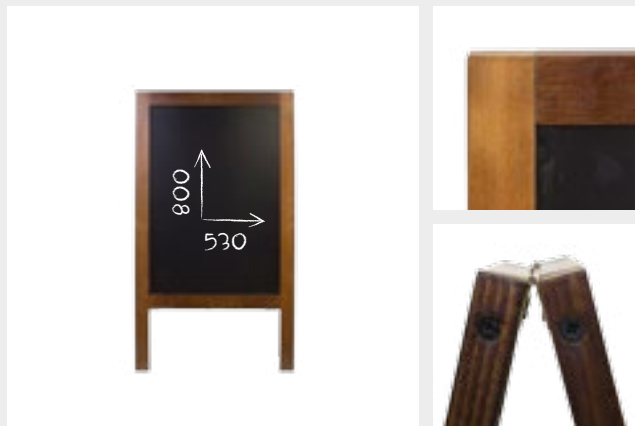

### INFORMATION

This stained and lacquered double-sided "A" Shaped Board is made of wood with High Density Fiberboard. Foldable. The double-sided signs help to draw more potential customer coming from both directions into your business. Ideal for displaying at retail shops, bars, restaurants or for schools.

### DIMENSIONS

\* mm

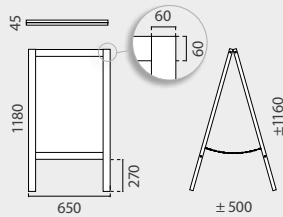

25 118 BOARD	QTY	N.W	G.W	C.B.M	SIZE
Packing	1	6kg	7kg	0.039	660x55x1200mm
14.110	Fold: 650x1180x45mm		Frame: 60mm		

## DOUBLE-SIDED 65x118cm BLACKBOARD



## BLACKBOARD DETAILS



### INFORMATION

Stained and lacquered wooden stylish Blackboard. Made of wood with High Density Fiberboard. Foldable. The double-sided signs help to draw more potential customer coming from both directions into your business. Ideal for displaying in places where a distinctive touch is sought, such as restaurants or academies.

### DIMENSIONS

\* mm

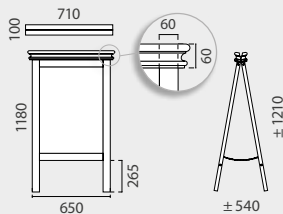

25 TOP BOARD	QTY	N.W	G.W	C.B.M	SIZE
Packing	1	6kg	7kg	0.1	670x120x1250mm
14.111	Fold: 710x1180x100mm		Frame: 60mm		

## DOUBLE-SIDED 65x118cm SPECIAL TOP BLACKBOARD



# STANDING BLACKBOARDS Blackboards

## BLACKBOARD DETAILS

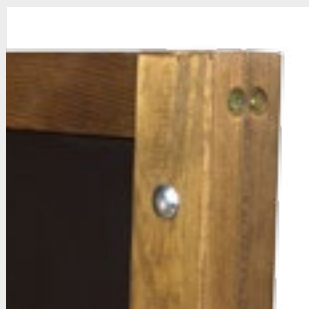
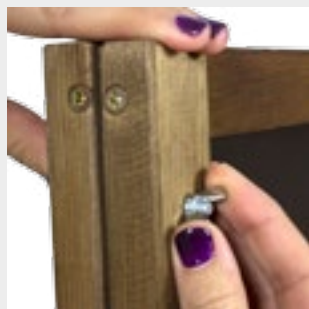
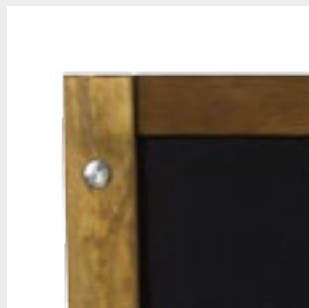

## DIMENSIONS

\* mm

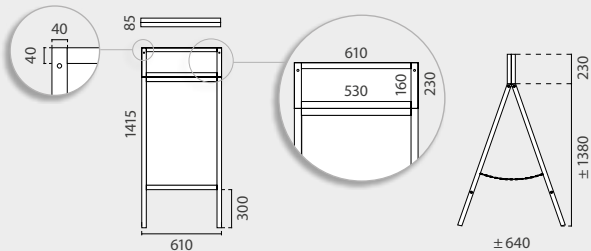

## INFORMATION

This double-sided A-Board is made of wood with High Density Fiberboard blackboard. Its natural wooden color allows the chalkboard to blend in virtually to any indoor locations. Featuring a space header for advert. Foldable for easy storage and mobility. These Blackboards are ideal for being used at retail shops, bars, restaurants or for schools. To write on this a-frame blackboard, users are recommended to use regular stick chalks (not included).

## DOUBLE-SIDED 61x141cm TOP HEADER BLACKBOARD



25 HEADER BOARD	QTY	N.W	G.W	C.B.M	SIZE
Packing	1	7kg	8.5kg	0.12	630x160x1200mm
14.118		Fold: 610x1180x85mm			Frame: 40mm

# STANDING BLACKBOARDS Blackboards

## BLACKBOARD DETAILS

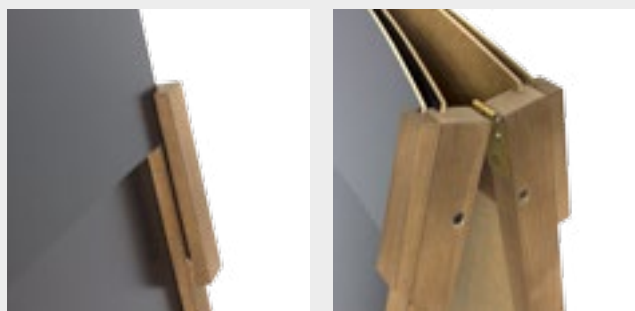
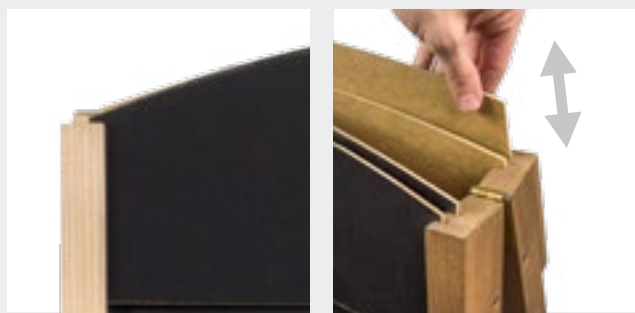
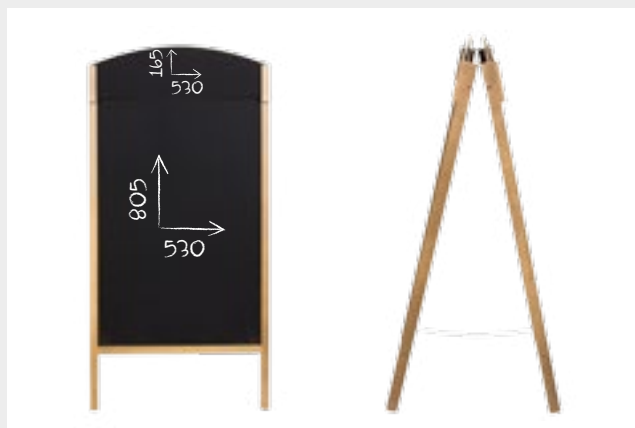

## DIMENSIONS

\* mm

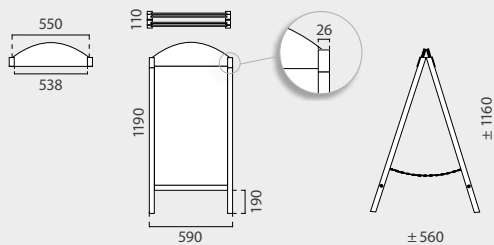

## INFORMATION

This 2-sided A-Board has interchangeable plates for adverts (3mm thickness) and it is made of stained and lacquered wood with High Density Fiberboard. The double-sided signs help to draw more potential customer coming from both directions into your business. Ideal for displaying at retail shops, bars, restaurants or for schools. Foldable for easy storage and mobility. To write on this a-frame black board, users are recommended to use regular stick chalks (not included).

25 CHANGE	QTY	N.W	G.W	C.B.M	SIZE
Packing	1	6kg	7kg	0.0991	610x130x1250mm
14.119		Fold: 590x1190x110mm		Top: 165x530mm	

## DOUBLE-SIDED 59x119cm INTERCHANGEABLE TOP BOARD



## BLACKBOARD DETAILS



### INFORMATION

Stained and lacquered waterproof double-sided "A" Shaped Board. It features an ABS blackboard. It is protected against harmful weather conditions. The double-sided signs help to draw more potential customer coming from both directions into your business. Ideal for displaying at retail shops, bars, restaurants or for the schools. Foldable for an easy storage.

### DIMENSIONS

\* mm

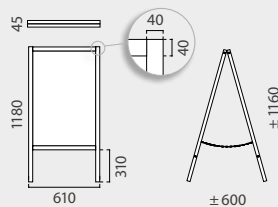

WATERPROOF	QTY	N.W	G.W	C.B.M	SIZE
Packing	1	6kg	7kg	0.037	620x50x1200mm
14.106	Fold: 610x1180x45mm		Frame: 40mm		

## DOUBLE-SIDED 61x118cm WATERPROOF BLACKBOARD



## BLACKBOARD DETAILS



### INFORMATION

This stained and lacquered wooden double-sided Board is made of natural logs. The double-sided signs help to draw more potential customer coming from both directions into your business. Ideal for displaying at retail shops, bars, restaurants or for schools. Foldable for an easy storage and to facilitate mobility.

### DIMENSIONS

\* mm

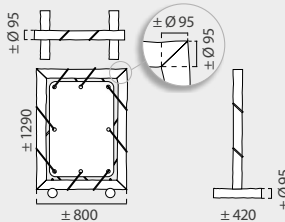

WOODEN LOGS	QTY	N.W	G.W	C.B.M	SIZE
Packing	1	13kg	14.5kg	0,1428	850x120x1400mm
14.116	Fold: 800x1290x95mm		± 095mm		

## DOUBLE-SIDED 80x129cm WOOD LOGS BLACKBOARD





### BLACKBOARDS DETAILS

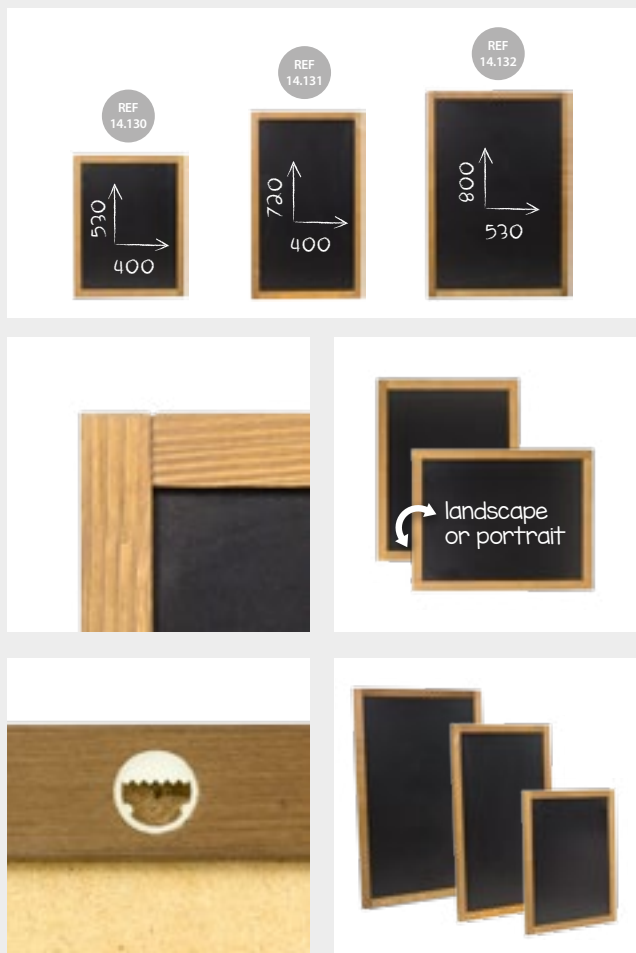

### DIMENSIONS

\* mm

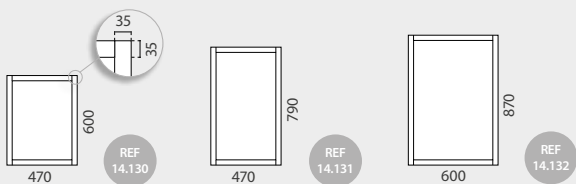

### INFORMATION

This hanging frame is made of stained wood with HDF board. All of them have an appropriate hanger system included. With 3 sizes available. Perfect for displaying last company's offers. Ideal for being used at retail shops, bars, restaurants, etc...

REGULAR H. 60	QTY	N.W	G.W	C.B.M	SIZE
Packing	1	1.2kg	2kg	0.009	490x30x620mm
<b>14.130</b>	<b>Outer Size: 470x600x20mm</b>		<b>Frame: 35mm</b>		
REGULAR H. 79	QTY	N.W	G.W	C.B.M	SIZE
Packing	1	1.5kg	2.5kg	0.011	490x30x810mm
<b>14.131</b>	<b>Outer Size: 470x790x20mm</b>		<b>Frame: 35mm</b>		
REGULAR H. 87	QTY	N.W	G.W	C.B.M	SIZE
Packing	1	2kg	3kg	0.016	620x30x890mm
<b>14.132</b>	<b>Outer Size: 600x870x20mm</b>		<b>Frame: 35mm</b>		

### HANGING 3.5cm FRAME CLASIC BLACKBOARD





# HANGING BLACKBOARDS Top Logo Frame

## BLACKBOARDS DETAILS



## DIMENSIONS

\* mm

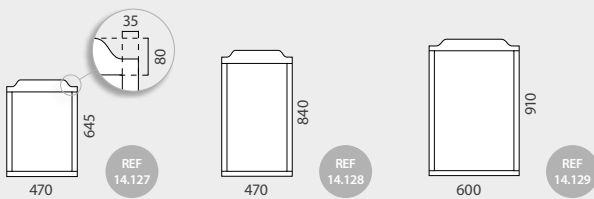

## INFORMATION

This hanging frame features an extended top space. All of them have an appropriate hanger system. Three sizes available. Perfect for displaying last company's offers. Ideal for being used at retail shops, bars, restaurants, etc..

WAVES TOP 64.5	QTY	N.W	G.W	C.B.M	SIZE
Packing	1	1.2kg	2kg	0.009	490x30x660mm
<b>14.127</b>	<b>Outer Size: 470x645x20mm</b>				
WAVES TOP 84	QTY	N.W	G.W	C.B.M	SIZE
Packing	1	1.5kg	2.5kg	0.012	490x30x860mm
<b>14.128</b>	<b>Outer Size: 470x840x20mm</b>				
WAVES TOP 91	QTY	N.W	G.W	C.B.M	SIZE
Packing	1	2kg	3kg	0.017	620x30x930mm
<b>14.129</b>	<b>Outer Size: 600x910x20mm</b>				

## HANGING 3.5cm FRAME TOP LOGO BLACKBOARD



# HANGING BLACKBOARDS Lacquered Stylish Frame

## BLACKBOARDS DETAILS



## DIMENSIONS

\* mm

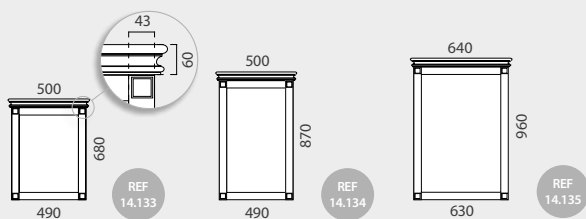

## INFORMATION

This hanging frame is made of lacquered wood and features a stylish decorative cornice embellishment top. All hanging boards have an appropriate hanger system included. 3 sizes available. Ideal for being used at retail shops, bars or restaurants.

LACQUERED H.68	QTY	N.W	G.W	C.B.M	SIZE
Packing	1	1.5kg	2.5kg	0.025	520x70x710mm
<b>14.133</b>	<b>Outer Size: 500x680x47mm</b>				
LACQUERED H. 87	QTY	N.W	G.W	C.B.M	SIZE
Packing	1	2kg	3kg	0.032	520x70x900mm
<b>14.134</b>	<b>Outer Size: 500x870x47mm</b>				
LACQUERED H. 96	QTY	N.W	G.W	C.B.M	SIZE
Packing	1	2.5kg	3.5kg	0.044	650x70x980mm
<b>14.135</b>	<b>Outer Size: 640x960x47mm</b>				

## HANGING 4.3cm LACQUERED FRAME STYLISH BLACKBOARD



# TABLETOP BLACKBOARDS Slanted | Base

## BLACKBOARDS DETAILS



### INFORMATION

### DIMENSIONS

\* mm

These slate displays are made of stained wood and HDF board, and come in A4 or A5 format, so you can choose the appropriate size for your showing.



SLANTED A5	QTY	N.W	G.W	C.B.M	SIZE
------------	-----	-----	-----	-------	------

Packing	1	0.4kg	1kg	0.0039	175x90x250mm
---------	---	-------	-----	--------	--------------

**14.147** Outer Size: 155x230x63mm Base: 155x63x20mm

SLANTED A4	QTY	N.W	G.W	C.B.M	SIZE
------------	-----	-----	-----	-------	------

Packing	1	0.5kg	1kg	0.007	230x90x340mm
---------	---	-------	-----	-------	--------------

**14.148** Outer Size: 210x312x63mm Base: 210x63x20mm

## ONE SIDED TABLETOP SLANTED BLACKBOARD



## BLACKBOARDS DETAILS



### INFORMATION

### DIMENSIONS

\* mm

The Table Boards are made of stained wood and HDF board. Ideal to announce upcoming events, shows, meetings or drinks offers at bars or restaurants.

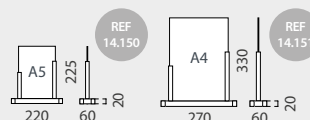

BASE A5	QTY	N.W	G.W	C.B.M	SIZE
---------	-----	-----	-----	-------	------

Packing	1	0.32kg	1kg	0.0044	230x80x240mm
---------	---	--------	-----	--------	--------------

**14.150** Outer Size: 220x225x60mm Base: 220x60x20mm

BASE A4	QTY	N.W	G.W	C.B.M	SIZE
---------	-----	-----	-----	-------	------

Packing	1	0.6kg	1kg	0.0081	350x80x290mm
---------	---	-------	-----	--------	--------------

**14.151** Outer Size: 270x330x60mm Base: 270x60x20mm

## DOUBLE SIDED TABLETOP BASE BLACKBOARD



## BLACKBOARDS DETAILS



### INFORMATION

### DIMENSIONS

\* mm

These double sided HDF A-boards come in A4 or A5 sizes. Ideal to announce upcoming events, shows, meetings or drinks offers at your bar, club or restaurant.

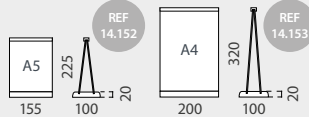

TENT A5	QTY	N.W	G.W	C.B.M	SIZE
---------	-----	-----	-----	-------	------

Packing	1	0.25kg	1kg	0.0052	175x120x250mm
---------	---	--------	-----	--------	---------------

**14.152** Outer Size: 155x225x100mm Base: 155x100x20mm

TENT A4	QTY	N.W	G.W	C.B.M	SIZE
---------	-----	-----	-----	-------	------

Packing	1	0.4kg	1kg	0.0089	220x120x340mm
---------	---	-------	-----	--------	---------------

**14.153** Outer Size: 200x320x100mm Base: 200x100x20mm

## DOUBLE SIDED TABLETOP TENT BLACKBOARD



## BLACKBOARDS DETAILS



### INFORMATION

### DIMENSIONS

\* mm

The double sided HDF A-boards feature a stylish framed design. Ideal to announce upcoming events, shows, meetings or drinks offers at your bar, club or restaurant.

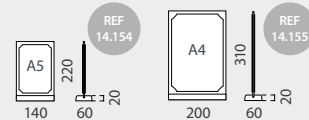

FRAMING A5	QTY	N.W	G.W	C.B.M	SIZE
------------	-----	-----	-----	-------	------

Packing	1	0.3kg	1kg	0.003	160x80x240mm
---------	---	-------	-----	-------	--------------

**14.154** Outer Size: 140x220x60mm Base: 140x60x20mm

FRAMING A4	QTY	N.W	G.W	C.B.M	SIZE
------------	-----	-----	-----	-------	------

Packing	1	0.5kg	1kg	0.0058	220x80x330mm
---------	---	-------	-----	--------	--------------

**14.155** Outer Size: 200x310x60mm Base: 200x60x20mm

## DOUBLE SIDED TABLETOP FRAMING BLACKBOARD



## BLACKBOARD DETAILS

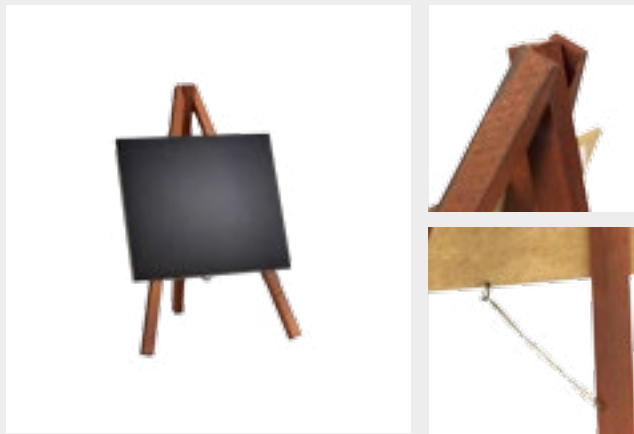

### INFORMATION

This tabletop blackboard is made of stained wood. It includes an adjustable angle back leg and a chain stopper. Perfect for displaying at the academies entrances, on the information desks, at the waiting rooms or at the offices...

### DIMENSIONS

\* mm

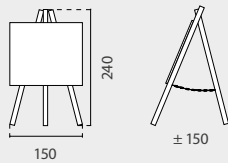

EASEL 24x15	QTY	N.W	G.W	C.B.M	SIZE
Packing	1	0.4kg	1kg	0.017	170x40x260mm
14.149	Fold: 150x240x20mm		Header: 150x130mm		

## ONE SIDED TABLETOP EASEL BLACKBOARD



# TABLETOP EASELS Tabletop Wooden Easels

## EASEL DETAILS



## INFORMATION

## DIMENSIONS

\* mm

The mini wood Easels, rely on their triangular silhouette to provide a solid base for your painting and they fold flat for easy storage. They are ideal for displaying art, photography at meetings, galleries, etc... Perfect to display with a touch of distinction and in small spaces.

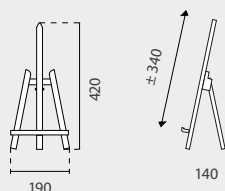

EASEL 42x19-34	QTY	N.W	G.W	C.B.M	SIZE
Packing	1	0.5kg	1kg	0.0073	210x80x440mm
14.141	Folded Size: 190x60x420mm		Strip: 20mm		

## TABLETOP WOODEN EASEL 42x19-34cm



## EASEL DETAILS



## INFORMATION

## DIMENSIONS

\* mm

The mini wood Easels, rely on their triangular silhouette to provide a solid base for your painting and they fold flat for easy storage. It features an adjustable angle back leg. They are ideal for displaying art, photography at meetings, galleries, etc... Perfect to display with a touch of distinction and in small spaces.

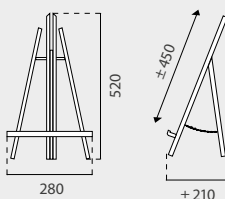

EASEL 52x28-45	QTY	N.W	G.W	C.B.M	SIZE
Packing	1	0.5kg	1kg	0.011	300x70x540mm
14.142	Folded Size: 280x50x520mm		Strip: 20mm		

## TABLETOP WOODEN EASEL 52x28-45cm



# TABLETOP EASELS Tabletop Wooden Easels

## EASEL DETAILS



## INFORMATION

## DIMENSIONS

\* mm

This Easel provides a solid base for your painting and it fold flat for easy storage. It features a canvas height adjustment, so you can accommodate canvas up to 540mm in height. Ideal for displaying art, photography at meetings, galleries, etc... Perfect to display with a touch of distinction and in small spaces.

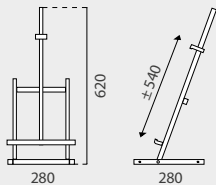

EASEL 62x28-54	QTY	N.W	G.W	C.B.M	SIZE
Packing	1	0.5kg	1kg	0.019	300x100x640mm
14.143	Folded Size: 280x90x700mm		Strip: 20mm		

## TABLETOP WOODEN EASEL 62x28-54cm



## EASEL DETAILS



## INFORMATION

## DIMENSIONS

\* mm

A-Wooden Easel features a triangular silhouette to provide a solid base for your graphic or your paintings. The rear leg allows for placement in corners and tight spaces and can be flattened for easy storage. Ideal as elegantly promotional display, also many business and home owners use it to showcase fine art or photography.

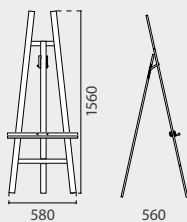

	QTY	N.W	G.W	C.B.M	SIZE
Packing	1	3kg	4kg	0.428	600x420x1700mm
14.140	Folded: 580x110x1560mm		Strip: 40mm		

## WOODEN EASEL 156x60-122cm

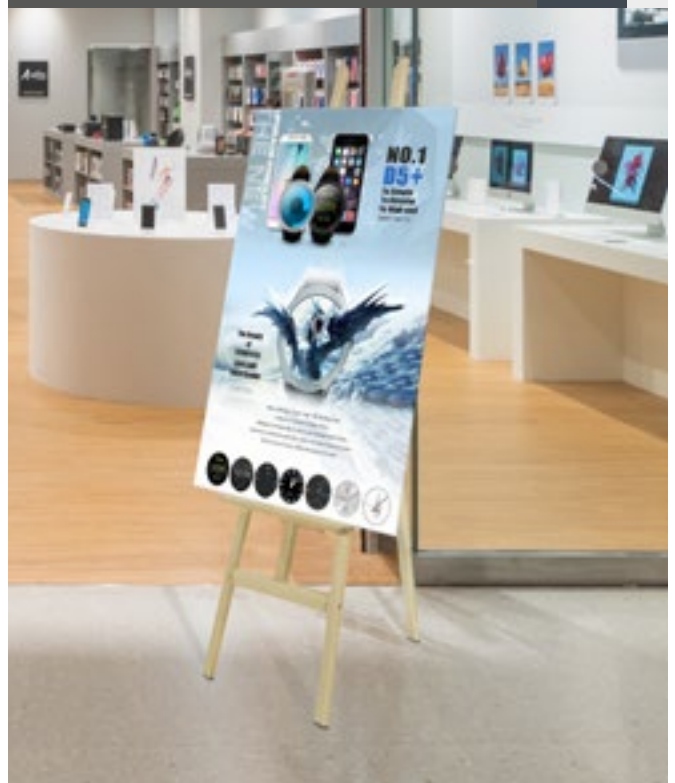

# EASEL STANDS A-Easels

## EASEL DETAILS



### INFORMATION

This classic Wooden Easel features a canvas adjustment up to 1330mm in height. The rear leg allows for placement in corners and tight spaces and also, it can be flattened for easy storage. Ideal as elegantly promotional display, also many business and home owners use it to showcase fine art or photography.

### DIMENSIONS

\* mm

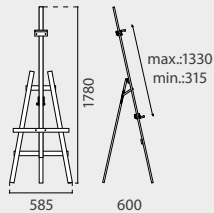

EASEL 178x60-133	QTY	N.W	G.W	C.B.M	SIZE
Packing	1	3kg	4kg	0.504	600x420x2000mm
14.139	Folded: 585x110x1780mm		Strip: 40mm		

## WOODEN EASEL

178x60-133cm



## EASEL DETAILS

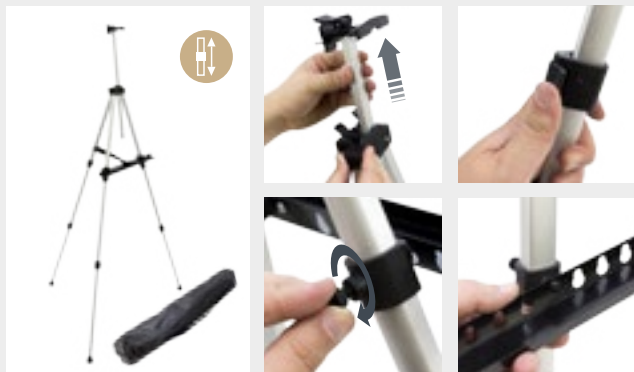

### INFORMATION

Solana is made with an aluminum alloy that is strong and stable, featuring adjustable height, so its telescopic legs can be shortened for table top use or lengthened for a floor standing display. This telescoping aluminum easel is a versatile method to use for any type of showcase. Whether you're travelling for tradeshows or art exhibits, use this silver telescoping easel for a durable, yet convenient tool to display your work.

### DIMENSIONS

\* mm

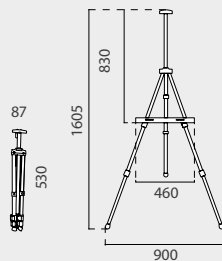

SOLANA	QTY	N.W	G.W	C.B.M	Size
Packing	1	0.65kg	0.75kg	0.0035	80x560x80
10.816	Folded: 87x530x65mm Max. Outer Size: 780x1605x900mm				

## SOLANA EASEL





## BOARD DETAILS



14.031  
14.032  
14.033



magnets available  
(not included)

## INFORMATION

## DIMENSIONS \* W: Width H: Height

This whiteboard features a magnetic surface easy to clean, which is suitable for writing with erasable markers. It is a versatile presentation tool that you can use in various settings to supplement an informative presentation. Ideal for classrooms or conference offices.

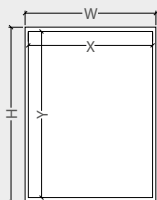

RENNES	EXTERNAL (WxH)	VISUAL (X-Y)	A4 QTY
10.329	502x672mm	487x657mm	4 x A4
14.094	502x992mm	487x977mm	6 x A4
14.095	732x992mm	717x977mm	9 x A4
10.332	962x992mm	947x977mm	12 x A4

## RENNES BOARD



\* Markers at this page are not included

## BOARD DETAILS



pins available (not included)

14.034



## INFORMATION

## DIMENSIONS \* W: Width H: Height

This whiteboard is equipped with a perforated magnetic surface that covers a cork board, so you can hold paper notes with pins or magnets. It is a versatile presentation tool that you can use in various settings to supplement an informative presentation. It is ideal for classrooms or for conference offices.

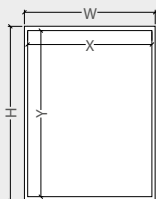

SALLES	EXTERNAL (WxH)	VISUAL (X-Y)	A4 QTY
10.333	502x672mm	487x657mm	4 x A4
10.334	502x992mm	487x977mm	6 x A4
14.096	732x992mm	717x977mm	9 x A4
14.097	962x992mm	947x977mm	12 x A4

## SALLES BOARD



\* Magnets and pins at this page are available but not included

BOARD DETAILS

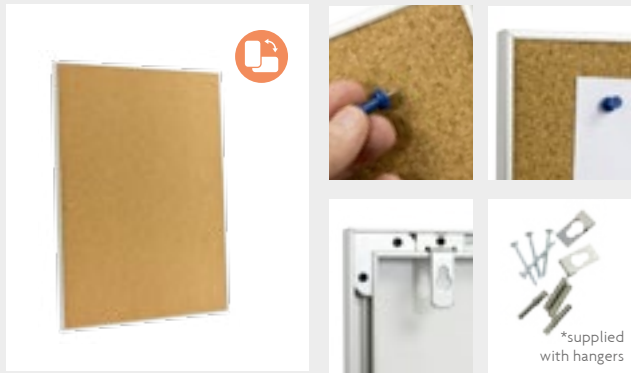

INFORMATION

\* W: Width H: Height

Dax cork board is made of aluminum frame with metallic hangers. It features a self healing, finely ground cork surface that will stand up for years of use. Hangers and screws are included. Ideal for being used at hospitals, schools, for government agencies, conference offices or for common rooms.

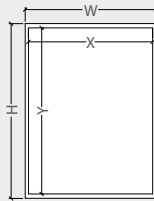

DAX	EXTERNAL (WxH)	VISUAL (X-Y)	A4 QTY
10.320	502x672mm	487x657mm	4 x A4
10.321	502x992mm	487x977mm	6 x A4
10.325	732x992mm	717x977mm	9 x A4
10.328	962x992mm	947x977mm	12 x A4

DAX FRAME BOARD

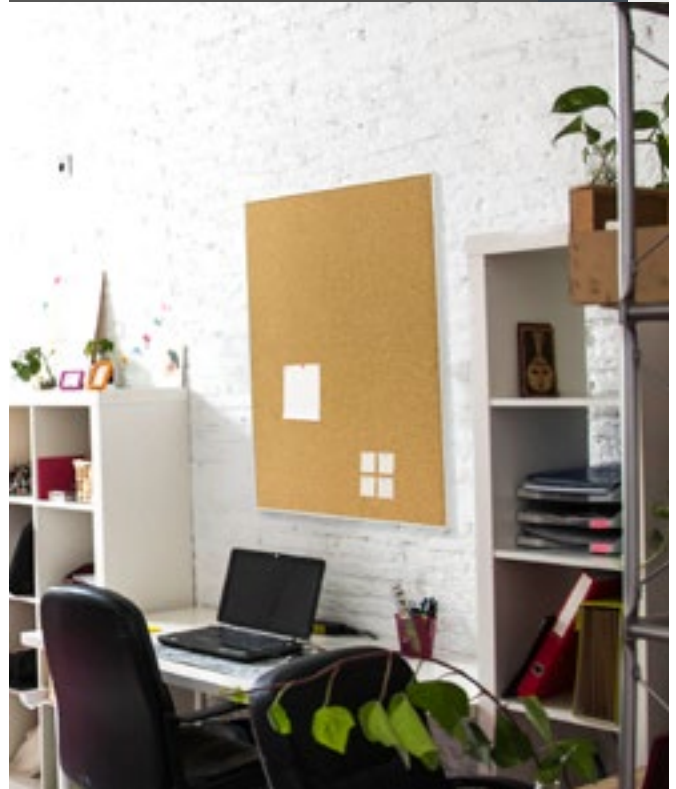

BOARD DETAILS

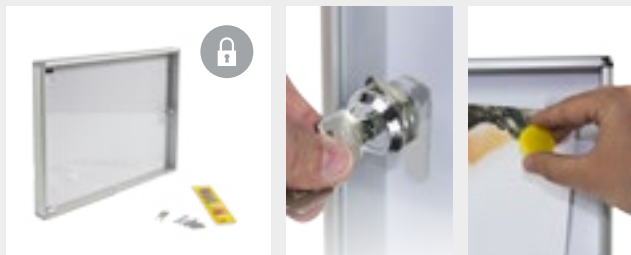

INFORMATION

DIMENSIONS

\* mm

Bulletin Board Box is made of anodized aluminium and designed with a single acrylic lockable door, that provides controlled access to the posting surface, also, it includes magnet accessories (ref. 14.032). A4 or 2xA4 format available. Ideal for signs, announcements, messages, photos or memorabilia. Ideal at community common areas, schools, universities or supermarkets.

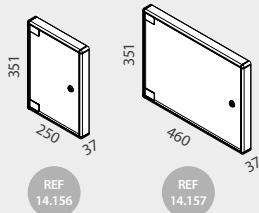

1x A4	QTY	N.W	G.W	C.B.M	SIZE
Packing	1	1.453kg	1.65kg	0.0052	400x280x46 mm
<b>14.156</b>	<b>1xA4</b>	<b>External Size: 250x351x37mm</b>			
2x A4	QTY	N.W	G.W	C.B.M	SIZE
Packing	1	2.427kg	2.679kg	0.0088	506x380x46 mm
<b>14.157</b>	<b>2xA4</b>	<b>External Size: 460x351x37mm</b>			

BULLETIN BOARD BOX  
WATERLOO



\* Magnets and pins at this page are available but not included.

PINS DETAILS



INFORMATION

Metallic pins with plastic colored headers that are suitable for cork boards.

PINS

14.034	100 units
--------	-----------

PINS



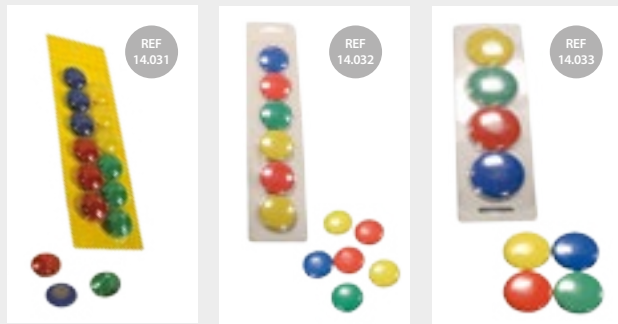

MAGNETS DETAILS



INFORMATION

These colored magnets are suitable for boards with metallic background.

MAGNETS	DIAMETER	
14.031	Ø 20mm	x12 
14.032	Ø 30mm	x6 
14.033	Ø 40mm	x4 

MAGNETS



ERASER DETAILS



INFORMATION

Plastic eraser that is suitable for being used with erasable markers

ERASER

14.030
--------

ERASER



# SHOWCASES Cork Background

## BOARD DETAILS



## INFORMATION

\* W: Width H: Height

This showcase with aluminium frame and acrylic lockable door includes a background made of cork. Featuring rounded corners and a front locker. These bulletin boards exhibit your important information in hallways, classrooms, vestibules, reception rooms or more! The single lockable door ensures that documents, graphics or pictures stay clean and undisturbed.

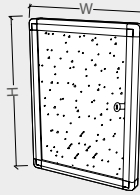

## BAYERN SIZES

BAYERN	SIZES
14.090	250x400mm
14.043	350x500mm
14.044	500x700mm
14.091	600x600mm

## BAYERN



## BOARD DETAILS



## INFORMATION

## PROFILE DETAIL

\* mm

This showcase with aluminium frame and acrylic lockable door includes a background made of cork. Featuring a side locker. This bulletin board exhibits your important information in hallways, classrooms, vestibules, reception rooms or more! The single lockable door ensures that documents, graphics or pictures stay clean and undisturbed.

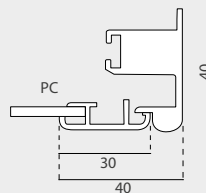

## ROSTOCK SIZES

ROSTOCK	SIZES
14.084	500x700mm
14.085	600x800mm
14.086	700x1000mm

## ROSTOCK



\* Pins at this page are available but not included.

## BOARD DETAILS



## INFORMATION

\* W: Width H: Height

This showcase with aluminium frame and acrylic lockable door includes a metallic background. Featuring rounded corners and a front locker. This enclosed bulletin board provides a perfect display space for postings such as announcements or creative advertisements. The single lockable door ensures that documents, graphics or pictures stay clean and undisturbed.

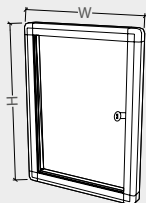

HESSEN	SIZES
14.092	250x400mm
14.045	350x500mm
14.046	500x700mm
14.093	600x600mm

## HESSEN



## BOARD DETAILS



## INFORMATION

PROFILE DETAIL \* mm

This showcase with aluminium frame and acrylic lockable door includes a metallic background. Featuring a side locker. This enclosed bulletin board provides a perfect display space for postings such as announcements or creative advertisements. The single lockable door ensures that documents, graphics or pictures stay clean and undisturbed.

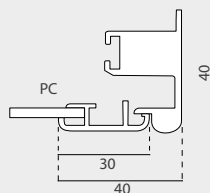

WISSMAR	SIZES
14.087	500x700mm
14.088	600x800mm
14.089	700x1000mm

## WISSMAR



\* Magnets at this page are available but not included.

## BOARD DETAILS



## DIMENSIONS

\* mm

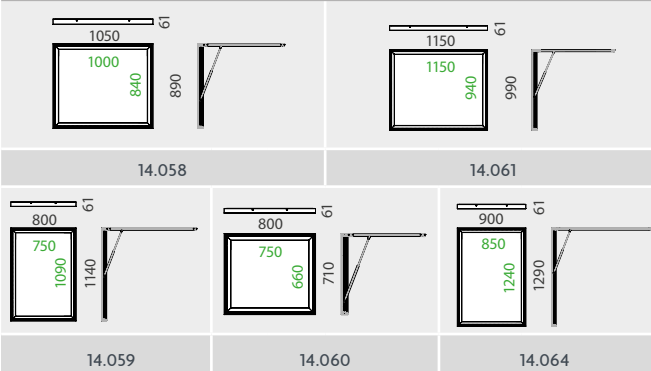

## INFORMATION

## PROFILE DETAIL

\* mm

This showcase Metz is suitable for indoor or outdoor use. It features an aluminium frame, a magnetic background and a lockable door with side locker. Also there are 5 sizes available. The hinge always is mounted on width dimension. It is ideal to be mounted on the wall (hangers included) or directly to the floor using the base feet (which are available but sold separately).

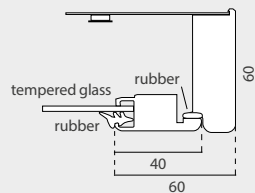

Aluminium thickness: 1.5mm to 1.8mm  
Tempered Glass Thickness: 3mm

METZ	MODEL	WIDTH x HEIGHT
14.058		1000x840mm
14.059		750x1090mm
14.060		750x660mm
14.061		1150x940mm
14.064		850x1240mm

## SHOWCASE METZ



\* Base feet at this page are available but not included.

BOARD DETAILS



OUTDOOR SHOWCASE  
LED METZ



DIMENSIONS

PROFILE DETAIL

\* mm

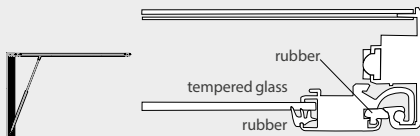
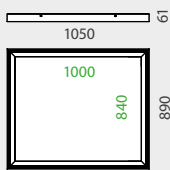

Aluminium thickness: 1mm to 1.8mm  
Tempered Glass Thickness: 4mm

INFORMATION

This showcase Metz is suitable for indoor or outdoor use. It features an aluminium frame, a magnetic background and a lockable door with side locker. Also there are 5 sizes available. The hinge always is mounted on width dimension. It is ideal to be mounted on the wall (hangers included) or directly to the floor using the base feet (which are available but sold separately).



METZ MODEL WIDTH x HEIGHT

14.158  1050x890mm

BASE DETAILS



BASE FEET

1.9m



INFORMATION

DIMENSIONS

\* mm

The base feet are made of aluminium and they are suitable for mounting Metz showcases directly to the floor. The pack includes 2 aluminium poles, 2 endcaps and anchor pieces.

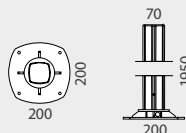

BASE FEET HEIGHT

14.081 Height: 1950mm x2 

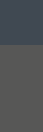



# EVENTS 03

Complete range of promotional walls, counters and flag banners which provide an integral solution for the event exhibition.

- 108** POP UPS
- 121** POP UP ACCESSORIES
- 125** PROMOTION COUNTERS
- 138** TRADESHOW SOLUTIONS
- 148** TRADESHOW SYSTEMS
- 158** TRADESHOW FURNITURE
- 161** OUTDOOR EVENTS
- 162** FLAG BANNERS
- 168** FLAG BANNER ACCESSORIES
- 172** WALL BANNERS
- 178** REFILLABLE BASE BANNERS
- 183** SIDELINE BANNERS



POP UP DETAILS

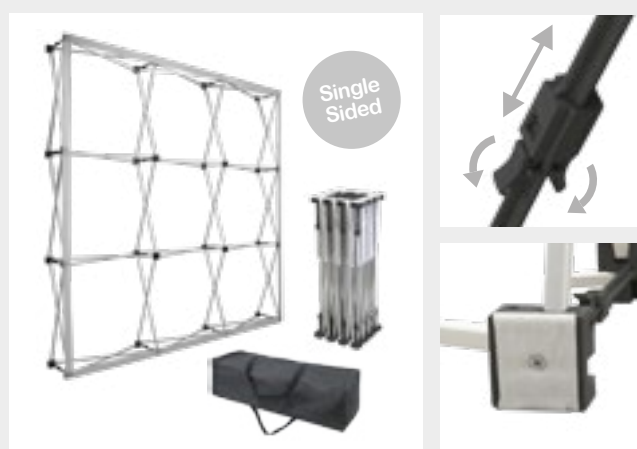

TEXTIL POP UP INSTALATION

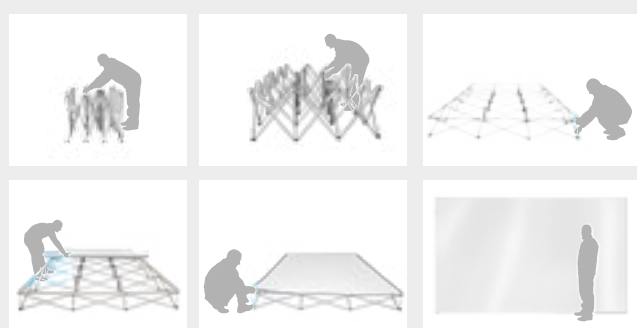

DIMENSIONS

\*mm

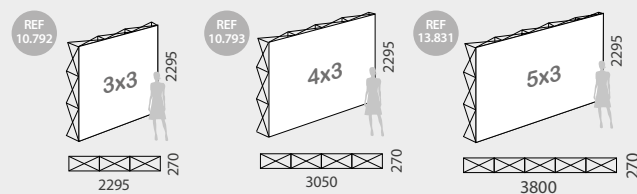

INFORMATION

IPanema Pop-Up features an aluminium frame with locking arms for an easy assemble. Includes 1 soft-case nylon carry bag and 1 roll of genuine VELCRO® brand fasteners for attachment. This straight fabric Pop-Up is one of the most used options for photocalls. The graphics are simple to attach using the brand fasteners in its perimeter. Ideal for promotional acts, weddings, photocalls or at any stand booth.

IPANEMA 3x3	QTY	N.W	G.W	C.B.M	SIZE
Packing	1	7.65kg	8.35kg	0.06	855x235x280mm
<b>10.792</b>	<b>3x3 Graphic Size: 2295x2295mm</b>				
IPANEMA 4x3	QTY	N.W	G.W	C.B.M	SIZE
Packing	1	8.65kg	9.35kg	0.06	855x235x280mm
<b>10.793</b>	<b>4x3 Graphic Size: 3050x2295mm</b>				
IPANEMA 5x3	QTY	N.W	G.W	C.B.M	SIZE
Packing	1	11.6kg	13.2kg	0.07	830x220x380mm
<b>13.831</b>	<b>5x3 Graphic Size: 3800x2295mm</b>				



IPANEMA POP UP



\* VELCRO® is a registered trademark of Velcro BVBA. | VELCRO® est une marque déposée de Velcro Industries B.V. | VELCRO® é uma marca registrada de Velcro Industries B. V. | VELCRO® es una marca registrada de VelcroIndustries B. V.

POP UP DETAILS



DIMENSIONS

\*mm

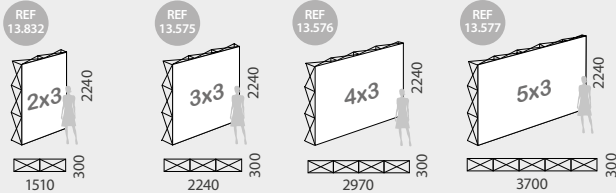

INFORMATION

Surat offers the possibility to fix the graph in the sides of the PopUp (consult the size of the graphics in these cases). Includes 1 soft-case nylon carry bag and 1 roll of genuine VELCRO® brand fasteners for attachment. Surat series feature leveling feet for a suitable adjustment of the PopUp on the surface of the floor.

SURAT 2X3	QTY	N.W	G.W	C.B.M	SIZE
Packing	1	9kg	10kg	0.0747	300x300x830mm
13.832	2x3 Graphic Front: 1510x2240mm Graphic (Front + Sides): 2110x2240mm				
SURAT 3X3	QTY	N.W	G.W	C.B.M	SIZE
Packing	1	9kg	10kg	0.0597	850x260x270mm
13.575	3x3 Graphic Front: 2240x2240mm Graphic (Front + Sides): 2940x2240mm				
SURAT 4X3	QTY	N.W	G.W	C.B.M	SIZE
Packing	1	11kg	12kg	0.0707	850x260x320mm
13.576	4x3 Graphic Front: 2970x2240mm Graphic (Front + Sides): 3670x2240mm				
SURAT 5X3	QTY	N.W	G.W	C.B.M	SIZE
Packing	1	13kg	14kg	0.0774	850x260x350mm
13.577	5x3 Graphic Front: 3700x2240mm Graphic (Front + Sides): 4300x2240mm				



SURAT POP UP

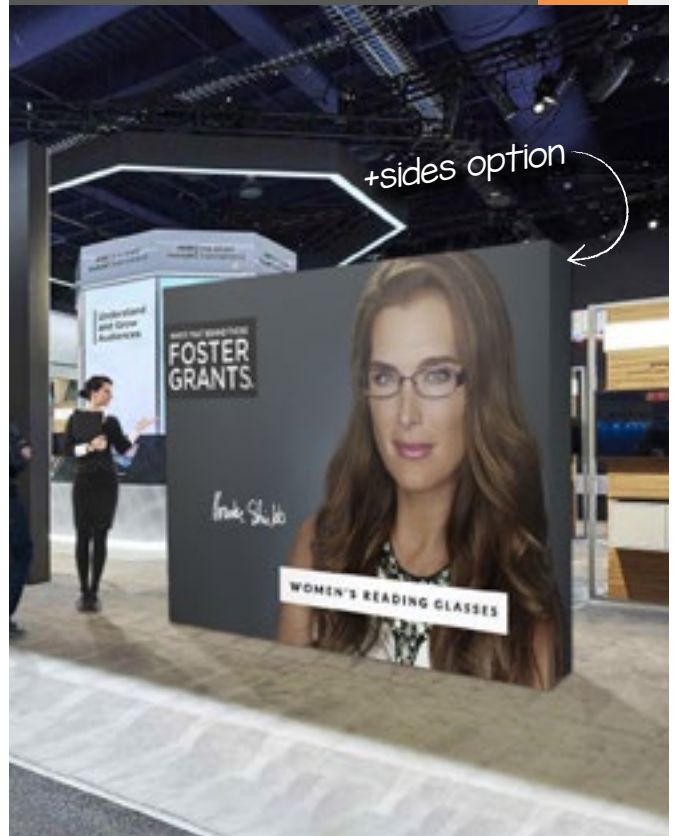

POP UP DETAILS

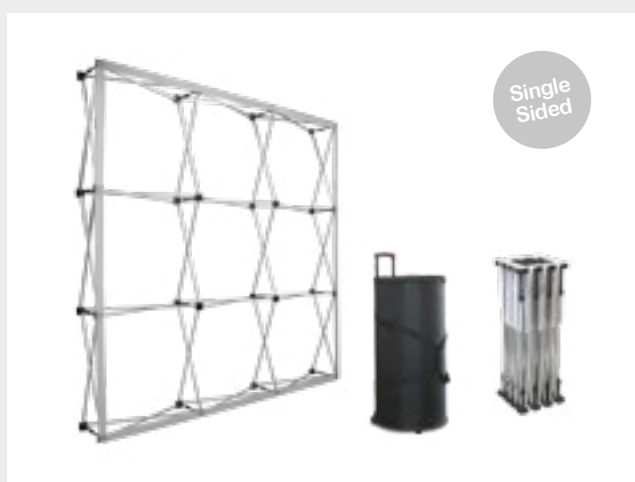

POP UP DETAILS

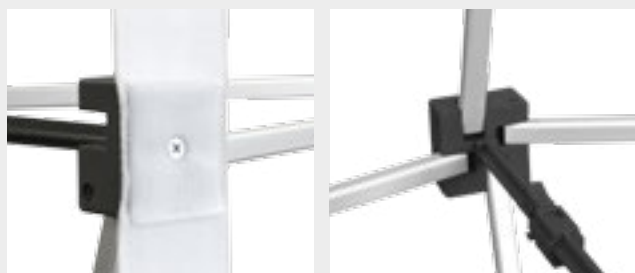

DIMENSIONS

\*mm

REF 10.413

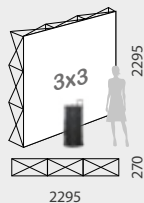

REF 10.414

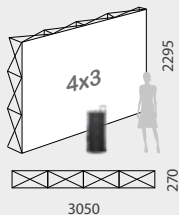

INFORMATION

Cangas Pop-Up is 5 sizes available, featuring an aluminium frame with locking arms for an easy assemble. It includes a trolley Carry Bag and 1 roll of genuine VELCRO® brand fasteners. This straight fabric Pop-Up is one of the most used options for photocalls. The graphics are simple to attach using the brand fasteners in its perimeter. Ideal for promotional acts, weddings, or just for displaying at any stand booth on media events.

CANGAS 3x3	QTY	N.W	G.W	C.B.M	SIZE
Packing	1	13.2kg	15kg	0.2	450x450x950mm
10.413	3x3 Graphic Size: 2295x2295mm				
CANGAS 4x3	QTY	N.W	G.W	C.B.M	SIZE
Packing	1	16.35kg	17.95kg	0.2	450x450x950mm
10.414	4x3 Graphic Size: 3050x2295mm				

CANGAS POP UP



\* Spotlights at this page are available but not included



\* VELCRO® is a registered trademark of Velcro BVBA. | VELCRO® est une marque déposée de Velcro Industries B.V. | VELCRO® é uma marca registrada de Velcro Industries B. V. | VELCRO® es una marca registrada de VelcroIndustries B. V.

POP UP DETAILS

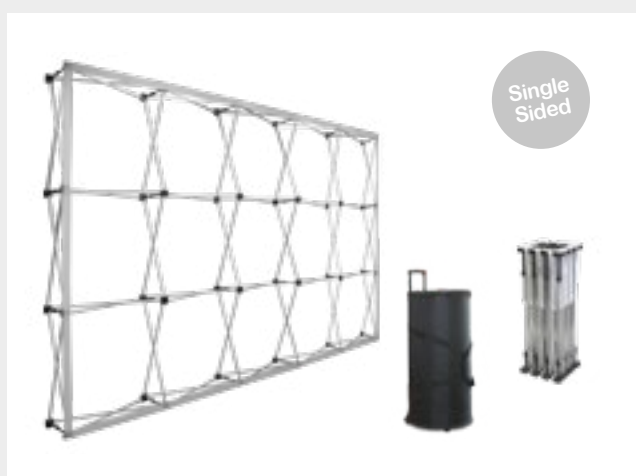

POP UP DETAILS

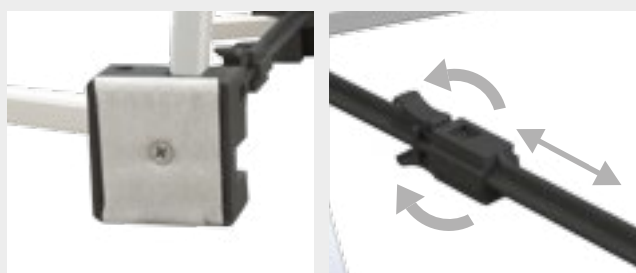

DIMENSIONS \*mm

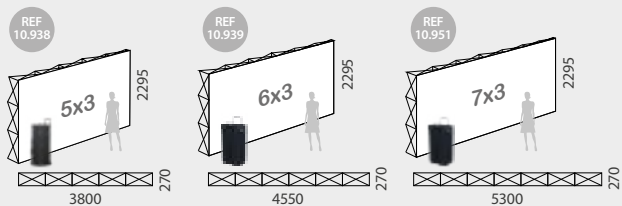

INFORMATION

This straight Textil Pop Up is one of the most used options for photocalls. The model 10.951 is the biggest (2.3x5.3m) Textile Pop Up available. It includes a trolley Carry Bag with wheels and 1 roll of genuine VELCRO® brand fasteners.

CANGAS 5x3	QTY	N.W	G.W	C.B.M	SIZE
Packing	1	16.95kg	18.3kg	0.201	460x460x950mm
<b>10.938</b>	<b>5x3 Graphic Size: 3800x2295mm</b>				
CANGAS 6x3	QTY	N.W	G.W	C.B.M	SIZE
Packing	1	20.50kg	21.9kg	0.201	540x400x950mm
<b>10.939</b>	<b>6x3 Graphic Size: 4550x2295mm</b>				
CANGAS 7x3	QTY	N.W	G.W	C.B.M	SIZE
Packing	1	22.65kg	24.5kg	0.201	540x400x950mm
<b>10.951</b>	<b>7x3 Graphic Size: 5300x2295mm</b>				

CANGAS POP UP



\* Spotlights at this page are available but not included



POP UP DETAILS



POP UP INSTALLATION

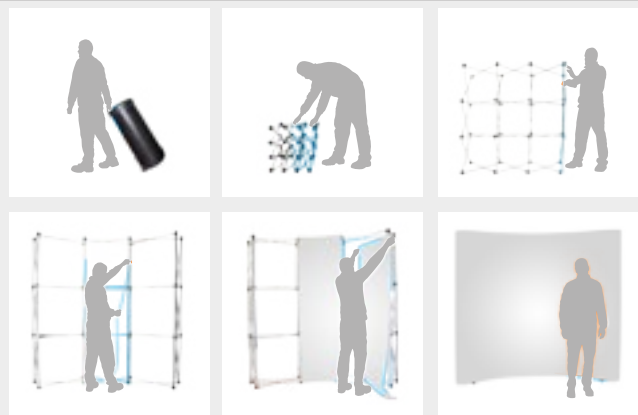

DIMENSIONS

\*mm

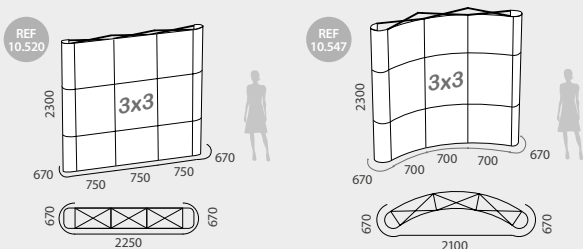

INFORMATION

Laredo 3x3 Pop Up features a straight or curved brushed aluminum frame that is lightweight, yet sturdy. Custom graphics attach to the frame with magnetic loop strips, yet with adhesive to the magnetic strip (1 strip roll is included). Also, 1 nylon trolley carry bag with wheels is included. This portable Pop Up can be set up and taken down in a few minutes. Ideal for enhancing your business's presence at your next media event, exhibition, tradeshow or convention.

3x3 STRAIGHT	QTY	N.W	G.W	C.B.M	SIZE
Packing	1	17.15kg	18.6kg	0.12	390x340x920mm
10.520	Graphic Size:		670x2300mm x2 750x2300mm x3		
3x3 CURVED	QTY	N.W	G.W	C.B.M	SIZE
Packing	1	17.15kg	18.6kg	0.12	390x340x920mm
10.547	Graphic Size:		670x2300mm x2 700x2300mm x3		

LAREDO 3x3



\* Spotlights at this page are available but not included



\* Spotlights at this page are available but not included

POP UP DETAILS

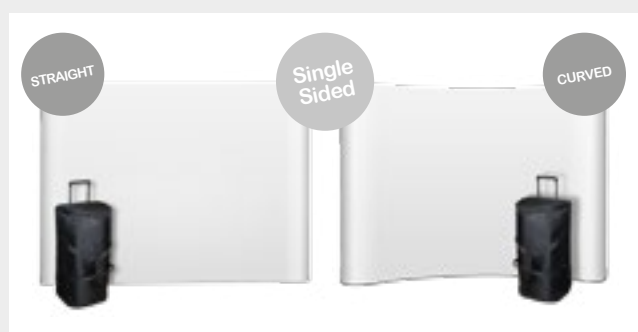

POP UP DETAILS

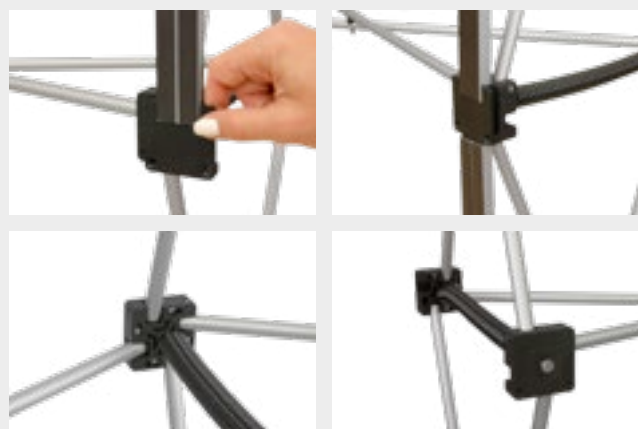

DIMENSIONS

\*mm

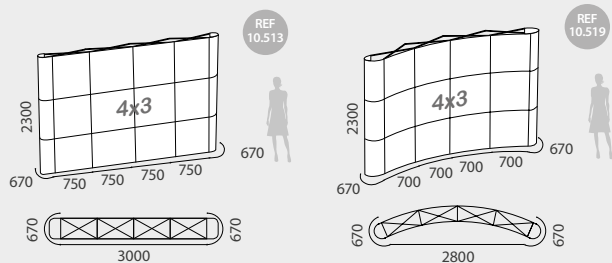

INFORMATION

Laredo 4x3 Pop Up features a straight or curved brushed aluminum frame that is lightweight, yet sturdy. Custom graphics attach to the frame with magnetic loop strips, yet with adhesive to the magnetic strip (1 strip roll is included). Also, 1 nylon trolley carry bag with wheels is included. This portable Pop Up can be set up and taken down in a few minutes. Ideal for enhancing your business's presence at your next media event, exhibition, tradeshow or convention.

4x3 STRAIGHT	QTY	N.W	G.W	C.B.M	SIZE
Packing	1	21.7kg	22.1kg	0.12	390x340x920mm
10.513	Graphic Size:		670x2300mm x2 750x2300mm x4		
4x3 CURVED	QTY	N.W	G.W	C.B.M	SIZE
Packing	1	21.7kg	22.1kg	0.12	390x340x920mm
10.519	Graphic Size:		670x2300mm x2 700x2300mm x4		

LAREDO 4x3



\* Spotlights at this page are available but not included



\* Spotlights at this page are available but not included

POP UP DETAILS



POP UP INSTALATION

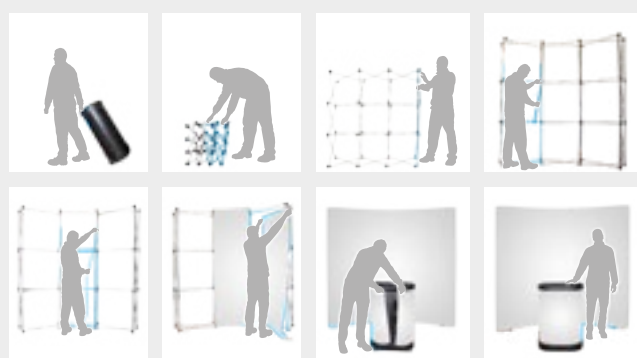

DIMENSIONS

\*mm

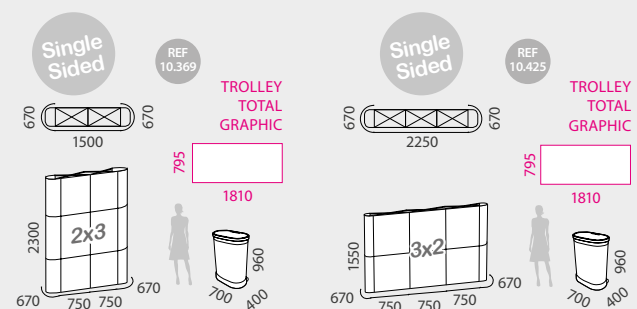

INFORMATION

Madrigal portable Pop Up features a 2x3 or 3x2 brushed aluminum frame that is lightweight, yet sturdy. Custom graphics attach to the frame with magnetic loop strips, yet with adhesive to the magnetic strip (1 strip roll is included). With 2 spotlights, also it includes 1 trolley hard-case with wheels that can be used as a customizable counter (printing is available but not included). Ideal for enhancing your business's presence at your next media event, exhibition, tradeshow or convention.

MADRIGAL 2x3	QTY	N.W	G.W	C.B.M	SIZE
Packing	1	29.4kg	32.6kg	0.32	730x430x1010mm
10.369	Graphic Size:		670x2300mm x2 750x2300mm x2		

MADRIGAL 3x2	QTY	N.W	G.W	C.B.M	SIZE
Packing	1	28.8kg	32kg	0.32	720x430x1010mm
10.425	Graphic Size:		670x1550mm x2 750x1550mm x3		

MADRIGAL 2x3 | 3x2  
STRAIGHT





POP UP DETAILS

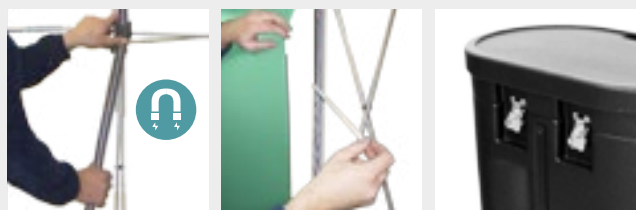
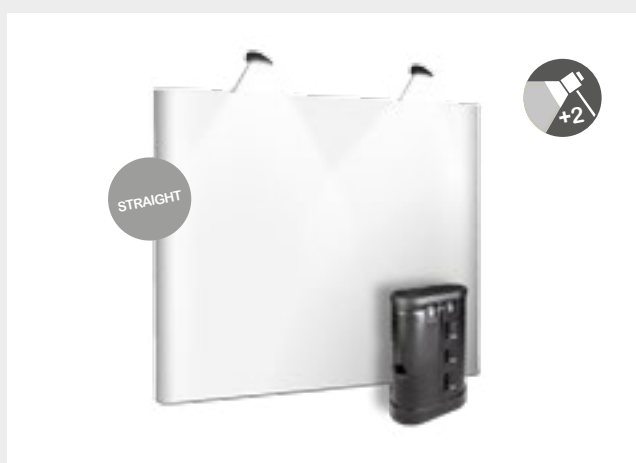

DIMENSIONS

\*mm

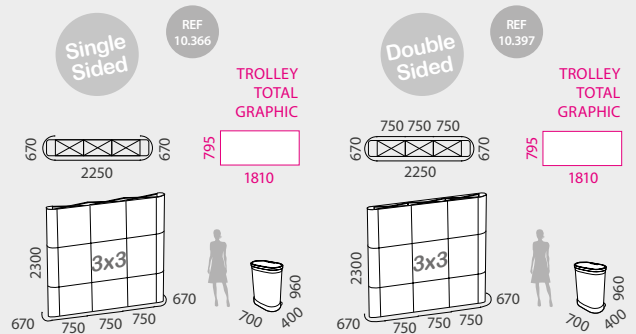

INFORMATION

Madrigal portable 3x3 Straight Pop Up features a brushed aluminum frame which is single-sided or double sided available. Custom graphics attach to the frame with magnetic loop strips, yet with adhesive to the magnetic strip (1 strip roll is included). With 2 spotlights, also it includes 1 trolley hard-case with wheels that can be used as a customizable counter (printing is available but not included). Ideal for enhancing your business's presence at your next media event, exhibition, tradeshow or convention.

3x3 1 SIDE S	QTY	N.W	G.W	C.B.M	SIZE
Packing	1	32.25kg	35.45kg	0.32	730x430x1010mm
10.366	Graphic Size:		670x2300mm x2 750x2300mm x3		

3x3 2 SIDES S	QTY	N.W	G.W	C.B.M	SIZE
Packing	1	34.75kg	37.95kg	0.32	730x430x1010mm
10.397	Graphic Size:		670x2300mm x2 750x2300mm x6		

MADRIGAL 3x3  
STRAIGHT



POP UP DETAILS

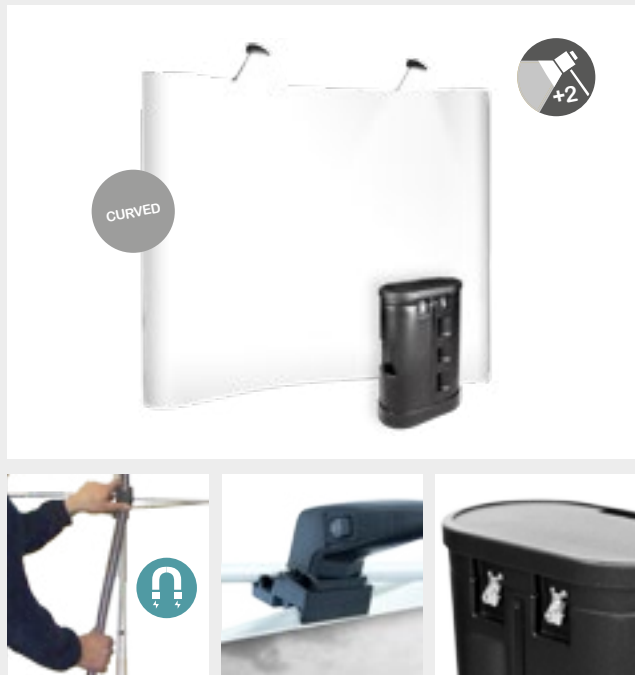

DIMENSIONS

\*mm

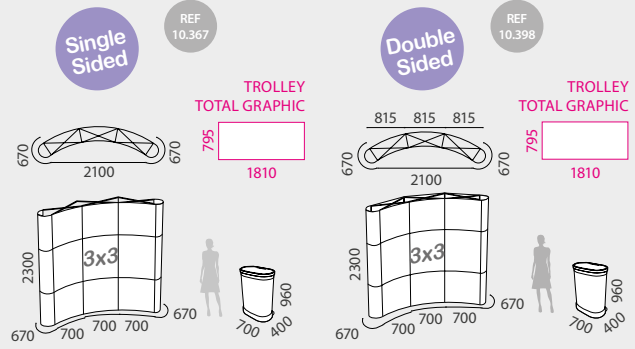

INFORMATION

Madrigal portable 3x3 Curved Pop Up features a brushed aluminum frame which is single-sided or double sided available. Custom graphics attach to the frame with magnetic loop strips, yet with adhesive to the magnetic strip (1 strip roll is included). With 2 spotlights, also it includes 1 trolley hard-case with wheels that can be used as a customizable counter (printing is available but not included). Ideal for enhancing your business's presence at your next media event, exhibition, tradeshow or convention.

3x3 1 SIDE C	QTY	N.W	G.W	C.B.M	SIZE
Packing	1	32.25kg	35.45kg	0.32	730x430x1010mm
10.367	Graphic Size:		670x2300mm x2 700x2300mm x3		

3x3 2 SIDES C	QTY	N.W	G.W	C.B.M	SIZE
Packing	1	34.75kg	37.95kg	0.32	730x430x1010mm
10.398	Graphic Size:		670x2300mm x2 700x2300mm x3 815x2300mm x3		

MADRIGAL 3x3 CURVED



POP UP DETAILS

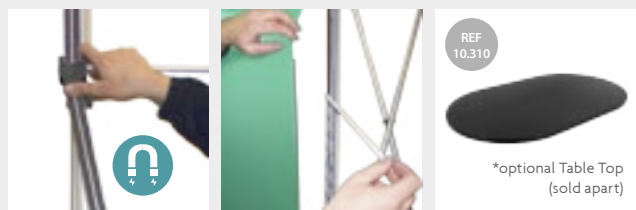

DIMENSIONS

\*mm

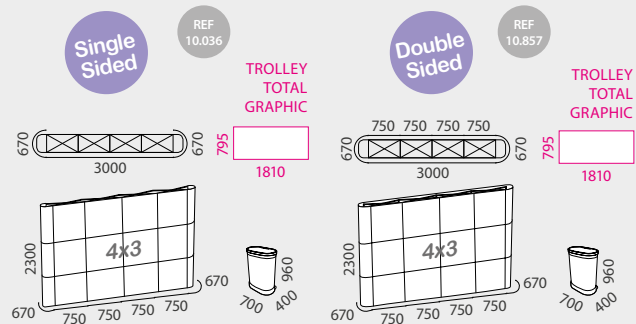

INFORMATION

Madrigal portable 4x3 Straight Pop Up features a brushed aluminum frame which is single-sided or double sided available. Custom graphics attach to the frame with magnetic loop strips, yet with adhesive to the magnetic strip (1 strip roll is included). With 2 spotlights, also it includes 1 trolley hard-case with wheels that can be used as a customizable counter (printing is available but not included). Ideal for enhancing your business's presence at your next media event, exhibition, tradeshow or convention.

4x3 1SIDE S	QTY	N.W	G.W	C.B.M	SIZE
Packing	1	36.3kg	39.5kg	0.32	730x430x1010mm
10.036	Graphic Size:		670x2300mm x2 750x2300mm x4		

4x3 2SIDES S	QTY	N.W	G.W	C.B.M	SIZE
Packing	1	44.5kg	47.7kg	0.32	730x430x1010mm
10.857	Graphic Size:		670x2300mm x2 750x2300mm x8		

MADRIGAL 4x3 STRAIGHT



POP UP DETAILS

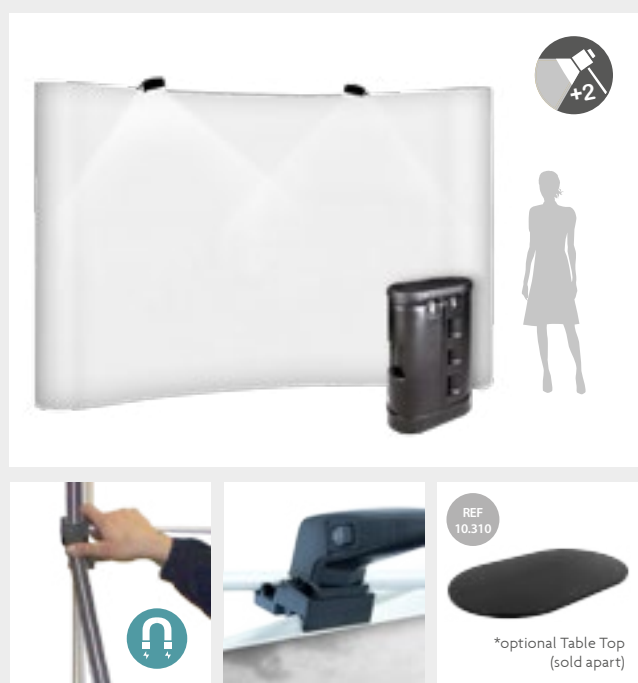

DIMENSIONS

\*mm

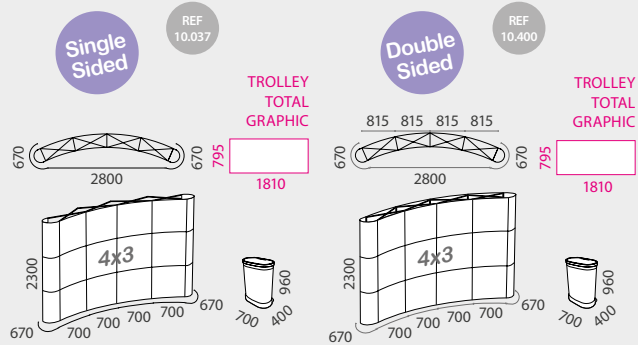

INFORMATION

Madrigal portable 4x3 Curved Pop Up features a brushed aluminum frame which is single-sided or double sided available. Custom graphics attach to the frame with magnetic loop strips, yet with adhesive to the magnetic strip (1 strip roll is included). With 2 spotlights, also it includes 1 trolley hard-case with wheels that can be used as a customizable counter (printing is available but not included). Ideal for enhancing your business's presence at your next media event, exhibition, tradeshow or convention.

4x3 1 SIDE C	QTY	N.W	G.W	C.B.M	SIZE
Packing	1	36.3kg	39.5kg	0.32	710x430x1010mm
10.037	Graphic Size:		670x2300mm x2 700x2300mm x4		

4x3 2 SIDES C	QTY	N.W	G.W	C.B.M	SIZE
Packing	1	44.5kg	47.7kg	0.32	710x430x1010mm
10.400	Graphic Size:		670x2300mm x2 700x2300mm x4 815x2300mm x4		

MADRIGAL 4x3 CURVED



POP UP DETAILS

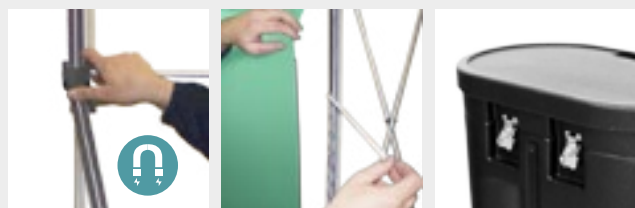

DIMENSIONS

\*mm

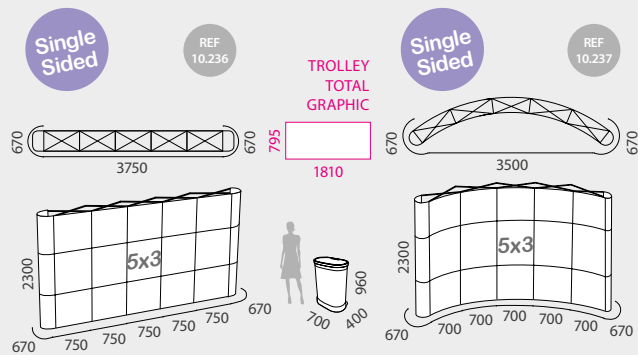

INFORMATION

Madrigal portable 5x3 Pop Up features a brushed aluminum frame which is straight shaped or curved shaped available. Custom graphics attach to the frame with magnetic loop strips, yet with adhesive to the magnetic strip (1 strip roll is included). With 2 spotlights, also it includes 1 trolley hard-case with wheels that can be used as a customizable counter (printing is available but not included). Ideal for enhancing your business's presence at your next media event, exhibition, tradeshow or convention.

5x3 STRAIGHT	QTY	N.W	G.W	C.B.M	SIZE
Packing	1	40.1kg	43.3kg	0.32	730x430x1010mm
10.236	Graphic Size:		670x2300mm x2 750x2300mm x5		

5x3 CURVED	QTY	N.W	G.W	C.B.M	SIZE
Packing	1	40.1kg	43.3kg	0.32	730x430x1010mm
10.237	Graphic Size:		670x2300mm x2 700x2300mm x5		

MADRIGAL 5x3



POP UP DETAILS



DIMENSIONS

\*mm

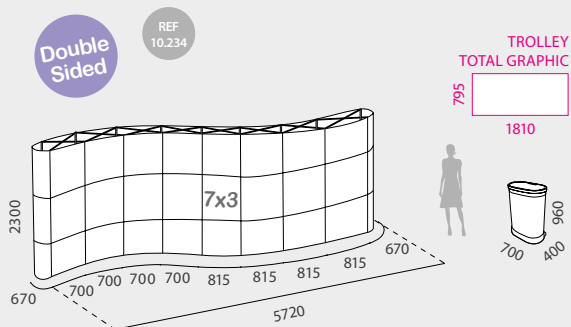

INFORMATION

Teide 8x3 double sided display is the biggest Pop Up, featuring a brushed aluminum frame. Custom graphics attach to the frame with magnetic loop strips, yet with adhesive to the magnetic strip (1 strip roll is included). With 4 spotlights for accenting your graphics. Also, it includes 2 trolley hard-cases with wheels that can be used as counters, and wraps for the cases can be customized with printed graphics (printing is available but not included). Ideal for enhancing your business's presence at your next media event, exhibition, tradeshow or convention.

TEIDE S	QTY	N.W	G.W	C.B.M	SIZE
Packing	2	35.6kg 30kg	36.6kg 31kg	0.32 0.32	730x430x1010mm 730x430x1010mm
10.234	Graphic Size:		670x2300mm x2 700x2300mm x8 815x2300mm x8		

TEIDE 8x3

Biggest Pop-Up



# POP UP ACCESSORIES Trolleys and Cases | Table Top

## ESCALONA SOFT-CASE TROLLEY



### INFORMATION

Made of Nylon with closures and zippers, 2 handle straps, 1 extendable handle and wheels. Escalona is ideal for protecting and transporting Pop Ups.

ESCALONA	QTY	N.W	G.W	C.B.M	SIZE
Packing	1	15kg	18.6kg	0.12	680x170x1030mm
10.060	Trolley Size: 420x420x790mm				

## NOVES HARD-CASE TROLLEY



### INFORMATION

Made of hard PVC, design lasts through long-term uses. Includes high-quality clasps and rubber wheels. Ideal for being labelled and used as counter.

NOVES	QTY	N.W	G.W	C.B.M	SIZE
Packing	1	7kg	9.1kg	0.18	410x430x1000mm
10.059	Graphic size for Counter: 1450x745mm				

## MAQUEDA TROLLEY HARD-CASE



### INFORMATION

Made of hard PVC, design lasts through long-term uses. Includes high-quality clasps, rubber wheels and handles. Ideal for carrying case makes easy to transport your trade show accessories and exhibits in between events.

MAQUEDA	QTY	N.W	G.W	C.B.M	SIZE
Packing	1	13kg	15.2kg	0.32	710x420x1010mm
10.058	Trolley: 700x400x960mm Graphic: 1810x795mm				

## TABLE TOP FOR POP UP

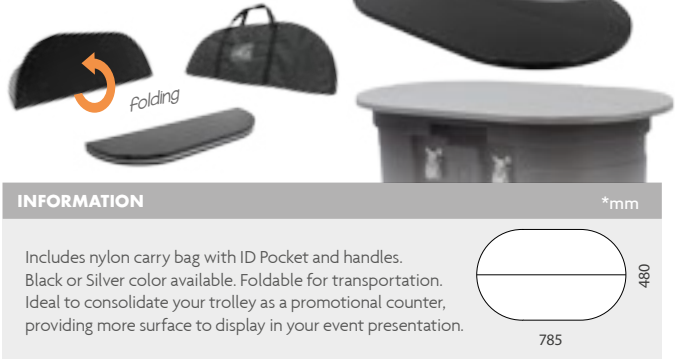

### INFORMATION

Includes nylon carry bag with ID Pocket and handles. Black or Silver color available. Foldable for transportation. Ideal to consolidate your trolley as a promotional counter, providing more surface to display in your event presentation.

TABLE TOP	QTY	N.W	G.W	C.B.M	SIZE
Uni.	1	4.2kg	5.0kg	0.05	830x270x220mm
10.309	785x480x16mm				
10.310					

## TROLLEY SOFT-CASE



### INFORMATION

Trolley made of black nylon with closures and zippers, 2 handle straps, 1 extendable handle and wheels.

TROLLEY S.C.1	QTY	N.W	G.W	C.B.M	SIZE
Packing	1	3.75kg	5.7kg	0.13	455x265x1160mm
13.456	420x230x1080mm				

## TROLLEY SOFT-CASE



### INFORMATION

Trolley made of black nylon with closures and zippers, 2 handle straps, 1 extendable handle and wheels.

TROLLEY S.C.2	QTY	N.W	G.W	C.B.M	SIZE
Packing	1	4.15kg	5.5kg	0.12	440x340x820mm
13.457	420x275x670mm				

\* Counter is not included / Présentoir non inclus / Balcão não incluídos / Mostrador no incluido.

\* Counter is not included / Présentoir non inclus / Balcão não incluídos / Mostrador no incluido.

## TOP AND BOTTOM BAR GRAPHIC (3x3)

- EN Top and bottom bars pack for Pop Up 3x3.
- FR Kit de bandes de suspension pour Pop Up 3x3.
- PT Kit de tiras de suspensão para Pop Up 3x3.
- ES Pack de Perchas/Zócalos para Pop Up 3x3.



### INFORMATION 3x3 Pop Ups

- Available Pack of 10 bars for **Straight 3x3 Pop Up** (5 Bottom and 5 Top).
- Available Pack of 6 bars for **Back curved 3x3 Pop Up** (3 Bottom and 3 Top).
- Available Pack of 10 bars for **Front curved 3x3 Pop Up** (5 Bottom and 5 Top).

STRAIGHT BAR	QTY	N.W	G.W	C.B.M	SIZE
Packing	10	0.68kg	0.7kg	0.0008	55x20x750mm
10.714	Straight 3x3		Pack: 5 Bottom + 5 Top		

C.FRONT BAR	QTY	N.W	G.W	C.B.M	SIZE
Packing	10	0.7kg	0.72kg	0.0007	55x20x700mm
10.715	Curved/Front 3x3		Pack: 5 Bottom + 5 Top		

C.BACK BAR	QTY	N.W	G.W	C.B.M	SIZE
Packing	6	0.46kg	0.48kg	0.0004	55x10x810mm
10.491	Curved/Back 3x3		Pack: 3 Bottom + 3 Top		

## TOP AND BOTTOM BAR GRAPHIC (4x3)

- EN Top and bottom bars pack for Pop Up 4x3.
- FR Kit de bandes de suspension pour Pop Up 4x3.
- PT Kit de tiras de suspensão para Pop Up 4x3.
- ES Pack de Perchas/Zócalos para Pop Up 4x3.

### INFORMATION 4x3 Pop Ups

- Available Pack of 12 bars for **Straight 4x3 Pop Up** (6 Bottom and 6 Top).
- Available Pack of 8 bars for **Back curved 4x3 Pop Up** (4 Bottom and 4 Top).
- Available Pack of 12 bars for **Front curved 4x3 Pop Up** (6 Bottom and 6 Top).

STRAIGHT BAR	QTY	N.W	G.W	C.B.M	SIZE
Packing	12	0.83kg	0.85kg	0.0008	55x20x750mm
10.716	Straight 4x3		Pack: 6 Bottom + 6 Top		

C.FRONT BAR	QTY	N.W	G.W	C.B.M	SIZE
Packing	12	0.78kg	0.8kg	0.0007	55x20x700mm
10.717	Curved/Front 4x3		Pack: 6 Bottom + 6 Top		

C.BACK BAR	QTY	N.W	G.W	C.B.M	SIZE
Packing	8	0.6kg	0.62kg	0.0004	55x15x810mm
10.492	Curved/Back 4x3		Pack: 4 Bottom + 4 Top		

## MAGNETIC BAR

- EN Magnetic bar. Suitable for models: Madrigal, Gredos, Arévalo, Laredo and Llanes.
- FR Barre magnétique. Compatible avec: Madrigal, Gredos, Arevalo, Laredo et Llanes.
- PT Barra magnética compatível com: Madrigal, Gredos, Arevalo, Laredo, Llanes.
- ES Barra magnética. Válida en modelos: Madrigal, Gredos, Arévalo, Laredo y Llanes.



720mm bar For Pop Up

### INFORMATION

- See model of Pop Up for compatibility.
- With rail to insert the adhesive magnetic strip.
- Bars for construction of magnetic structures for Pop Ups.

MAGNETIC BAR	QTY	N.W	G.W	C.B.M	SIZE
Packing	1	0.2kg	0.22kg	0.0003	50x10x760mm 
10.419	720mm				

## MAGNETIC STRIP ROLL 12mm



- EN Magnetic strip roll, 50 metres length for fixing Pop Up graphics.
- FR Rouleau magnétique de 50m pour la fixation des images au Pop Up.
- PT Rolo magnético com 50 metros para fixar impressões de Pop Up.
- ES Rollo de imán de 50 metros para la fijación de gráficas de Pop Up.

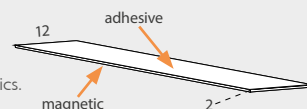

### INFORMATION

- 50m Roll.
- 2mm thickness strip.
- One adhesive side for fixing to the graphics.



M.STRIP ROLL	QTY	N.W	G.W	C.B.M	SIZE
Packing	1	3.4kg	3.82kg	0.0038	390x25x390mm  
10.360	50m roll				



# POP UP ACCESSORIES Assembly Pieces | PVC Panel

## PVC PANNEL FOR POP UPS

EN PVC pannel for Pop Up.  
FR Panneau en PVC pour Pop Up.

PT Painel de PVC para Pop Up.  
ES Panel de PVC para Pop Up.

### INFORMATION

\*mm

- Made of 0.4mm white PVC.
- Ideal for printing graphics for Pop Up.

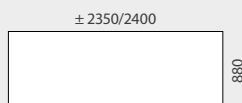

high-quality  
white 0.4mm PVC



PVC PANNEL	QTY	N.W	G.W	C.B.M	SIZE
Packing	1	1.15kg	2.5kg	0.015	130x130x890mm
10.101	±2350/2400x880x0.4mm				

## CONNECTING PIECES FOR POP UPS



### PLASTIC PIECE FOR MAGNETIC BAR

### PLASTIC PIECE FOR POP UP CORNER

### PLASTIC PIECE FOR BAR GRAPHICS

\*mm

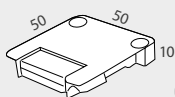

REF 10.858

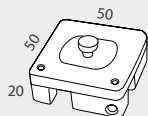
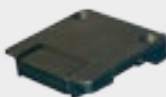

REF 10.409

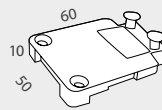

REF 10.859



PIECE M.	QTY	N.W	G.W	C.B.M	SIZE
Packing	1	0.014kg	0.015kg	0.00002	50x10x50mm
10.858	50x50x10mm				

CORNER	QTY	N.W	G.W	C.B.M	SIZE
Packing	1	0.038kg	0.039kg	0.00007	50x30x50mm
10.409	50x50x20mm				

PIECE B.	QTY	N.W	G.W	C.B.M	SIZE
Packing	1	0.02kg	0.021kg	0.00006	55x20x60mm
10.859	60x50x10mm				

## CROSS FOR TEXTIL POP UPS



### INFORMATION

Cross of replacement for structures on Pop Ups with genuine VELCRO® brand system.

CROSS F.P.U.	QTY	N.W	G.W	C.B.M	SIZE
Packing	1	0.70kg	0.80kg	0.005	80x80x800mm
96.117					

## HORIZONTAL CROSS FOR MAGNETIC POP UPS



### INFORMATION

One unit cross of replacement for structures on Pop Ups with magnetic system.

HORIZONTAL C.	QTY	N.W	G.W	C.B.M	SIZE
Packing	1	0.70kg	0.80kg	0.005	80x80x800mm
10.897					

\* VELCRO® is a registered trademark of Velcro BVBA. | VELCRO® est une marque déposée de Velcro Industries B.V. | VELCRO® é uma marca registrada de Velcro Industries B.V. | VELCRO® es una marca registrada de VelcroIndustries B.V.

SPOTLIGHT DETAILS





INFORMATION

\*mm

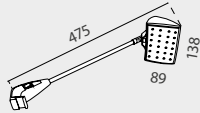
- Clamp base.
- 10W LED light included.
- Ideal for illuminating your exhibit booth and shed light on your displayed products and promotions.



ECONOMIC L.S.	QTY	N.W	G.W	C.B.M	SIZE	
Packing	30	0.3kg	11kg	0.1028	605x515x330mm	
13.753			10 W		18V	

ECONOMIC LED SPOTLIGHT FOR POP UP



SPOTLIGHT FOR POP UP



INFORMATION

\*mm

- Double clamp base.
- 150w light included.
- Ideal for illuminating your exhibit booth and shed light on your displayed products and promotional services.

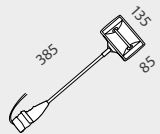

SPOTLIGHT	QTY	N.W	G.W	C.B.M	SIZE
Packing	1	0.65kg	0.7kg	0.0038	150x50x510mm
10.368			150 w		

OXFORD BAG FOR POP UP SPOTLIGHTS

BAG DETAILS



easy transport by handle



INFORMATION

\*mm

- Made of black nylon and all crossed zipped.
- The Oxford Bag protects and extends the life of your Pop Up Spotlights. Easy transport by handles.

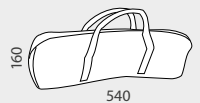

OXFORD BAG	QTY	N.W	G.W	C.B.M	SIZE
Packing	1	0.15kg	0.20kg	0.002	160x30x540mm
13.455					

\* Spotlights not included / Spotlights non inclus / Focos não incluídos / Focos no incluidos.

COUNTER DETAILS



COUNTER DETAILS



DIMENSIONS

ARTWORK

\*mm

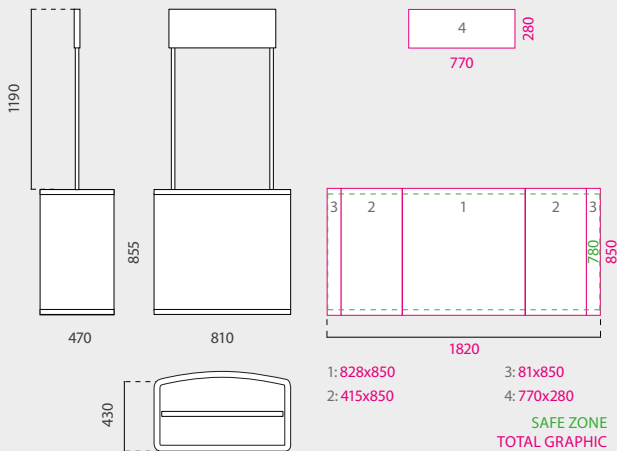

INFORMATION

This counter comes with carry bag and exhibitors can quickly assemble it in a few minutes (no tools required). Once it has been assembled, the counter is lightweight enough to be moved with ease by one person. It has 1 plastic shelf in the interior, so the extra brochures, business cards and flyers can be stored out of sight so your exhibition always appears clean and organized. This counter has a header of 770x280mm for displaying company logos or graphs. Each counter that comes with a header, is excellent for tradeshows and promotional events at stores or business presentations.

TAVIRA



TAVIRA	QTY	N.W	G.W	C.B.M	SIZE
Packing	1	7.35kg	8.95kg	0.073	840x100x880mm

10.098 Total Size Counter: 810x470x2045mm

COUNTER DETAILS



EXTERNAL SIZE

ARTWORK

\*mm

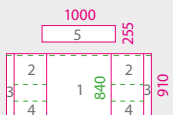
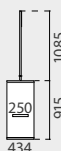
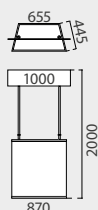

SAFE ZONE  
TOTAL GRAPHIC

- 1: 870x910
- 2: 445x435
- 3: 100x910
- 4: 445x240
- 5: 1000x255

INFORMATION

The Salmoral Counter has 1 plastic shelf in the interior of the display for a better storing and it includes a nylon carry bag. This lightweight counter has a header of 1000x255mm for displaying company logos or graphs. Exhibitors can quickly assemble it in less than 5 minutes (no tools required). Excellent for tradeshows and promotional acts at stores, supermarkets or for business presentations.

SALMORAL	QTY	N.W	G.W	C.B.M	SIZE
Packing	1	6.8kg	8.25kg	0.051	560x70x1300mm
10.043	Total Size Counter: 1000x434x2000mm				

SALMORAL



COUNTER DETAIL

EXTERNAL SIZE

ARTWORK

\*mm

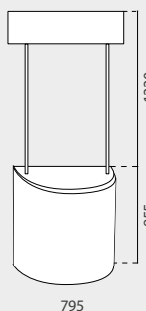

SAFE ZONE  
TOTAL GRAPHIC

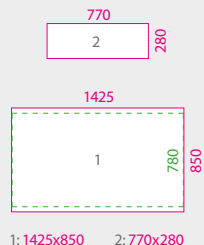

- 1: 1425x850
- 2: 770x280

INFORMATION

This counter comes with carry bag and exhibitors can quickly assemble it in a few minutes (without tools). It has 1 plastic shelf in the interior of the display. Belvis features an accessible semicircular design. This counter has a header of 770x280mm for displaying company logos or graphs. Ideal for tradeshows and promotional events at any stores or business presentations.

BELVIS	QTY	N.W	G.W	C.B.M	SIZE
Packing	1	5.8kg	7.7kg	0.09	860x120x870mm
10.719	Total Size Counter: 795x440x2075mm				

BELVIS

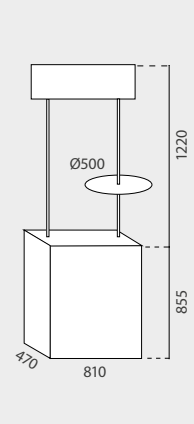

COUNTER DETAIL      DIMENSIONS      ARTWORK      \*mm

**TOTAL GRAPHIC**

770  
3      280

4   2   1   2   4      850

1: 824x850      3: 770x280  
2: 408x850      4: 115x850

**INFORMATION**

This counter comes with carry bag and exhibitors can quickly assemble it in a few minutes (no tools required). It has 1 circular Ø500mm shelf for one pole and 1 plastic shelf in the interior of the display. This counter has a header of 770x280mm for displaying company logos or graphs. It is excellent for tradeshows and promotional events at stores or business presentations.

MANCHESTER	QTY	N.W	G.W	C.B.M	SIZE
Packing	1	9.5kg	10.5kg	0.08	860x110x880mm
10.676	Total Size Counter: 810x470x2075mm				

MANCHESTER

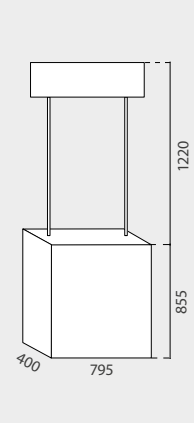

COUNTER DETAIL      DIMENSIONS      ARTWORK      \*mm

**TOTAL GRAPHIC**

770  
3      280

4   2   1   2   4      850

1: 824x850      3: 770x280  
2: 408x850      4: 115x850

**INFORMATION**

This counter comes with carry bag and exhibitors can quickly assemble it in less than 5 minutes (no tools required). It has 1 plastic shelf in the interior of the display. Featuring a sleek blacklenned look design, allowing the display to stand out against any background. With a displaying header of 770x280mm, Lake Counter is excellent for tradeshows, stores or business presentations.

LAKE	QTY	N.W	G.W	C.B.M	SIZE
Packing	1	8.5kg	9.5kg	0.08	860x110x880mm
10.675	Total Size Counter: 795x400x2075mm				

LAKE



## COUNTER DETAILS



### ARTWORK \*mm

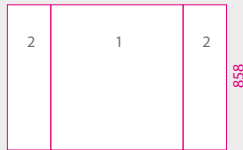
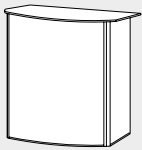

#### TOTAL GRAPHIC

1: 1004x858  
2: 322x858

## INFORMATION

This Counter has an aluminium frame and two internal shelves to give the promo stands support and provide storage space. Also it features 2 lockable doors. The top counter shelf has a wooden finish, yet attractive display. It is assembled and disassembled quickly and stored into a carrying bag.

SIGÜENZA	QTY	N.W	G.W	C.B.M	SIZE
Packing	1	27kg	30kg	0.23	950x200x1250mm
10.493					

## SIGÜENZA



## COUNTER DETAILS



### ARTWORK \*mm

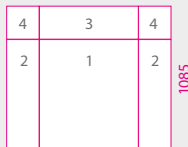

#### TOTAL GRAPHIC

1: 1004x858    3: 1122x227  
2: 322x858    4: 212x227

## INFORMATION

The Sepulveda Counter has an aluminium frame and 3 shelves (2 internal) to give the stands support and provide storage space, with third shelf the counter has an added desk. Also features 2 lockable doors. The top counter shelf has a wooden finish. It is assembled and disassembled quickly and stored into a carrying bag

SEPULVEDA	QTY	N.W	G.W	C.B.M	SIZE
Packing	1	36.8kg	41.9kg	0.18	940x160x1190mm
10.494					

## SEPULVEDA



## COUNTER DETAILS

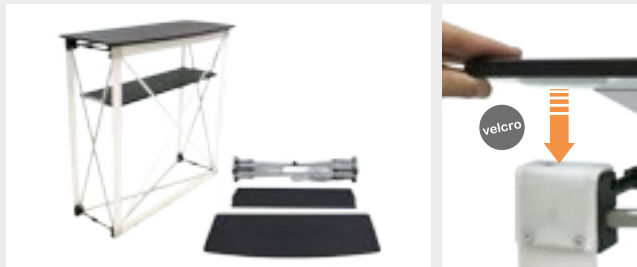

## EXTERNAL SIZE ARTWORK \*mm

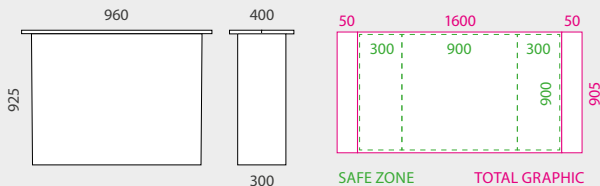

## INFORMATION

Ajalvir is a very fast assembly counter thanks to its genuine VELCRO® brand fasteners system. Features 2 blackened wooden shelves (foldable top) and a carry bag. Ideal for tradeshows, promotional events at stores or business presentations.

AJALVIR	QTY	N.W	G.W	C.B.M	SIZE
Packing	1	8.35kg	9.15kg	0.0609	290x210x1000mm
10.323	Graphic Size: 905x1600mm				

## AJALVIR



## COUNTER DETAILS



## EXTERNAL SIZE ARTWORK \*mm

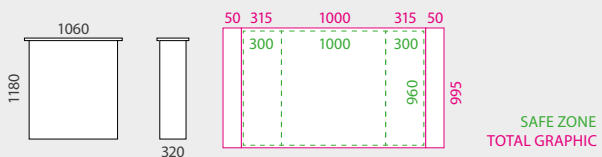

## INFORMATION

Villares is a very fast assembly counter thanks to its genuine VELCRO® brand fasteners system. Features 2 blackened wooden shelves (foldable top) and a carry bag. Ideal for tradeshows, promotional events at stores or business presentations.

VILLARES	QTY	N.W	G.W	C.B.M	SIZE
Bottom	1	3.1kg	6.85kg	0.12	445x230x130mm
Top	1	5.45kg	6.6kg	0.04	465x70x120mm
10.096	Graphic Size: 1730x995mm				

## VILLARES



COUNTER DETAILS



EXTERNAL SIZE

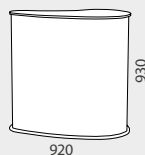

ARTWORK

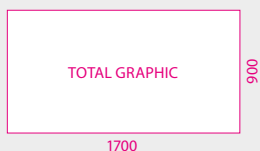

\*mm

INFORMATION

Cezures counter features a black wooden countertop and base. A carrying bag with handles is included. It can be used to hold promotional materials, also known as a portable stand, can be used to conduct a product demonstration. Easy and fast to set up thanks to its genuine VELCRO® brand fasteners system.

CEZURES	QTY	N.W	G.W	C.B.M	SIZE
Packing	2	7.7kg	12kg	0.02	570x380x940mm
10.686	Graphic Size: 1700x900mm				

CEZURES



COUNTER DETAILS

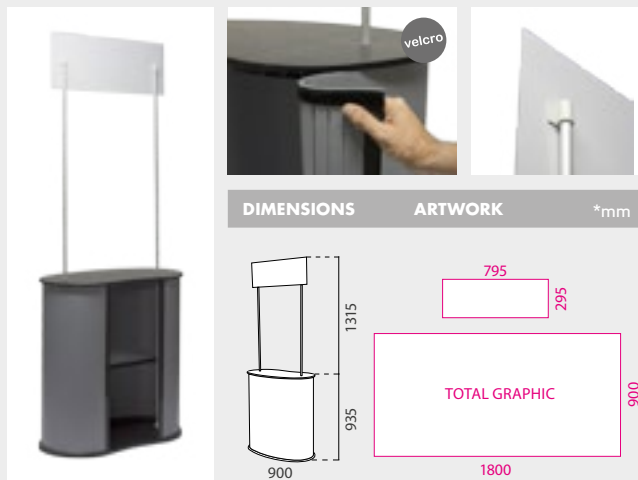

DIMENSIONS

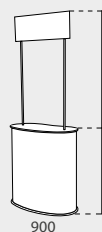

ARTWORK

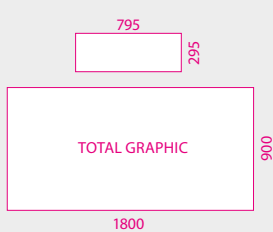

\*mm

INFORMATION

The Atenas Counter features a black wooden countertop and base. Also, it has 1 plastic shelf in the interior and a top header of 795x295mm for displaying your message. A fabric carrying bag with handles is included. Easy and fast to set up thanks to its genuine VELCRO® brand fasteners system. It is ideal for being used at tradeshows, media events or business presentations.

ATENAS	QTY	N.W	G.W	C.B.M	SIZE
Packing	1	25.8kg	27kg	0.21	500x440x940mm
10.312	Graphic Size: 1800x900mm				

ATENAS



\* VELCRO® is a registered trademark of Velcro BVBA. | VELCRO® est une marque déposée de Velcro Industries B.V. | VELCRO® é uma marca registrada de Velcro Industries B. V. | VELCRO® es una marca registrada de Velcro Industries B. V.



COUNTER DETAILS



DIMENSIONS

ARTWORK

\*mm

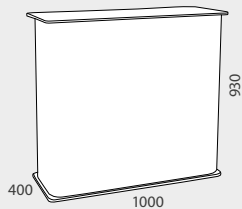

TOTAL GRAPHIC



INFORMATION

This counter comes with carry bag and exhibitors can quickly assemble it in a few minutes (no tools required) thanks to its genuine VELCRO® brand fasteners system. Once it has been assembled, the counter is lightweight enough to be moved with ease by one person. It has 1 shelf in the interior, so the extra brochures, business cards and flyers can be stored out of sight so your exhibition always appears clean and organized. This counter features wood or black finish available. Ideal for tradeshow and promotional events at stores or business presentations.

CAEN	QTY	N.W	G.W	C.B.M	SIZE
Packing	1	16kg	19kg	0.2012	1290x300x520mm

13.845-1  Graphic Size: 2195x900mm

13.845-2  Graphic Size: 2195x900mm

CAEN



COUNTER DETAILS



EXTERNAL SIZE

ARTWORK

\*mm

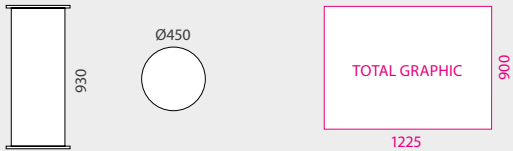

INFORMATION

The Valdes Counter features a circular design that allows the integration of the counter in any space for exhibition and with the advantage of being more accessible than other counters. It has a black wooden countertop and base. It is fast and easy to setup in seconds. A carrying bag with handles is included.

VALDES	QTY	N.W	G.W	C.B.M	SIZE
Packing	2	3.8kg	4.3kg	0.016	460x80x460mm
		2.7kg	3.2kg	0.037	200x200x930mm
10.685		Graphic Size: 1225x900mm			

VALDES



COUNTER DETAILS

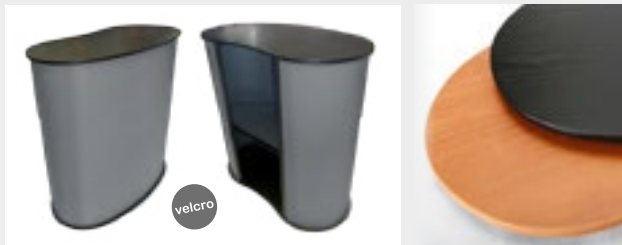

EXTERNAL SIZE

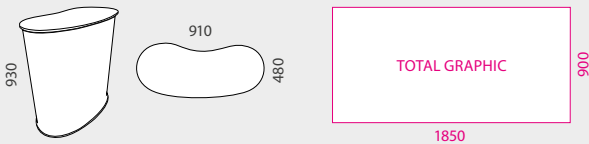

ARTWORK

\*mm



INFORMATION

The Doiras Counter features a black wooden countertop and base. Also, it has 1 plastic shelf in the interior for storing. A nylon carrying bag with handles is included. Doiras Counter is easy to set-up and breakdown in only a few seconds, making it perfect for travelling business people.

DOIRAS	QTY	N.W	G.W	C.B.M	SIZE
Packing	2	12kg	13kg	0.0372	500x80x930mm
		1.5kg	2kg	0.0372	200x200x930mm
13.475		Graphic Size: 1850x900mm			
13.476					

DOIRAS



**new**

COUNTER DETAILS



DOIRAS XXL



DIMENSIONS

ARTWORK

\*mm

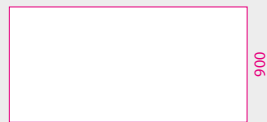
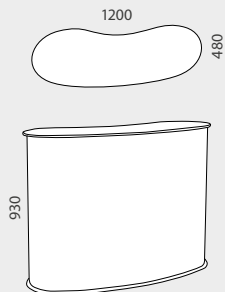

TOTAL GRAPHIC

INFORMATION

Doiras XXL comes with carry bag and exhibitors can quickly assemble it in a few minutes (no tools required) thanks to its genuine VELCRO® brand fasteners system. Once it has been assembled, the counter is lightweight enough to be moved with ease by one person. It has 1 shelf in the interior, so the extra brochures, business cards and flyers can be stored out of sight so your exhibition always appears clean and organized. This counter features wood or black finish available. Ideal for tradeshows and promotional events at stores or business presentations.



CAEN	QTY	N.W	G.W	C.B.M	SIZE
Packing	1	15kg	16kg	0.2126	450x1050x450mm

13.846-1  Graphic Size: 1950x900mm

13.846-2  Graphic Size: 1950x900mm

\* Roll Up in 13846-2 example is available but not included. See it in Chapter 1 Displays.

## COUNTER DETAILS



## DIMENSIONS

## ARTWORK

\*mm

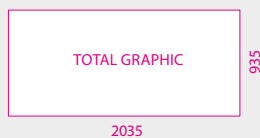
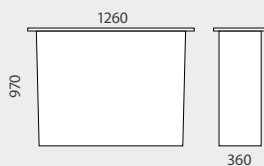

## INFORMATION

This stylish Promotion Counter is completely portable, functional and has 1 shelf in the interior of the display, so your exhibition always appears clean and organized. Also, There are 3 wooden finishes for the top: black, brown or yellow colored. The curved counter is lightweight and includes two carrying cases. Graphics are really easy to attach to the display thanks its magnetic system. Cebreros counter is ideal for various promotional needs are often used to hold product samples, corporate literature, business cards, brochures and more so counter is perfect for a wide variety of promotional applications, including in-store displays, such as grocery 'free sample' promotions.

CEBREROS 1	QTY	N.W	G.W	C.B.M	SIZE
Bottom	1	7.55kg	9.55kg	0.06	380x160x1030mm
Top	1	6.7kg	8.35kg	0.04	460x110x750mm
<b>10.241</b>		<b>Graphic Size: 2035x935mm</b>			
CEBREROS 2	QTY	N.W	G.W	C.B.M	SIZE
Bottom	1	7.55kg	9.55kg	0.06	380x160x1030mm
Top	1	6.7kg	8.35kg	0.04	460x110x750mm
<b>10.392</b>		<b>Graphic Size: 2035x935mm</b>			
CEBREROS 3	QTY	N.W	G.W	C.B.M	SIZE
Bottom	1	7.55kg	9.55kg	0.06	380x160x1030mm
Top	1	6.7kg	8.35kg	0.04	460x110x750mm
<b>10.042</b>		<b>Graphic Size: 2035x935mm</b>			

## CEBREROS



COUNTER DETAILS

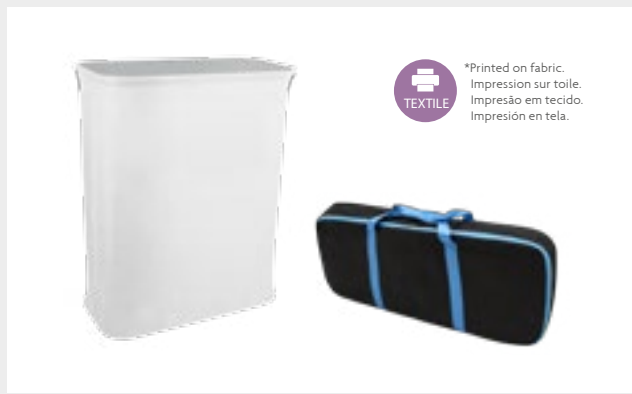

\*Printed on fabric.  
Impression sur toile.  
Impressão em tecido.  
Impresión en tela.



EXTERNAL SIZE

ARTWORK

\*mm

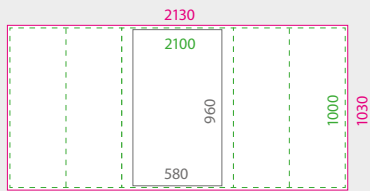
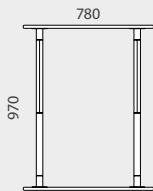

FRONT VIEW  
SAFE ZONE  
TOTAL GRAPHIC



INFORMATION

These Counters are designed for using with fabric wrap (printed on textile) making it lightweight and easy to fold. Also, the Fabric Counters are also simple to setup. All the aluminium poles fit together and snap into place. Simply stretch the wrap over the completed base and it's ready to use. With carry bag for easy travelling. Features a double zip to the interior of the counter for storing, so your exhibition always appears clean and organized. Baracoa is ideal as a lectern or podium at tradeshow, promotional events or conventions and are great to pair with Pop Up banners or any stand.

BARACOA	QTY	N.W	G.W	C.B.M	SIZE
Packing	1	8kg	9.2kg	0.042	860x120x410mm
13.740	Graphic Size: 2130x1030mm				

BARACOA





### COUNTER DETAILS



\*Printed on fabric.  
Impression sur toile.  
Impressão em tecido.  
Impresión en tela.

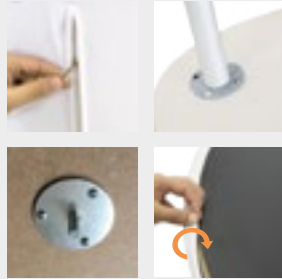

### EXTERNAL SIZE

\*mm

### ARTWORK

### DOWNLOAD

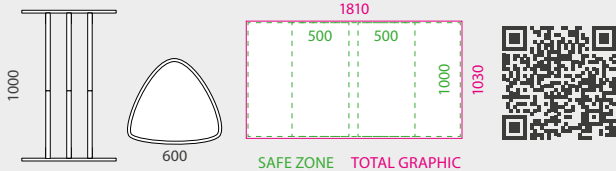

### INFORMATION

Creta is lightweight and easy to fold and setup. With carry bag and a single zip to the interior for storing. Features 3 points of view. Ideal as a lectern or podium at tradeshows, events or conventions.

CRETA	QTY	N.W	G.W	C.B.M	SIZE
Packing	1	11kg	12kg	0.04	650x100x650mm
10.311	Graphic Size: 1810x1030mm				

## CRETA



### COUNTER DETAILS



\*Printed on fabric.  
Impression sur toile.  
Impressão em tecido.  
Impresión en tela.

automatic hydraulic

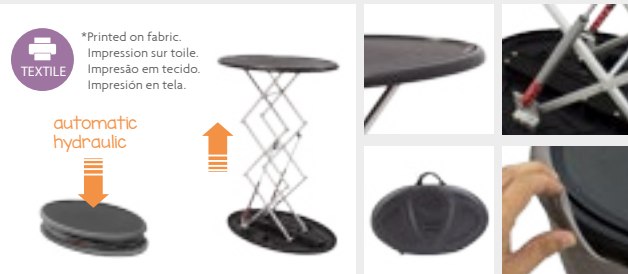

### EXTERNAL SIZE

\*mm

### ARTWORK

### DOWNLOAD

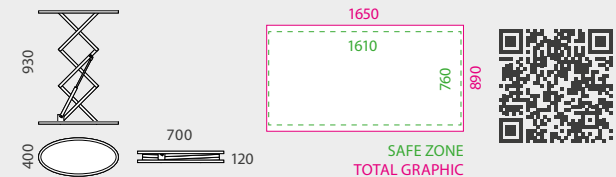

### INFORMATION

Sienna is lightweight and easy to fold and setup. With a hard carry padded bag and a double zip. Features an **hydraulic drive system** for an automatic and quick unfolding with just a slight push on the top of the counter. Ideal for events or conventions and are great to pair with Pop Up banners or any stand.

SIENNA	QTY	N.W	G.W	C.B.M	SIZE
Packing	1	5.6kg	7.6kg	0.21	970x600x360mm
15.244	Graphic Size: 1650x890mm				

## SIENNA

AUTO UNFOLD





### COUNTER DETAILS



\*Printed on fabric.  
Impression sur toile.  
Impressão em tecido.  
Impresión en tela.

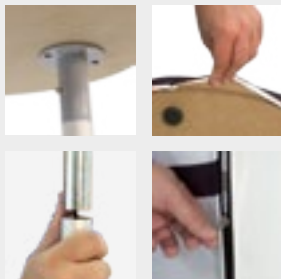

### EXTERNAL SIZE

\*mm

### ARTWORK

### DOWNLOAD

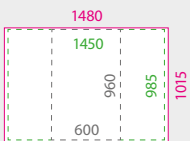
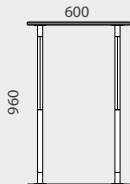

FRONT VIEW SAFE ZONE TOTAL GRAPHIC

### INFORMATION

Manacor is lightweight and fast to setup. Features an oval shape design. With carry bag and a double zip to the interior for storing. Ideal as a lectern or podium at tradeshows, events or conventions.

MANACOR	QTY	N.W	G.W	C.B.M	SIZE
Packing	1	7.0kg	7.44kg	0.0366	440x130x640mm
10.318	Graphic Size: 1480x1015mm				

## MANACOR



### COUNTER DETAILS



\*Printed on fabric.  
Impression sur toile.  
Impressão em tecido.  
Impresión en tela.



### EXTERNAL SIZE

\*mm

### ARTWORK

### DOWNLOAD

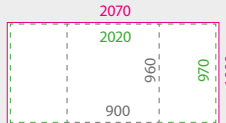
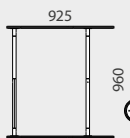

FRONT VIEW SAFE ZONE TOTAL GRAPHIC

### INFORMATION

Mahon is lightweight and easy to assembly. Features the classic raindrop shape design. With carry bag and a double zip to the interior for storing. Ideal as a lectern or podium at promotional events, tradeshows, point of sales.

MAHON	QTY	N.W	G.W	C.B.M	SIZE
Packing	1	10.50kg	10.93kg	0.0672	500x140x960mm
10.319	Graphic Size: 2070x1000mm				

## MAHON



\* Printing is available but not included

### CONTENT

EN

Magnetic Panel System. Using straight frames to which the graphic panel can be attached by means of magnetic strips.  
 • 2 round steel bases. • 2 aluminum poles. • 2 spotlights.  
 • Connectors. • 4 aluminum cases (700x1000mm).  
 • 8 pieces of PS of panel.

FR

Système de panneaux magnétiques. Affichage fixé sur cadre avec ruban magnétique.  
 • 2 bases rondes en acier. • 2 poteaux en aluminium.  
 • Connecteurs. • 4 cadres en aluminium (700x1000mm).  
 • 8 pcs de panneau PS. • 2 foyers.

PT

Sistema de painéis magnéticos. Os painéis são fixados nos marcos mediante barras magnéticas.  
 • 2 bases redondas de aço. • 2 postes de alumínio.  
 • 8 peças de painel PS. • 4 marcos de alumínio (700x1000mm).  
 • 2 focos. • Conectores.

ES

Sistema de panel magnético. Usando marcos rectos a los cuales el panel gráfico puede unirse por bandas magnéticas.  
 • 2 bases redondas de acero. • 2 postes de aluminio.  
 • 8 pcs PS panel. • 4 marcos de aluminio (700x1000mm).  
 • 2 focos. • Conectores.

## VIDAGO PANEL BANNER



spotlights included

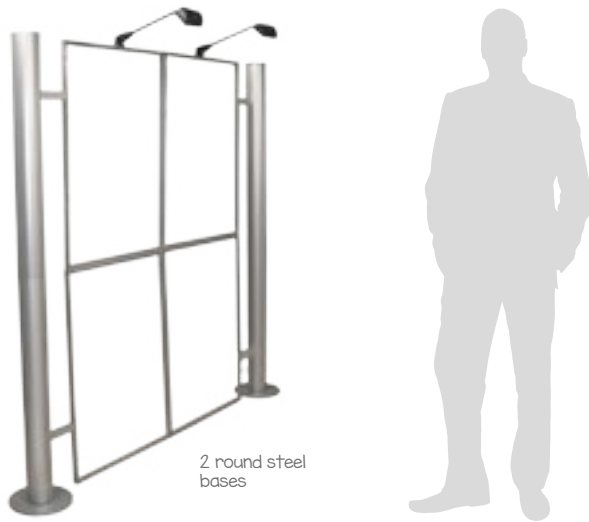

2 round steel bases

### WALL DETAILS



### INFORMATION

This exhibition display unit features 1 backdrop double-sided panel designed for 8 graphic panes. This unit can be easily assembled into an appealing pop up display thanks its magnetic system to fix the panes. Aluminium structure composed by 2 poles, 4 cases and 2 round bases made of steel. Also 2 spotlights are included. Pair this backdrop with some trade show fixtures available on this catalogue, such as counters, iPad mounts, chairs or brochure stands. The exhibition booths, offer a great way to market your business at trade shows, conventions, media events and expos.

VIDAGO	QTY	N.W	G.W	C.B.M	SIZE
Packing	1	34.5kg	35kg	0.40	800x400x1250mm
10.430		Graphic Size: 2100x2000mm			

### EXTERNAL SIZE

### ARTWORK

\*mm

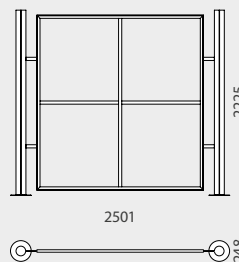

TOTAL GRAPHIC

\* Printing is available but not included.



# CATANIA

## CONTENT

EN

Portable Display Wall. The construction makes an easy and fast assembly.  
 • Aluminium Profile, base feet and two spotlights.  
 • Oxford Cloth bag: 1 unit.

FR

Display portable, facile et rapide à monter.  
 • Profils en aluminium, bases et foyers d'éclairage.  
 • Valise de transport Oxford Cloth: 1 unité.

PT

Display portátil de fácil e rápida montagem.  
 • Perfis de alumínio, bases e focos.  
 • Mala de transporte Oxford Cloth: 1 unidade.

ES

Display portátil de fácil y rápido montaje.  
 • Perfil de aluminio, bases y dos focos.  
 • Bolsa de transporte: 1 unidad.



spotlights included



1 oxford bag included



## WALL DETAILS



## INFORMATION

This portable exhibition display unit features a lightweight, yet sturdy, aluminium profile structure. This unit can be easily assembled fast and easily. The entire portable display can be set up and taken down within minutes. It's composed by 1 aluminium frame structure, 2 round bases and 1 oxford bag for an easy transportation. Also 2 spotlights are included. Pair this backdrop wall with some trade show fixtures available on this catalogue, such as counters, iPad mounts, chairs or brochure stands. The exhibition booths, offer a great way to market your business at trade shows, conventions, media events or expos.

## EXTERNAL SIZE

\*mm

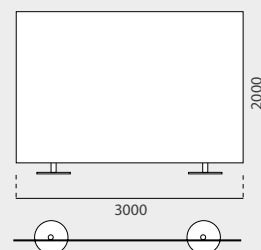

CATANIA	QTY	N.W	G.W	C.B.M	SIZE
Packing	1	15kg	16.2kg	0.14	420x150x1250mm
<b>10.647</b>		<b>Size: 3000x2000mm</b>			

\* Printing is available but not included.

## PERUGIA

### CONTENT

EN

Portable Display Wall. The construction makes an easy and fast assembly.  
 • Aluminium Profile, base feet and two spotlights.  
 • Oxford Cloth bag: 1 unit.

FR

Visuel portable, facile et rapide à monter.  
 • Profils en aluminium, bases et foyers d'éclairage.  
 • Valise de transport Oxford Cloth: 1 unité.

PT

Display portátil de fácil e rápida montagem.  
 • Perfis de alumínio, bases e focos.  
 • Mala de transporte Oxford Cloth: 1 unidade.

ES

Display portátil de fácil y rápido montaje.  
 • Perfil de aluminio, bases y dos focos.  
 • Bolsa de transporte: 1 unidad.



2 spotlights included



Oxford bag included

### INFORMATION

This portable exhibition display unit features a lightweight, yet sturdy, 2x3m aluminium profile structure. This unit can be easily assembled fast and easily. The entire portable display can be set up and taken down within minutes. It's composed by 1 aluminium frame structure, 2 round bases and 1 oxford bag for an easy transportation. Also 2 spotlights are included. Pair this backdrop wall with some trade show fixtures available on this catalogue, such as counters, iPad mounts, chairs or brochure stands. The exhibition booths, offer a great way to market your business at trade shows, conventions, media events or expos.

PERUGIA	QTY	N.W	G.W	C.B.M	SIZE
Packing	1	15kg	16.2kg	0.14	420x150x1250mm
10.648	Graphic Size: 3000x2000mm				

### EXTERNAL SIZE

### ARTWORK

\*mm

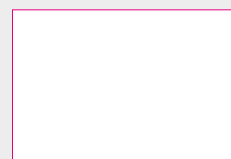
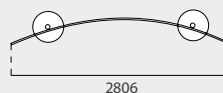

3000

TOTAL GRAPHIC

\* Printing is available but not included.

## CONTENT

EN

- Stable Exhibition System. Fast and easy assembly.
- Aluminium frame 2000x2200mm.
  - Header Board, Shelves: 1.
  - Wings (2 units) (L&R). • V" Shape Table: 1.
  - Spotlights (2 units). • Plastic Packing Case.

FR

- Système d'exposition stable. Montage facile.
- Cadre en aluminium 2000x2200mm.
  - Ailes (2 unités) (L&R).
  - Plaque supérieur Étagère: 1. • "Table en "V": 1.
  - Foyers d'éclairage (2 unités). • Valise en plastique.

PT

- Sistema de exibição estável. De fácil montagem.
- Marco de alumínio 2000x2200mm.
  - Placa superior. Prateleira: 1.
  - Alas (2 unidades) (L&R). • Mesa em forma de "V": 1.
  - Focos (2 unidades).
  - Mala de transporte em plástico.

ES

- Sistema de exhibición estable de fácil montaje.
- Marco de aluminio 2000x2200mm.
  - Placa superior. Estantes: 1.
  - 2 Alas (izquierda, derecha).
  - Mesa en forma de "V": 1.
  - 2 focos. • Maleta de plástico.

## LIMOGES



2 spotlights are included



hand case included

## INFORMATION

This portable exhibition display unit features a lightweight, yet sturdy, 2x2m aluminium profile structure. This unit can be easily assembled fast and easily. The entire portable display can be set up in a few minutes. It's composed by 1 aluminium frame structure, 2 round bases, 1 header board, 2 sides wings, 1 shelf, 1 "V" table, 2 spotlights and 1 hard case. Pair this backdrop wall with some trade show fixtures available on this catalogue, such as counters, iPad mounts, chairs or brochure stands. The exhibition booths, offer a great way to market your business at trade shows, conventions, media events or expos.

LIMOGES	QTY	N.W	G.W	C.B.M	SIZE
Packing	1	52.5kg	54kg	0.44	780x390x1450mm

10.153

## EXTERNAL SIZE

## ARTWORK

\*mm

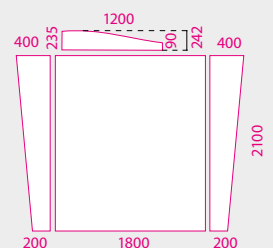
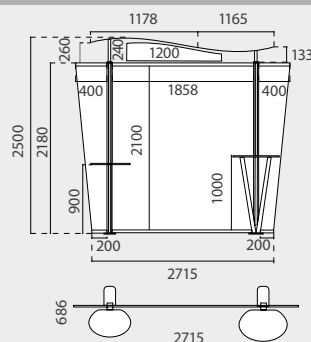

TOTAL GRAPHIC

\* Printing is available but not included.

## CONTENT

EN

Stable Exhibition System. Easy to be assembled.  
 • Aluminium frame 2850x2200mm.  
 • Header Board. Shelves: 3.  
 • Wings (2 units) (L&R). • "V" Shape Table: 1.  
 • Spotlights (3 units). • Plastic Packing Case.

FR

Système d'exposition stable. Montage facile.  
 • Cadre en aluminium 2850x2200mm.  
 • Plaque supérieur. Étagères: 3.  
 • Ailes (2 unités) (L&R). • Foyers d'éclairage (3 unités).  
 • Table en "V": 1. • Valise en plastique: 1 unité.

PT

Sistema de exibição estável. De fácil montagem.  
 • Marco de alumínio 2850x2200mm.  
 • Placa superior. Prateleiras: 3. • Alas (2 unidades) (L&R).  
 • Mala de transporte em plástico: 1.  
 • Mesa em forma de "V": 1. • Focos (3 unidades). Fixador de LCD.

ES

Sistema de exhibición estable. Fácil montaje.  
 • Marco de aluminio 2850x2200mm.  
 • Placa superior. Estantes: 3.  
 • 2 Alas (izquierda, derecha). • Mesa en forma de "V": 1.  
 • 3 focos. • Maleta de plástico.

## OPOLE



Includes 3 spotlights



hard case included

## INFORMATION

Opole is a portable and elegant exhibition display unit formed by a sturdy, 2850x2200mm aluminium structure. This unit can be easily assembled fast and easily. The entire portable display can be set up in a few minutes. It's composed by 1 aluminium frame structure, 1 header board, 2 sides wings, 3 shelves, 1 "V" table, 3 spotlights and 1 hard case. Pair this backdrop wall with some trade show fixtures available on this catalogue, such as counters, iPad mounts, chairs or brochure stands. The exhibition booths, offer a great way to market your business at trade shows, conventions, media events or expos.

OPOLE	QTY	N.W	G.W	C.B.M	SIZE
Packing	1	63.5kg	65kg	0.441	780x390x1450mm
10.192					

## EXTERNAL SIZE

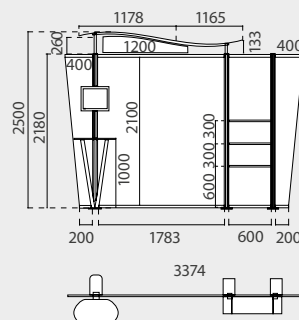

## ARTWORK

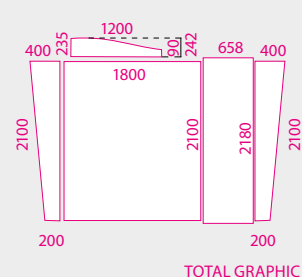

TOTAL GRAPHIC

\* TV is not included. Printing is available but not included.

# KASSEL



includes 3 spotlights



3 shelves included

hard case included



## INFORMATION

Kassel is a portable and elegant -All in one- trade show booth unit formed by a sturdy, 2824x2400mm aluminium structure. This unit can be easily assembled fast and easily. The entire portable display can be set up in a few minutes. It's composed by 1 aluminium frame structure, 1 header board, 3 shelves, 1 counter, 3 spotlights and 1 hard case. Pair this tradebooth with some trade show fixtures available on this catalogue, such as Totems, iPad mounts, chairs or brochure stands. The exhibition booths, offer a great way to market your business at trade shows, conventions, media events or expos.

KASSEL	QTY	N.W	G.W	C.B.M	SIZE
Packing	1	85.5kg	86.95kg	0.441	780x390x1450mm
10.364					

## EXTERNAL SIZE

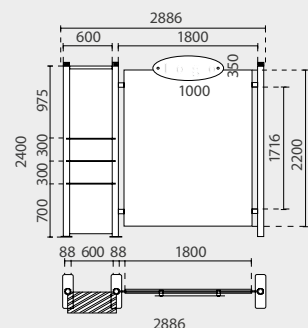

## ARTWORK

\*mm

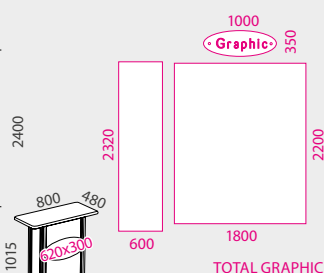

\* Printing is available but not included.



### CONTENT

EN

Flexible Pop-Up wall system. Easy assembly.  
 • Pop-Up 3x1: 3 units.  
 • Corner Accessories: 3 units.  
 • Plastic trolley Case: 2 units.

FR

Pop-Up magnétique facile à monter.  
 • Pop-Up 3x1: 3 unités.  
 • Accessoires pour les angles: 3 unités.  
 • Valise de transport en plastique: 2 unités.

PT

Pop-Up magnético de fácil montagem.  
 • Pop-Up 3x1: 3 unidades.  
 • Acessórios das esquinas: 3 unidades.  
 • Mala de transporte em plástico: 2 unidades.

ES

Sistema de Pop-Up flexible y de fácil montaje.  
 • Pop-Up 3x1: 3 unidades.  
 • Accesorios para esquinas: 3 unidades.  
 • 2 Maletas de plástico.

## PESCARA

2 trolley cases included



3 spaces divided to expose

### WALL DETAILS



### INFORMATION

Pescara is a flexible 3-walls booth graphics system made up of a Pop-up structure to create an impressive triple spaced trade show booth. With a top height of 2340mm, this event fixture features enough space for setting up counters, chairs or any display and create 3 conference environments for your business. Ideal for meeting one-on-one with potential customers at a trade show. Composed by a straight frame for 3 graphic sides and 3 corner accessories. The portable display breaks down quickly, fitting neatly into the 2 portable carrying bags (included) to transport back to your business or to the next event. The 2 trolley cases are made of heavy-duty molded plastic and features roller wheels, dual handles, and locking security.

### EXTERNAL SIZE & ARTWORK

\*mm

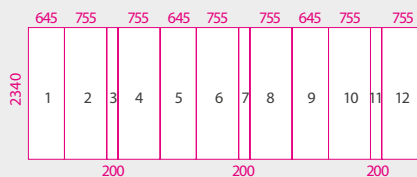
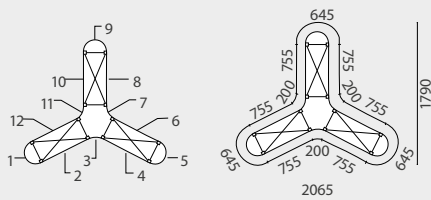

TOTAL GRAPHIC

PESCARA	QTY	N.W	G.W	C.B.M	SIZE
Packing	1	68.5kg	70kg	0.31	730x430x1010mm
				0.31	730x430x1010mm
10.639					

\* Printing is available but not included.

## CONTENT

EN

- Flexible Pop-Up wall system. Easy assemble.  
 • Pop-Up 3x3: 1 unit / Pop-Up 3x2: 2 units.  
 • Accessories corners: 3 units.  
 • Spotlights: 2 units. • Trolley Cases: 2 units.

FR

- Pop-Up magnétique facile à monter.  
 • Pop-Up 3x3: 1 unité. / Pop-Up 3x2: 2 unités.  
 • Foyer d'éclairage: 2 unités.  
 • Accessoires pour les angles: 3 unités.  
 • Valise de transport : 2 unités.

PT

- Pop-Up magnético de fácil montagem.  
 • Pop-Up 3x3: 1 unid. / Pop-Up 3x2: 2 unid.  
 • Focos: 2 unid. • Acessórios das esquinas: 3 unidades.  
 • Mala de transporte: 2 unidades.

ES

- Sistema de Pop-Up flexible y de fácil montaje.  
 • Pop-Up de 3x3: 1 unidad / Pop-Up 3x2: 2 unidades.  
 • 2 focos. • Accesorios para esquinas: 3 unidades.  
 • 2 Maletas tipo Trolley.

## FLORENCIA

2 spotlights are included

2 trolley cases included



## WALL DETAILS



## INFORMATION

Florencia is a flexible 3-walls booth graphics system made up of a Pop-up structure to create an impressive triple spaced trade show booth. With a top height of 2340mm, this event fixture features enough space for setting up counters, chairs or any display and create 2 conference environments for your business. Ideal for meeting one-on-one with potential customers at a trade show. Composed by a straight 3x3 frame, two 3x2 straight frames, 3 corner accessories and 2 spotlights. The portable display breaks down quickly, fitting neatly into the 2 portable carrying bags (included) to transport back to your business or to the next event. The 2 trolley cases are made of heavy-duty molded plastic and features roller wheels, dual handles, and locking security.

## EXTERNAL SIZE & ARTWORK

\*mm

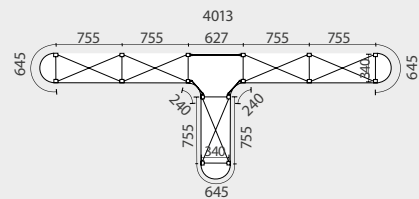

TOTAL GRAPHIC

FLORENCIA	QTY	N.W	G.W	C.B.M	SIZE
Packing	1	83kg	85.5kg	0.31	730x430x1010mm
				0.31	730x430x1010mm
<b>10.644</b>					

\* Printing is available but not included.

FLOOR SYSTEM DETAILS

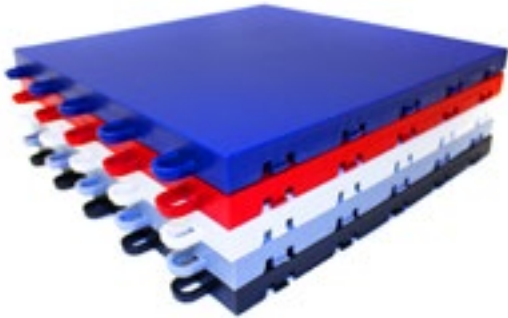

EXTERNAL SIZE

\*mm

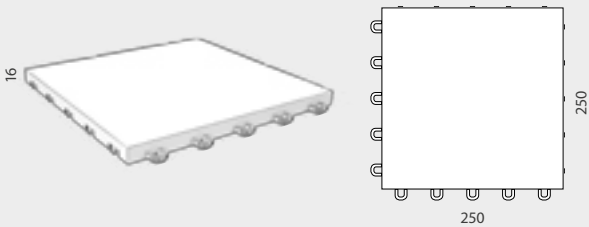

INFORMATION

Snap together these plastic interlocking floor tiles for an easy install and quick setup. Flooring made of high impact material results in long term use and dependability. Beneath each of the floor tiles there are ribbed support pillars for impact and shock absorption. Whether the 250x250mm configuration is used in a trade show booth exhibit, these multi-purpose floor tiles are suitable for indoor or outdoor events. Each unit with the reinforced composition provides a strong foundation efficient for impact and shock absorption. Ideal for a trade show booth set up. 5 colors available.

15.209



x16  (1m<sup>2</sup>)

TILE FOR FLOOR SYSTEM





## FLOOR SYTEM DETAILS

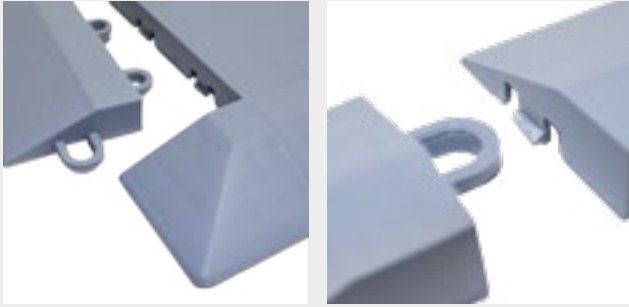

## FLOOR SYTEM DETAILS



## EXTERNAL SIZES

\*mm

Flooring construction is made easy with the clip and loop plastic tiles which allow each component to snap together without any tool. Create a finished and clean look by adding the sloped edge and mitered corner attachments to the perimeter for a smooth transition into a trade show booth. Each unit with the reinforced composition provides a strong foundation efficient for impact and shock absorption. Ideal for a trade show booth set up. 5 colors available.

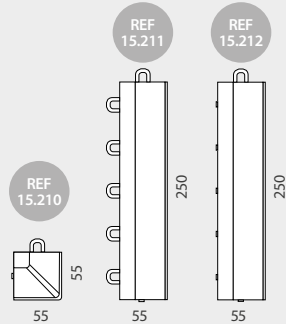

## FRAME FOR FLOOR SYSTEM

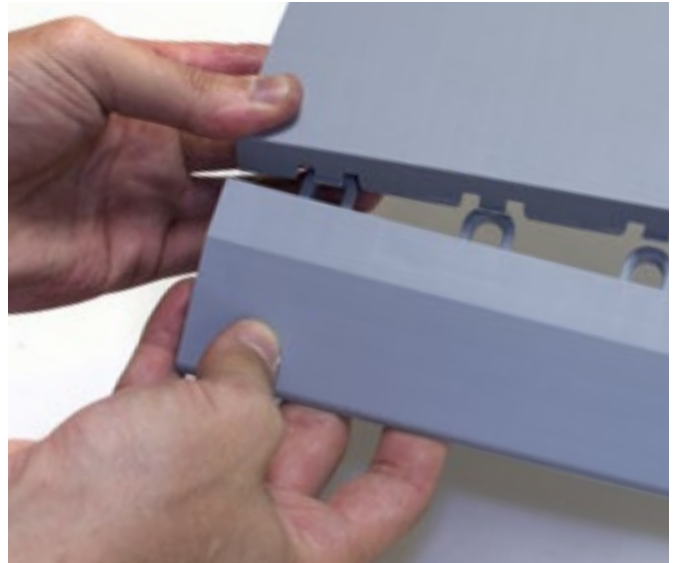

15.210		Corner x4
15.211		Frame Male x8
15.212		Frame Female x8

## QUICK SYSTEM



## TELESCOPIC POLE

aluminium pole system



1200 POLE	*mm	1500 POLE	*mm	2000 POLE	*mm
POLE 1		POLE 2		POLE 3	
10.961	Ø45x1200mm	10.962	Ø45x1500mm	10.963	Ø45x2000mm

### 7 WAYS CONNECTOR

**CONNECTOR** \*mm

Ø 40 / 45

49

7 WAYS CONNECTOR

10.968-40	Ø40mm
10.968-45	Ø45mm

### ALU BLOCK

**ALU BLOCK** \*mm

34

16

9

ALU BLOCK

10.969	x10
--------	-----

### RAIL

**INFORMATION** \*mm

- Combine it with:
- + pvc insert
- + end caps
- + connecting plate
- + side connecting block
- + back connecting block

RAIL

10.970	Length: 2 meters
--------	------------------

### POLE'S END CAPS

**CAP**

END CAPS

10.966	x10
--------	-----

### BASE CONNECTOR

\*mm

100

100

BASE CONN.

10.967		screw to the base
--------	--	-------------------

### SQUARE BASE

**SQUARE BASE** \*mm

380

380

SQUARE B.

10.964	380x380
--------	---------

### FEET BASE

**FEET BASE** \*mm

275

355

380

FEET BASE

10.965	
--------	--

## PVC INSERT

INFO \*mm

- Stick it to the PVC  
Adhesive

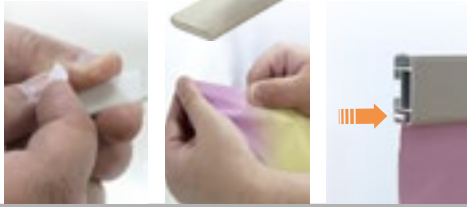

PVC INSERT

10.862 Length: 2 meter

## SIDE CONNECTING BLOCK

BLOCK \*mm

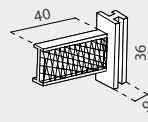

SIDE C.B.

10.863 x10 

## BACK CONNECTING BLOCK

INFO \*mm

- Rail connection.

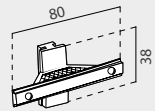

BACK C.B.

10.864 x10 

## END CAP

INFO \*mm

- Connect it to a rail.  
- Grey color finished.

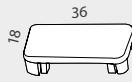

END CAP

10.971 x10 

## GRAPHIC CLIP

CLIP \*mm



G.CLIP

10.539 Ø45mm x10 

10.540 Ø40mm x10 

## WIRE CLIP

INFO \*mm

- Wires holder.

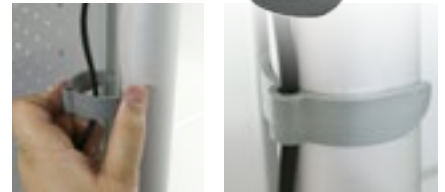

WIRE CLIP

10.541 Ø45mm x10 



10.542 Ø40mm x10 

INFO \*mm

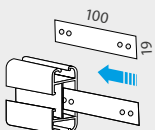
- 19mm width.  
- Front connection.



C.PLATE 19

10.972 x10  100x19mm 



## CONNECTING PLATE

INFO \*mm

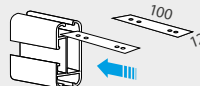
- 12mm width.  
- Sideway connection.



C.PLATE 12

10.973 x10  100x12mm 

## PLASTIC CLIP

### INFO

- Plastic.
- Ideal for holding poster or banner.



PLASTIC CLIP

10.537

x10 

## SIDE CLIP

### INFO

- Plastic.



SIDE CLIP

10.538

x10 

## ARC SHELF

### INFO

- Includes 2 Alu Block.

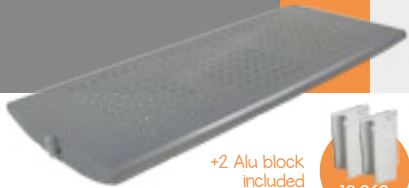

+2 Alu block included



10.959

828x350mm

## SHELF

### INFO

- Includes 4 Alu Block.



+4 Alu block included



10.960

825x400mm

## LCD BRACKET

### INFO

- Plastic.
- Includes 1 Alu Block.



+1 Alu block included



10.543



## PANEL

### INFO

- Metallic.
- Perforated.
- Includes 4 Alu Block.



+4 Alu block included



10.958

825x1000mm

all brochures holders include Alu Block



### INFO

- Includes 1 Alu Block.
- For A4 size documents.

BROCH. A4

10.544

A4

### INFO

- Includes 1 Alu Block.
- For A5 size documents.

BROCH. A5

10.545

A5

## ACRILYC BROCHURE HOLDER



### INFO

- Includes 1 Alu Block.
- For A6 size documents.

BROCH. A6

10.546

A6



### INFO

- With connecting base. Ideal for illuminating your exhibit booth and shed light on your products.



SPOTLIGHT

10.389

475x138mm

## SPOTLIGHT



## PROFILE STAND 100mm

### INFORMATION

Aluminum profile for the assembly of exhibition stands.  
Profile dimensions: 100x100mm.

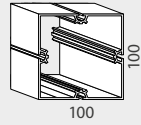

\*mm

15.116                      100mm

## PROFILE STAND 40mm

### INFORMATION

Aluminum profile for the assembly of exhibition stands.  
Profile dimensions: 40x40mm.



\*mm

15.118                      40mm

## ALUMINIUM CONNECTOR FOR PROFILE 100mm

### INFORMATION

- 1. Place the connector.
- 2. Adjust the connector into the aluminium profile.

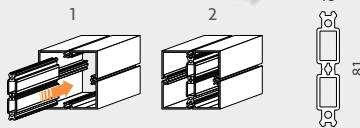

\*mm

15.117                      Connector 100mm

## LOCK

### INFORMATION

Use 1 lock for 40mm profile and 2 locks for 100mm profile.

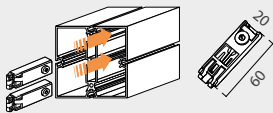

\*mm

LOCK                      2 Lock for 100mm                      1 lock for 40mm

15.119                      x2 

## PLASTIC PIECES FOR TENSION GRAPHICS

### INFORMATION

Use these tension plastic fasteners with springs for attaching your canvas to the profile stand system.



\*mm

15.723                      x 10 

## PROFILE STAND



## INFORMATION

- EN Holding system for glass or acrylic performing stand. Suitable for being used with 100mm aluminium profile. Material: Steel.
- FR Système de fixation modulable pour vitres ou acryliques permettant le montage de stands. S'utilise avec un profil stand de 100mm.
- PT Sistema de fixação de vidros ou acrílicos para a montagem de stands. Utiliza-se com um perfil de 100mm. Material: Aço.
- ES Sistema de fijación de cristales o acrílicos para la realización de stand. Se utiliza con el profile stand de 100mm. Material: Acero.

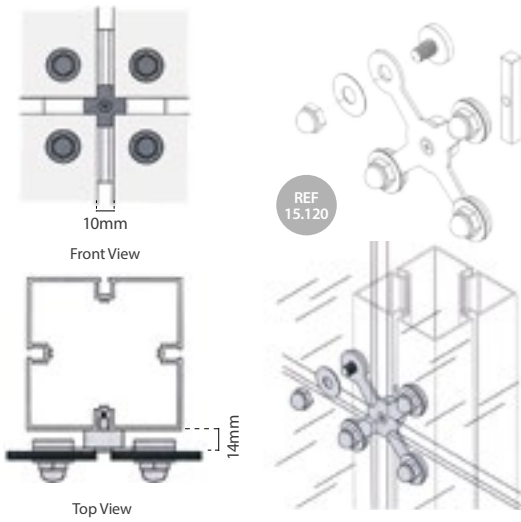

## GLASS WALL



## INFORMATION

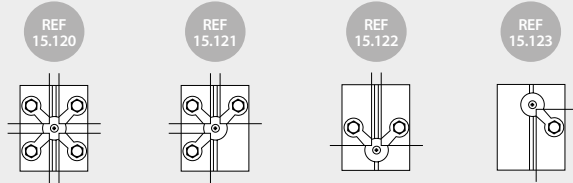

## HOLES TEMPLATE

\*mm

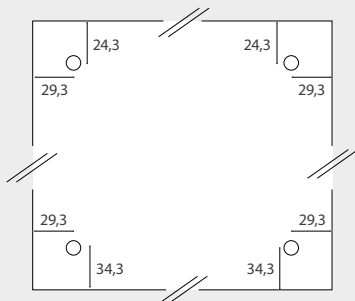

Dimensions for holes on glass or acrylic. / Dimensions pour le cristal ou l'acrylique. Medidas para furos em vidro ou acrílico. / Medidas para agujeros en cristal o acrílico.

GLASS WALL	PARTS
15.120	4 Parts
15.121	3 Parts
15.122	2 Parts
15.123	1 Part



TRUSS DETAILS



light weight  
and high  
strength



STANDARD SIZES

\*mm

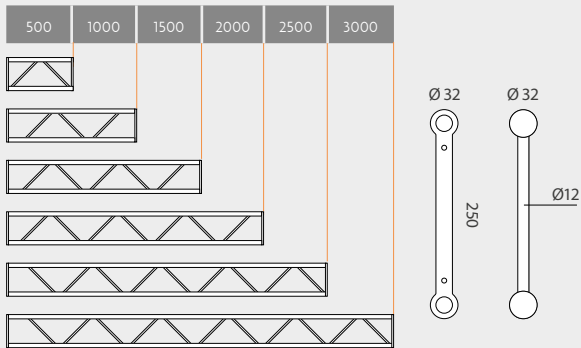

INFORMATION

Aluminium Truss "Duo" formed by 2 aluminum bars, color "natural silver."

TRUSS DUO	SIZE
15.305	500mm
15.060	1000mm
15.063	1500mm
15.066	2000mm
15.306	2500mm
15.307	3000mm

ALUMINIUM  
TRUSS "DUO"

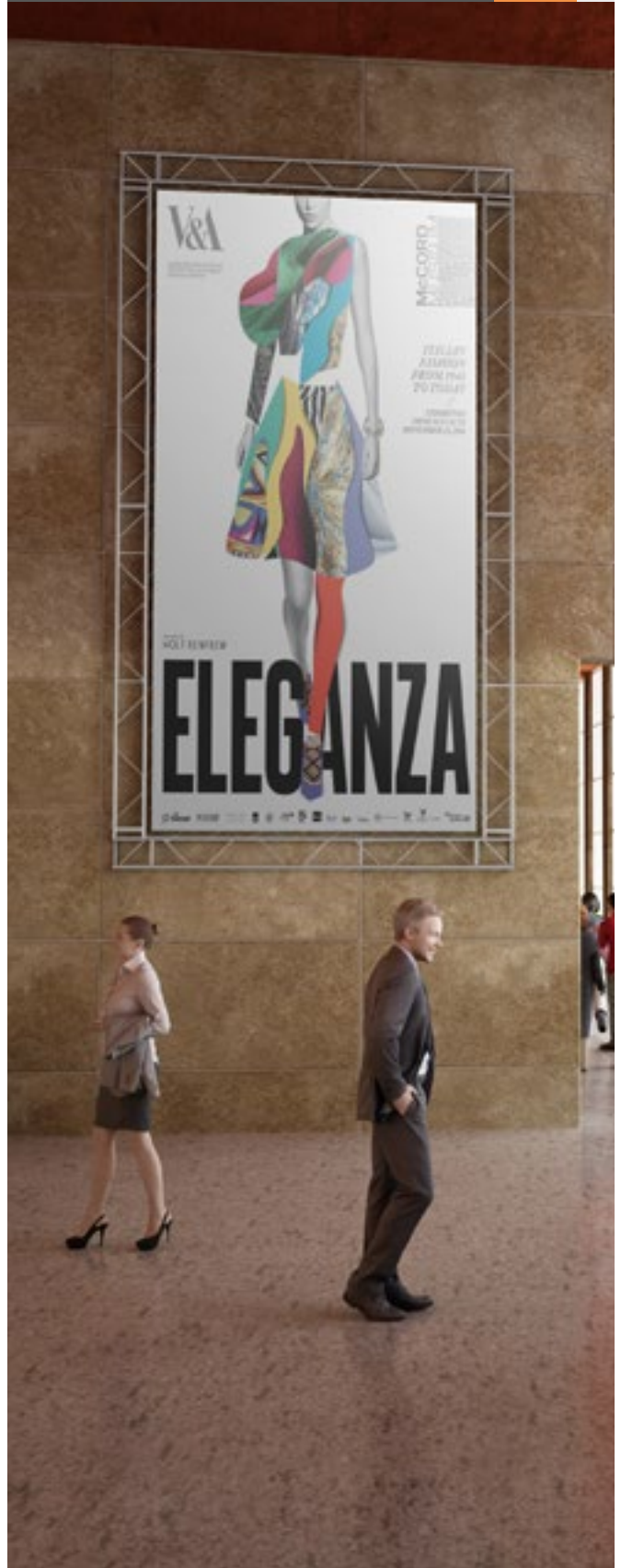







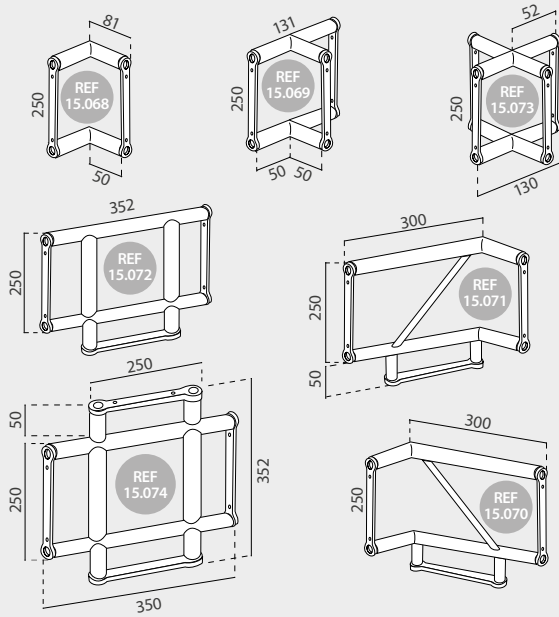

## STANDARD SIZES

\*mm



## STANDARD SIZES

CONNECTOR	SIZE	
15.068	2 connection sides	
15.069	3 connection sides	
15.070	3 connection sides	
15.071	3 connection sides	
15.072	3 connection sides	
15.073	4 connection sides	
15.074	4 connection sides	

## ALUMINIUM TRUSS "DUO" CONNECTOR

### TRUSS DETAILS



light weight  
and highly  
resistant



## INSTALL EXPLANATION

\*mm

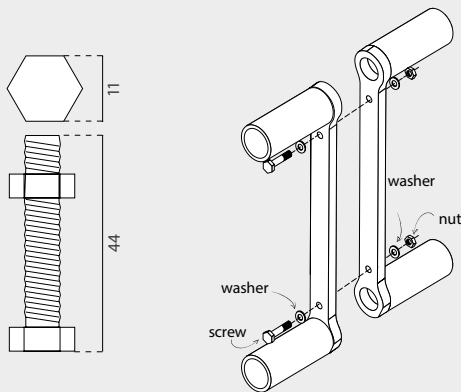

## INFORMATION

These screws for mounting the aluminum Truss are made of steel. Nut is supplied.

S CREWS T.	SIZE
15.040	44x11mm

## STEEL SCREWS FOR ALUMINIUM TRUSS





## INFORMATION

EN	Vertical aluminium Truss, 32 mm diameter. Ideal for producing and assembling a booth, venues, outdoor events, placing graphics, etc. It is characterized by its great resistance, lightweight and easy assembly. Color: natural silver.
FR	Colonne de Truss fabriquée en aluminium, couleur "argent naturel" avec tubes de 32mm de diamètre. Idéal pour la réalisation et le montage de stands, scènes, événements extérieurs, suspension de bâches, etc. Léger, résistant et facile à monter.
PT	Colunas Truss fabricadas em alumínio, em cor prateada, com tubos de 32mm de diâmetro. Ideal para a realização e montagem de stands, cenários, eventos ao ar livre, colocação de lonas, entre outros. Caracteriza-se pela sua grande resistência, leveza e fácil montagem.
ES	Largueros Truss, fabricados en aluminio, color "plata natural", con tubos de 32mm de diámetro. Ideal para realización y montaje de stands, escenarios, eventos al aire libre, colocación de lonas, etc. De gran resistencia, peso ligero y fácil montaje.

## ALUMINIUM TRUSS "SHOW"

light weight and resistant



with accessories



"SHOW"	SIZE	500	750	1000	1500	2000	2500	3000
15.301	500x250mm							
15.302	750x250mm							
15.141	1000x250mm							
15.143	1500x250mm							
15.145	2000x250mm							
15.303	2500x250mm							
15.304	3000x250mm							

MAIN TUBES	Ø32x1.2mm
BRACES	Ø12x1.0mm
MATERIAL	Alloy En-Aw 6005 T6
WEIGHT	1.84 kg/m

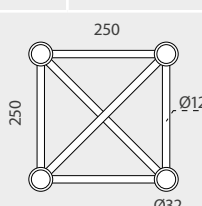

## INFORMATION

EN	Connectors for joining Truss spars. Produced in aluminum and with "natural silver" finish.
FR	Cube pour l'union de colonnes de Truss. Fabriqué en aluminium est de couleur "argent naturel".
PT	Cubos de união para colunas Truss fabricados em alumínio de cor prateada.
ES	Cubos para unión de largueros de Truss. Fabricados en aluminio con acabado "plata natural".



CONNECTOR T.	SIZE
15.147	250x250x250mm

## CONNECTOR TRUSS



**CONICAL CONNECTOR**



**INFO**

Conical connector for joining Truss bars.

15.148

**HALF CONICAL CONNECTOR**



**INFO**

Conical semiconnector for joining Truss bars + bolt.

15.151

**PIN**



**INFO**

Pin for the connection of Truss bars

15.149

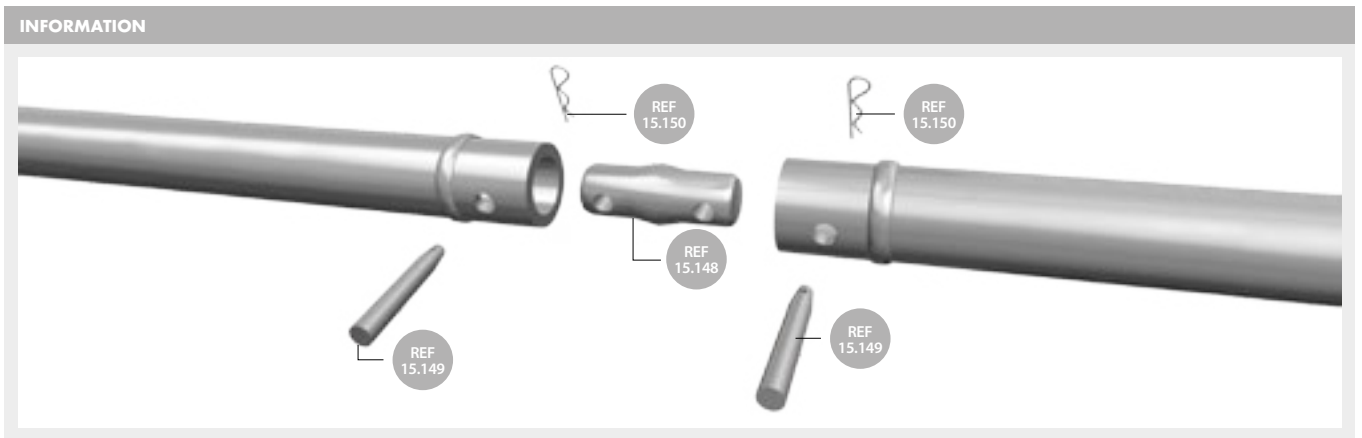

**SAFETY CLIP**



**INFO**

Clip to secure the connection of Truss bars

15.150

**BASE FOR ALUMINIUM TRUSS "SHOW"**



**INFO**

Steel base for aluminium Truss "Show".

15.300    300x300mm

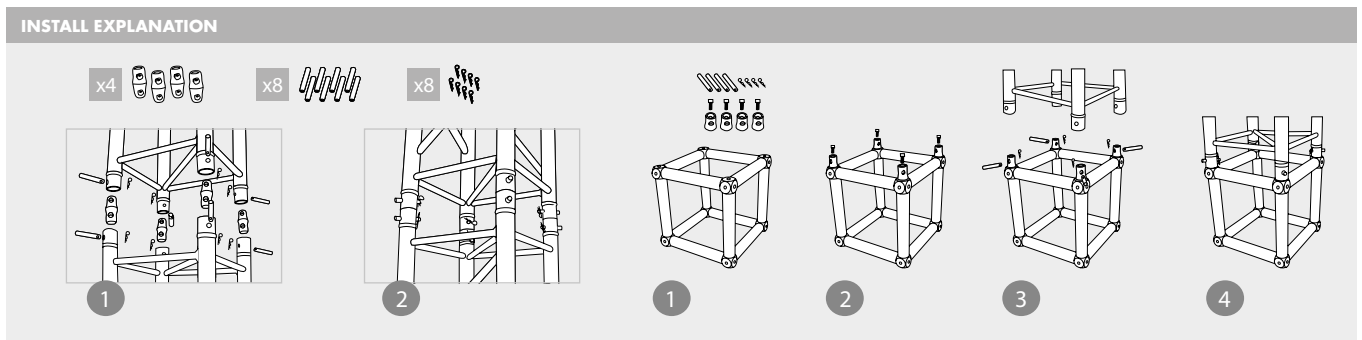

## CAMIN



### STOOL DETAILS



### INFORMATION

The Camin Bar Stool features a adjustable 850mm max height and it is made of Polypropylene plastic with chromed finished structure. 2 colors available.

CAMIN	QTY	N.W	G.W	C.B.M	SIZE
Packing	1	10.7kg	11.07kg	0.052	460x300x420mm
31.284	<input type="checkbox"/>	380x850x380mm			640-850mm
	<input type="checkbox"/>				

## MONET



### STOOL DETAILS



### INFORMATION

The Monet Bar Stool features a pressure lever for an optimal height adjustment. With seat made of ABS plastic and chromed finished structure.

MONET	QTY	N.W	G.W	C.B.M	SIZE
Packing	2	13.8kg	14.6kg	0.088	420x410x515mm
31.033	<input checked="" type="checkbox"/>	350x940x420mm			730-940mm

### STOOL DETAILS



### INFORMATION

The Tiepolo Bar Stool features a pressure lever for getting an optimal height adjustment. With seat made of ABS plastic and chromed finished structure.

TIEPOLO	QTY	N.W	G.W	C.B.M	SIZE
Packing	2	13.5kg	14.3kg	0.170	570x490x610mm
31.043	<input type="checkbox"/>	470x960x470mm			750-960mm
31.044	<input checked="" type="checkbox"/>				
31.045	<input checked="" type="checkbox"/>				

## TIEPOLO



### CHAIR DETAILS



## MISTRAL



### CHAIR DETAILS



### INFORMATION

The Mistral Chair features a 800mm height with a seat made of Polypropylene plastic with a chromed finished four-legged structure. 2 colors available.

MISTRAL	QTY	N.W	G.W	C.B.M	SIZE
Packing	1	16.6kg	18.2kg	0.123	570x570x540mm
31.281	<input type="checkbox"/>	575x800x525mm			800mm
	<input type="checkbox"/>				

## BORGES



### CHAIR DETAILS



### INFORMATION

The Borges Chair features a 765mm height with a back and seat made of Polypropylene. And it has a four-legged beech frame. 2 colors available.

BORGES	QTY	N.W	G.W	C.B.M	SIZE
Packing	1	4.1kg	5.2kg	0.1238	780x560x170mm
31.280	<input type="checkbox"/>	420x765x480mm			765mm
	<input type="checkbox"/>				

## MARTI



### STOOL DETAILS



### INFORMATION

The Marti Stool features a 865mm height with a seat made of Polypropylene plastic with a chromed finished four-legged structure. 2 colors available.

MARTI	QTY	N.W	G.W	C.B.M	SIZE
Packing	1	22.5kg	23.6kg	0.23	570x460x850mm
31.283	<input type="checkbox"/>	410x865x400mm			865mm
	<input type="checkbox"/>				

## DELMAR



### STOOL DETAILS



### INFORMATION

The Delmar Stool features a 865mm height with a seat made of Polypropylene plastic. And it has a four-legged wooden structure. 2 colors available.

DELMAR	QTY	N.W	G.W	C.B.M	SIZE
Packing	1	4.6kg	5.9kg	0.064	780x450x200mm
31.282	<input type="checkbox"/>	390x865x440mm			865mm
	<input type="checkbox"/>				

TABLE DETAILS



INFORMATION

The Rubens Bar Table features a Ø600mm top surface made of ABS plastic with a stable chromed finished structure. With 2 colors available.

RUBENS	QTY	N.W	G.W	C.B.M	SIZE
Packing	1	7.3kg	8.1kg	0.108	620x200x620mm 180x180x990mm
31.037	<input type="checkbox"/>	Ø600x1090mm			
31.038	<input type="checkbox"/>				

RUBENS



TABLE DETAILS



TABLE DETAILS



INFORMATION

The Frost Bar Table features a Ø600mm top surface made of ABS plastic with a stable chromed finished structure. With 2 colors available.

FROST	QTY	N.W	G.W	C.B.M	SIZE
Packing	1	6.5kg	7.8kg	0.077	620x200x620mm
31.286	<input type="checkbox"/>	Ø600x735mm			
	<input type="checkbox"/>				

FROST



TABLE DETAILS



BANNER DETAILS



DIMENSIONS AND KIT CONTENT

\*mm

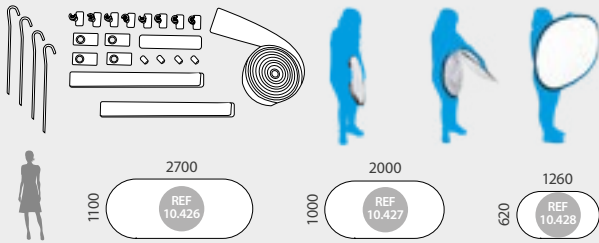

INFORMATION

This outdoor foldable banner is extremely portable and lightweight. Its flexible fiberglass providing greater stability. Carry bag, hooks, pole connectors and 60mm width fabric trape are included. Ideal for making your message stand out from the crowd at any event either indoors or outdoor.

SILVES 620	QTY	N.W	G.W	C.B.M	SIZE
Packing	5	7kg	7.25kg	0.08	660x180x660mm
Uni.	1	1.40kg	1.45kg	0.012	640x30x640mm
<b>10.428</b>	<b>Graphic Size: 620x1260mm</b>				

SILVES 1000	QTY	N.W	G.W	C.B.M	SIZE
Packing	5	8.50kg	8.9kg	0.17	960x180x960mm
Uni.	1	0.90kg	1kg	0.045	950x50x950mm
<b>10.427</b>	<b>Graphic Size: 1000x2000mm</b>				

SILVES 1100	QTY	N.W	G.W	C.B.M	SIZE
Packing	5	12.50kg	13kg	0.26	1200x180x1200mm
Uni.	1	2.50kg	2.60kg	0.05	1140x30x1140mm
<b>10.426</b>	<b>Graphic Size: 1100x2700mm</b>				

SILVES  
GOLF BANNER



\* Printing is available but not included.

# YUSTE

4.5m

## BANNER DETAIL



## ARTWORK \*mm

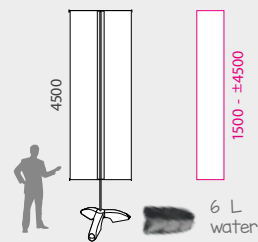

## INFORMATION

Yuste is a telescopic flagpole with a refillable 6l base. It can be used with 2 flag banners (1-sided or 2-sided option). It is made of aluminium and plastic. Carry bag is included.



YUSTE	QTY	N.W	G.W	C.B.M	SIZE
Pole	1	1.35kg	1.85kg	0.015	120x80x1650mm
Base	1	0.95kg	1.15kg	0.017	260x200x340mm
10.709	Graphic Size: ± 600x1500-4500mm (x2)				

# BREST

4.1m

## BANNER DETAIL

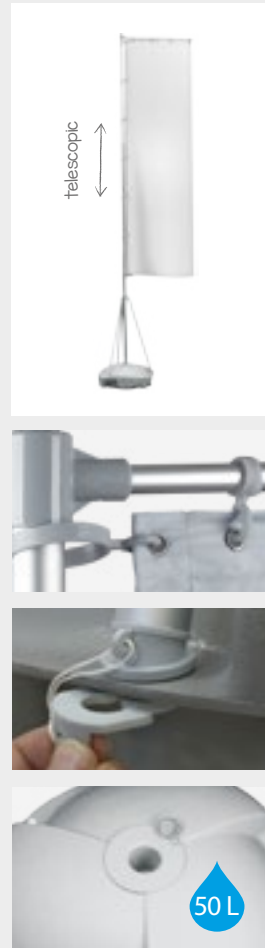

## ARTWORK \*mm

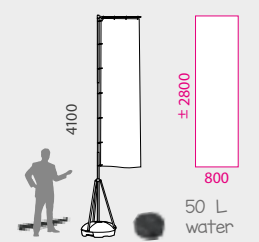

## INFORMATION

Brest is a telescopic flagpole with a refillable 50l base. Its feet structure is foldable for an improved storing. It is made of aluminium and plastic. Carry bag is included.



BREST	QTY	N.W	G.W	C.B.M	SIZE
Pole	1	4.1kg	5.1kg	0.029	135x135x1610mm
Base	1	6kg	6.3kg	0.117	665x265x665mm
10.652	Graphic Size: ± 800x2800mm				

\* Printing is available but not included.



BANNER DETAILS

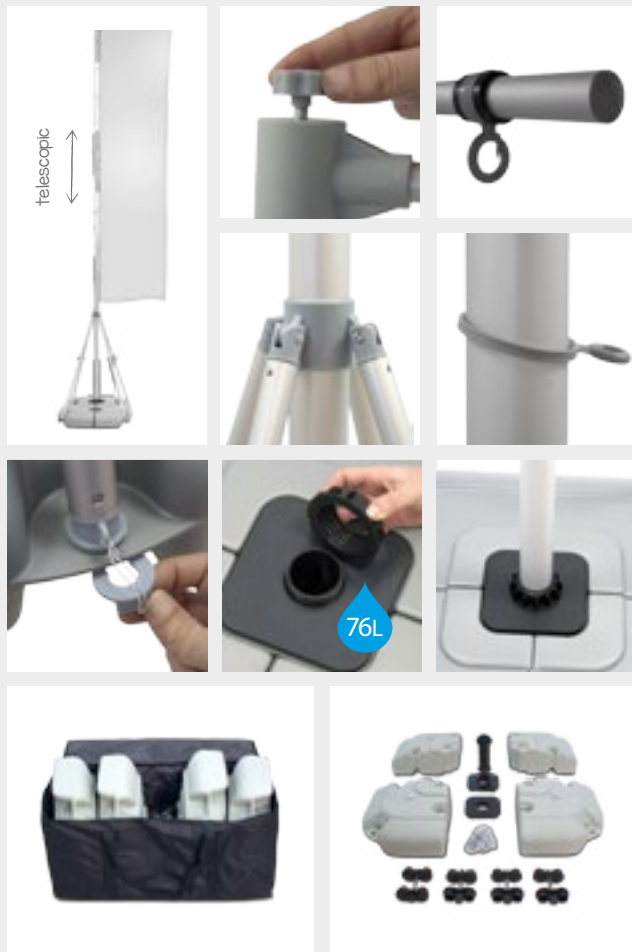

DIMENSIONS

ARTWORK \*mm

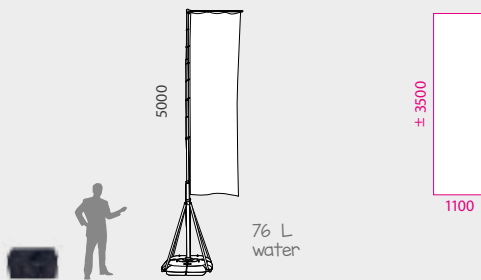

INFORMATION

The Bejar is a telescopic flagpole with a refillable 76l plastic base. Its feet structure is foldable and its base is 4-pieces removable for an improved storing. Brest flagpole is made of aluminium and plastic parts. A carry nylon bag is included for a better transportation. Ideal for being used at outdoor events, tradeshow exposition entrances for displaying to large distances.

BEJAR	QTY	N.W	G.W	C.B.M	SIZE
Pole	1	7.5kg	9.8kg	0.04	160x130x1680mm
Base	1	10kg	11kg	0.14	430x380x850mm
10.031	Graphic Size: 1100x3500mm				

BEJAR

5m



\* Printing is available but not included.

### BANNER DETAILS

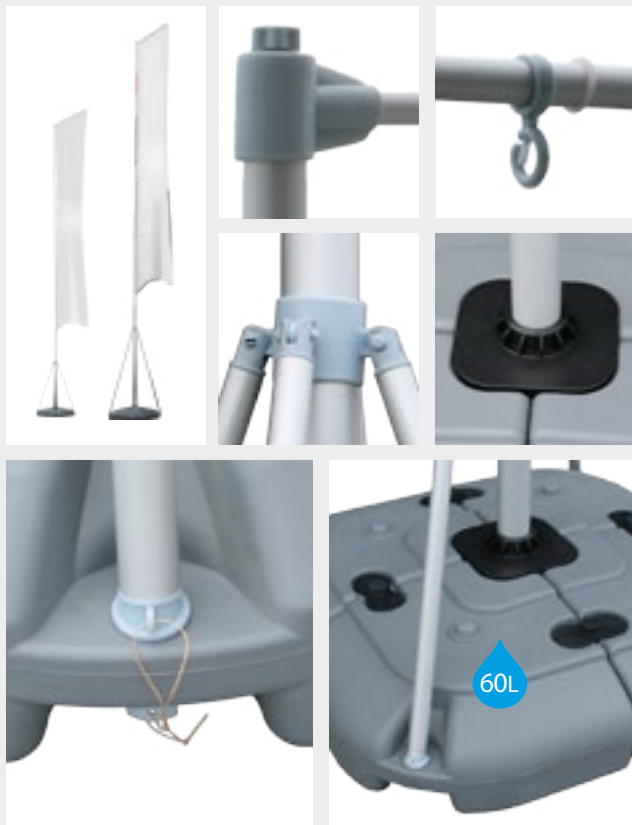

### DIMENSIONS

### ARTWORK \*mm

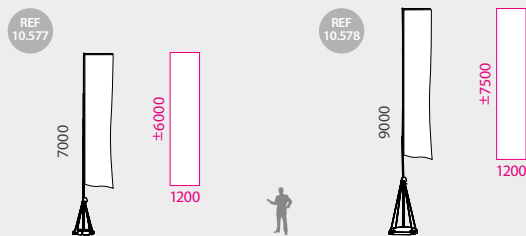

### INFORMATION

The Bejar is a telescopic flagpole with a refillable 60 l plastic base. Its feet structure is foldable and its base is 4-pieces removable for an improved storing. Bejar flagpole is made of aluminium and plastic parts. A carry nylon bag is included for a better transportation. With the biggest heights available, they are ideal for being used at outdoor events, tradeshows exposition entrances.

CERGY 6000	QTY	N.W	G.W	C.B.M	SIZE
Pole	1	6.5kg	7.5kg	0.03	150x130x1710mm
Base	1	8kg	9kg	0.13	410x410x805mm

10.577 Graphic Size:  $\pm$  1200x6000mm

CERGY 7500	QTY	N.W	G.W	C.B.M	SIZE
Pole	1	8.5kg	9.5kg	0.05	180x170x1710mm
Base	1	14kg	15kg	0.24	510x510x920mm

10.578 Graphic Size:  $\pm$  1200x7500mm

## CERGY

9-7m



\* Printing is available but not included.

BANNER DETAILS

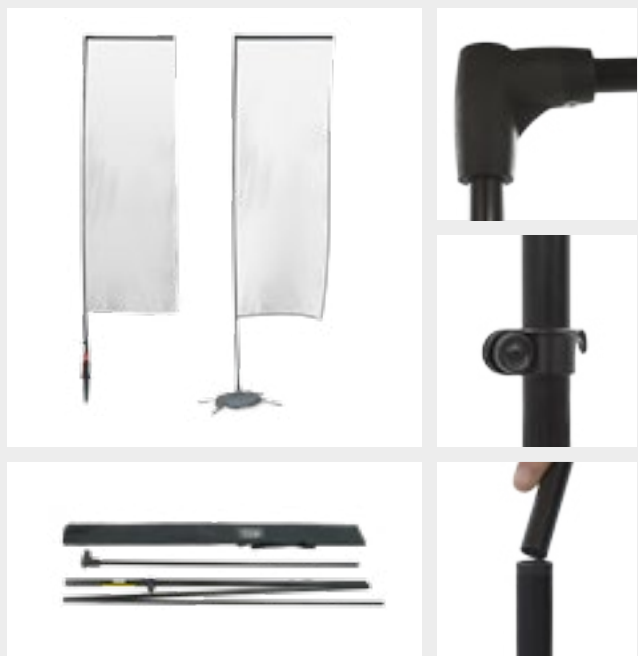

ARTWORK

\*mm

SAFE ZONE  
TOTAL GRAPHIC

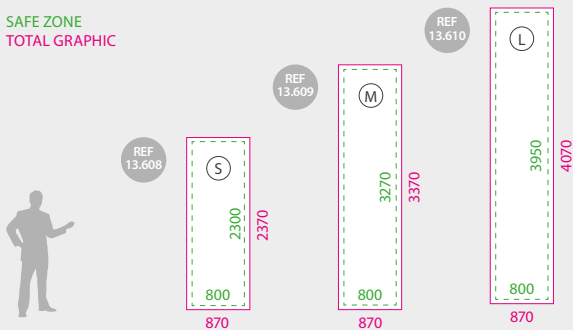

INFORMATION

ACCESSORIES AVAILABLE

Square flagpole is usually used for promoting on beaches. Its lightweight pole set-up and down in seconds for an improved storing. Carry bag included. Several accessories available later at this chapter. Textile manufacturing available (not included). You can choose black or white colour of pole sheath.

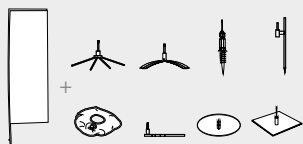

SQUARE S	QTY	N.W	G.W	C.B.M	SIZE
Packing	1	0.94kg	1.44kg	0.004	80x50x1050mm
13.608				(S)	
SQUARE M	QTY	N.W	G.W	C.B.M	SIZE
Packing	1	1.46kg	1.96kg	0.005	100x50x1050mm
13.609				(M)	
SQUARE L	QTY	N.W	G.W	C.B.M	SIZE
Packing	1	1.80kg	2.30kg	0.005	100x50x1050mm
13.610				(L)	

SQUARE



\* Printing, bases and accessories are available but not included. The price includes only the flagpole.

## BANNER DETAILS



## ARTWORK

\*mm

SAFE ZONE  
TOTAL GRAPHIC

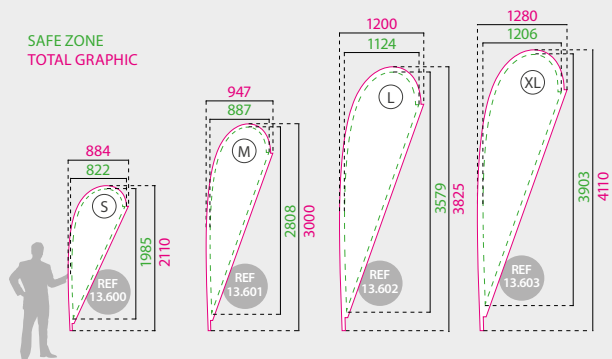

## INFORMATION

The Spoon is a flagpole made of fiberglass, aluminium and plastic. The pole is collapsible for an easy portability. Also, a carry nylon bag is included. Multiple accessories are available later at this chapter. Textile manufacturing available (not included). You can choose black or white colour of pole sheath.

## ACCESSORIES AVAILABLE

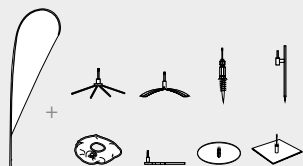

SPOON S	QTY	N.W	G.W	C.B.M	SIZE
Packing	1	0.67kg	0.72kg	0.004	65x50x1410mm
13.600				(S)	
SPOON M	QTY	N.W	G.W	C.B.M	SIZE
Packing	1	1.07kg	1.57kg	0.005	80x50x1410mm
13.601				(M)	
SPOON L	QTY	N.W	G.W	C.B.M	SIZE
Packing	1	1.49kg	1.99kg	0.005	80x50x1410mm
13.602				(L)	
SPOON XL	QTY	N.W	G.W	C.B.M	SIZE
Packing	1	1.78kg	2.28kg	0.005	80x50x1410mm
13.603				(XL)	

## SPOON



\* Printing, bases and accessories are available but not included. The price includes only the flagpole.

BANNER DETAILS



ARTWORK

\*mm

SAFE ZONE  
TOTAL GRAPHIC

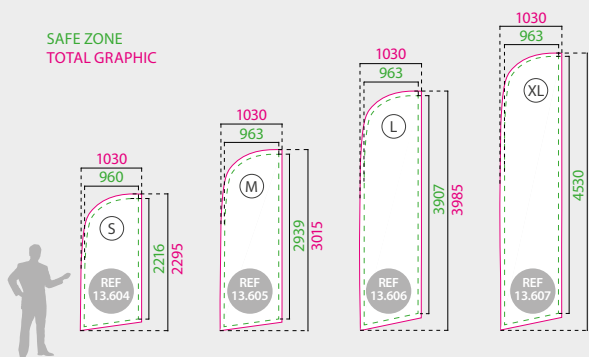

INFORMATION

ACCESSORIES AVAILABLE

The Knife is a flagpole made of fiberglass, aluminium and plastic. The pole is collapsible for an easy portability. Also, a carry nylon bag is included. Multiple accessories are available later at this chapter. Textile manufacturing available (not included). You can choose black or white colour of pole sheath.

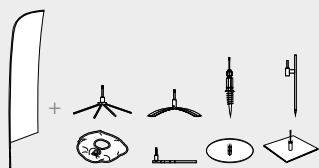

KNIFE S	QTY	N.W	G.W	C.B.M	SIZE
Packing	1	0.94kg	1.44kg	0.005	80x50x1410mm
13.604				(S)	
KNIFE M	QTY	N.W	G.W	C.B.M	SIZE
Packing	1	1.15kg	1.65kg	0.005	80x50x1410mm
13.605				(M)	
KNIFE L	QTY	N.W	G.W	C.B.M	SIZE
Packing	1	1.60kg	2.10kg	0.005	80x50x1410mm
13.606				(L)	
KNIFE XL	QTY	N.W	G.W	C.B.M	SIZE
Packing	1	1.65kg	2.15kg	0.006	90x50x1410mm
13.607				(XL)	

KNIFE



\* Printing, bases and accessories are available but not included. The price includes only the flagpole.

# OUTDOOR EVENTS Flag Banner Accessories



## CROSS BASE WITH WATER PLASTIC BAG

3 L bag included



### INFORMATION \*mm

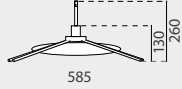

- With 3l refillable bag.
- Ideal for using with the larger flags, also can be used on uneven ground (even on slopes).

CROSS BASE	QTY	N.W	G.W	C.B.M	SIZE
Packing	40	28kg	31kg	0.115	620x460x720mm
Uni.	1	0.7kg	0.77kg	0.025	350x110x590mm
<b>13.611</b>					

## TIRE BASE U STYLE



### INFORMATION \*mm

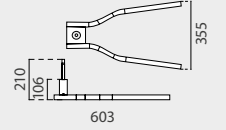

- Fast to assemble.
- Ideal for installation under car wheel thanks its U shape.

U STYLE	QTY	N.W	G.W	C.B.M	SIZE
Packing	20	34kg	37kg	0.138	540x400x640mm
Uni.	1	1.7kg	1.85kg	0.028	380x120x620mm
<b>13.614</b>					

## WATER PLASTIC BAG



3 L water

### INFORMATION



- Great stability.
- Fast to assemble.
- Add an extra 3l weight.
- Suitable for Cross-Plate, Round and Square bases.

W.P.BAG	QTY	N.W	G.W	C.B.M	SIZE
Packing	20	3kg	4kg	0.006	200x150x200mm
Uni.	1	0.15kg	0.2kg	0.009	140x40x160mm
<b>10.766</b>					

## ROUND PLATE BASE



### INFORMATION \*mm

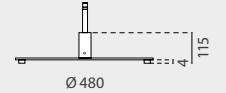

- Great stability.
- Fast to assemble.
- Recommended for an outdoor or indoor use with all Flying Banners.

ROUND	QTY	N.W	G.W	C.B.M	SIZE
Packing	1	8kg	8.5kg	0.014	530x45x590mm
<b>13.615</b>					

## GROUND DRILL



### INFORMATION \*mm

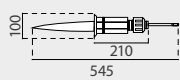

- Fast to assemble.
- For soft grounds, sand or snow. Ideal for displaying at the beach in summer or ski slopes in winter.

DRILL	QTY	N.W	G.W	C.B.M	SIZE
Packing	20	12kg	15kg	0.115	460x410x610mm
Uni.	1	0.6kg	0.75kg	0.025	390x110x590mm
<b>13.612</b>					

## SQUARE PLATE BASE



### INFORMATION \*mm

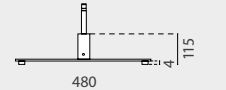

- Great stability.
- Fast to assemble.
- Recommended for an outdoor or indoor use with all Flying Banners.

SQUARE	QTY	N.W	G.W	C.B.M	SIZE
Packing	1	6kg	6.5kg	0.014	530x45x590mm
<b>13.616</b>					

## ROUND STRAIGHT SPIKE

ideal for grass or soft grounds



### INFORMATION \*mm

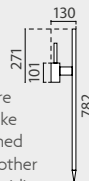

- Fast assembly.
- By the own nature of the ground spike being driven pushed into the grass or other soft grounds, providing a very stable platform.

SPIKE	QTY	N.W	G.W	C.B.M	SIZE
Packing	20	30kg	33kg	0.061	300x225x610mm
Uni.	1	1.5kg	1.65kg	0.009	55x40x590mm
<b>13.613</b>					

## CROSS PLATE BASE

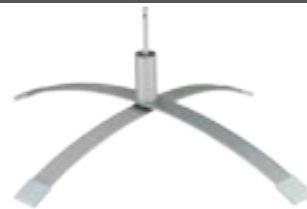

### INFORMATION \*mm

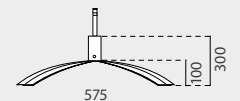

- Great stability.
- Fast to assemble.
- Ideal for concrete surfaces, footpaths or also, for indoor use.

CROSS	QTY	N.W	G.W	C.B.M	SIZE
Packing	5	21.5kg	24kg	0.030	320x120x800mm
Uni.	1	4.3kg	4.8kg	0.005	110x60x780mm
<b>13.617</b>					

BACKPACK DETAILS



BACKPACK BANNER



INFORMATION

DIMENSIONS \*mm

Comfortable backpack banner for street marketing. 3 banner holding systems available. Featuring fiberglass structure, side and top pockets, shoulder/waist buckles, soft padded for back and telescopic poles or flag tensor depending on model.

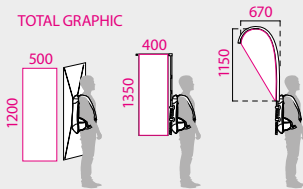

X-BANNER	QTY	N.W	G.W	C.B.M	SIZE
Packing	1	1.1kg	1.25kg	0.03	650x100x400mm
<b>10.760</b>	<b>Graphic Size: 500x1200mm</b>				
FLAG BANNER	QTY	N.W	G.W	C.B.M	SIZE
Packing	1	1.1kg	1.25kg	0.03	650x100x400mm
<b>10.794</b>	<b>Graphic Size: 400x1350mm</b>				
TEARDROP BANNER	QTY	N.W	G.W	C.B.M	SIZE
Packing	1	1.2kg	1.35kg	0.03	650x100x400mm
<b>10.795</b>	<b>Graphic Size: 670x1150mm</b>				

### STANDARD FLAG FINISHES

### FASTENING

### FLAG SEWING

#### BASIC SEWING



No fastening



Material: Made of Polyester 117g. Flag with basic sewing without fastening.

1

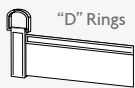

"D" Rings



Material: Made of polyester 117g. Includes three-sided perimeter folding and reinforcement on one side. With two "D" rings for fastening.

2

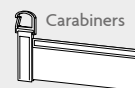

Carabiners



Material: Made of Polyester 117g. Includes three-sided perimeter folding and reinforcement on one side. With two plastic carabiners for fastening.

3

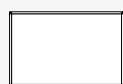

Eyelets



Material: Made of Polyester 117g. Includes three-sided perimeter folding and reinforcement on one side. With two eyelets for fastening.

4

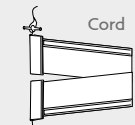
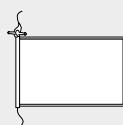

Cord

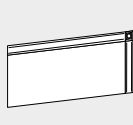

Material: Made of Polyester 117g. Includes three-sided perimeter folding and reinforcement on one side. With not elastic cord for fastening.

5

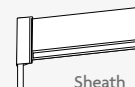
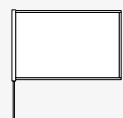

Sheath



Material: Polyester 117g. Includes 3-sided perimeter folding with Ø 20mm sheath.

6

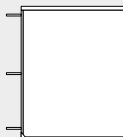

genuine  
VELCRO®  
brand  
straps  
or Cord



Material: Polyester 117g. Includes three-sided perimeter folding and one side reinforced. With genuine VELCRO® brand straps or cord for fastening.

7

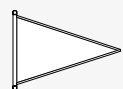

Rings / Carabiners

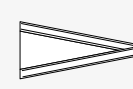

Material: Polyester 117g. Includes three-sided perimeter folding and reinforcement on one side. With rings type "D" or carabiners for fastening.

FLAGS	SIZE	BASIC SEWING	1	2	4	5	7	3	6
10.379	700x1000mm								
10.882	1500x1000mm								
10.883	2000x1200mm								
10.884	2500x1500mm								

## STANDAR FLAGS SYSTEM





# OUTDOOR EVENTS Standard Flag System



C.E



Spain



France



Portugal



Germany



United Kingdom



Sweden



Austria



Belgium



Bulgaria



Cyprus



Czech Republic



Denmark

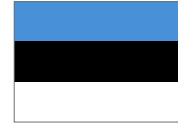

Estonia



Ireland



Italy



Latvia



Lithuania



Luxembourg



Malta



Finland



Romania



Slovakia



Slovenia



Poland



Greece



Hungary



Netherlands



Afghanistan



Albania



Algeria



Andorra



Argentina



Armenia



Australia



Barbados



Brazil



Cameroon



Canada



Chile



Colombia



Cuba



Ecuador



Egypt



Ethiopia



Guatemala



Haiti



Jamaica

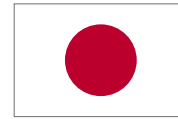

Japan



Mexico



Panama



Qatar



Russia



Switzerland



Ukraine



United Arab Emirates



United States



Uruguay



Uzbekistan



Venezuela



Vietnam



Yemen



Zambia

## Internationals



Unicef

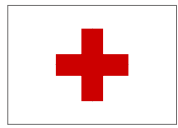

Red Cross

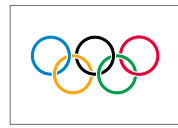

Olimpic Flags



Commonwealth



Autopro



Lannister



WWF

## Universities



Uni. Rey Juan Carlos



Harvard



Cambridge



Yale

## Sports



Cleveland Cavaliers



Chicago Bears

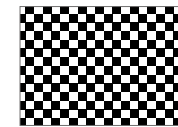

Chekered Flag

## Enterprises

## INFORMATION

The Wall Banner System is composed by a profile frame structure made of silver anodised lightweight aluminium and a full range of accessories for holding big size poster canvases. The wall banner system adopts a simple design to showcase your advertisement or promotional poster. Easy to assemble. The banner is attached by hanger clips through the grommets and fixed to the aluminium profile structure, allowing a simple and fast changing of the banner. Ideal for promoting your business or for displaying at outdoor exhibitions.

## PROFILE FOR WALL BANNER

### PROFILE DETAIL

### DIMENSIONS \*mm



REF  
13.483

REF  
13.484

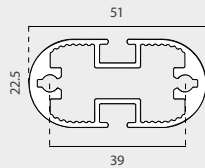

## INFORMATION

Lightweight profile made of anodised aluminium, available in 2 or 3m length.

2m BARS	QTY	N.W	G.W	C.B.M	SIZE
Packing	2	3.92kg	4.40kg	0.0115	75x75x2037mm
<b>13.484</b>	Length: 2000mm				x2 
3m BARS	QTY	N.W	G.W	C.B.M	SIZE
Packing	4	11.77kg	12.80kg	0.048	145x110x3010mm
<b>13.483</b>	Length: 3000mm				x4 

## WALL BANNER SYSTEM



## CORNER SUPPORT FOR WALL BANNER

### SUPPORT DETAILS

### INFORMATION \*mm

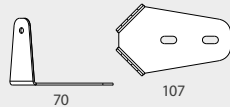

Made of 2mm sheet metal. It includes the fixing screws.

CORNER S.	QTY	N.W	G.W	C.B.M	SIZE
Packing	4	0.52kg	0.67kg	0.0021	105x120x165mm
<b>13.485</b>					x4 

## STRAIGHT SUPPORT FOR WALL BANNER

### SUPPORT DETAILS

### INFORMATION \*mm

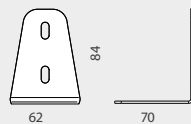

Made of 2mm sheet metal. It includes the fixing screws.

STRAIGHT S.	QTY	N.W	G.W	C.B.M	SIZE
Packing	4	0.41kg	0.56kg	0.0021	105x120x165mm
<b>13.486</b>					x4 





## CORNER CONNECTION FOR WALL BANNER

**CONNECTION DETAIL**      **INFORMATION**      **DIMENSIONS** \*mm

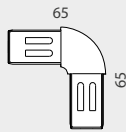

Corner Connection allows to connect aluminium profiles in the corner sections. It is made of polycarbonate. It includes the fixing screws.



CORNER C.	QTY	N.W	G.W	C.B.M	SIZE
Packing	8	0.14kg	0.30kg	0.0021	105x120x165mm
13.487	x4 				

## CORNER GRIPS FOR WALL BANNER

**GRIPS DETAIL**      **INFORMATION**      **DIMENSIONS** \*mm

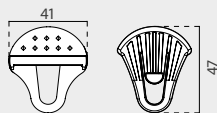

It allows to hang the banner with corners. Easy clip-on. Made of nylon.

CORNER GRIPS	QTY	N.W	G.W	C.B.M	SIZE
16.110	x40 				

## CANVAS HANGERS FOR WALL BANNER

**HANGER DETAIL**      **INFORMATION**      **DIMENSIONS** \*mm



This Hanger for wall banner allows to hang poster canvas and it is made of polycarbonate.

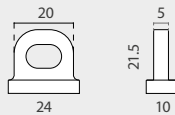

HANGERS	QTY	N.W	G.W	C.B.M	SIZE
13.334	x10 				

## WALL BANNER SYSTEM





## PROFILE CONNECTION FOR WALL BANNER

**HANGER DETAIL**      **INFORMATION**      **DIMENSIONS** \*mm

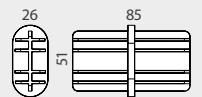

Profile Connection for the straight sections. Made of ABS plastic. With fixing screws.



PROFILE C.	QTY	N.W	G.W	C.B.M	SIZE
Packing	4	0.11kg	0.26kg	0.0021	105x120x165mm
13.488	x4 				

## DIMENSIONS

\*mm

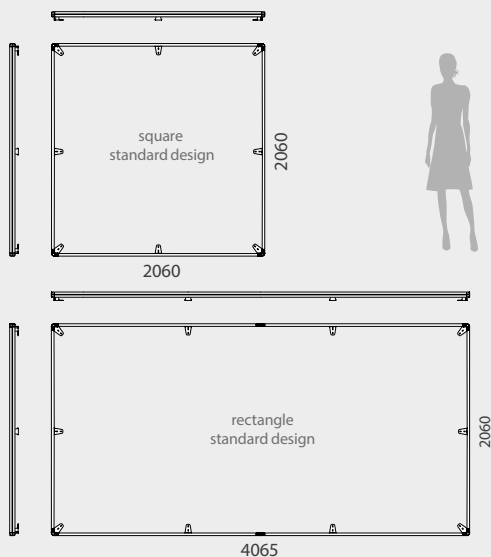

## EXAMPLES

### STANDARD CONFIGURATION



PROFILE DETAILS



CANVAS PROFILE FOR BIG SIZES

LED

- EN Aluminium profile with or without light system suitable for indoor/outdoor assembly canvas. Specially designed for large areas.
- FR Système de profil approprié pour toiles géantes ou de grandes aires. Disponible avec ou sans lumière, pour l'extérieur ou l'intérieur.
- PT Sistema de perfil com iluminação para impressões de grande formato ou grandes superfícies. Adequado para interior o exterior.
- ES Sistema de perfil adecuado para lonas gigantes o grandes áreas. Disponible con o sin sistema de luz y adecuado para exterior e interior.



TEXFIX DETAILS



INFORMATION

Click system frame available with or without LED System. Each Canvas Kit contains: Aluminium profiles, hanger canvas, corner connections, Led systems, power supply. The Power supplies are always placed outside the aluminium frame of the TexFix. Ideal for giant prints destined for out-of-home campaigns. It has a simple banner attachment system for banners destined either for outdoor or indoor environments. In many different applications, and specially designed for large areas, Canvas Profile can provide the answer for a smarter, better customized banner framing solution. Canvas profile is supplied in 3 standard kit sizes. There is a full range of possibilities, each suited to specific applications. Contact us for more details and information.

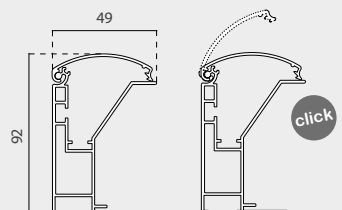

\*mm

PROFILE STANDARD SIZES

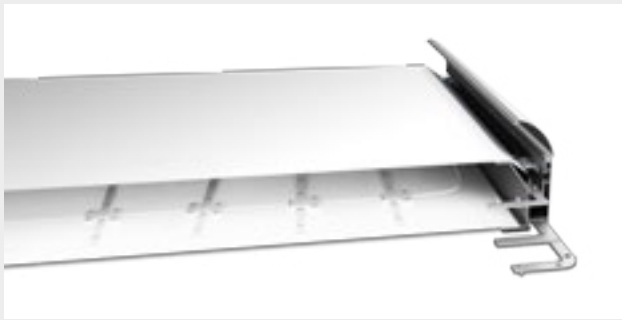

CANVAS PROFILE FOR BIG SIZES



CANVAS PROFILE STANDARD SIZES (INCLUDES LED)

CANVAS PRO	GRAPHIC SIZE
13.737	550x1300mm
13.738	1050x2540mm
13.739	1150x5040mm

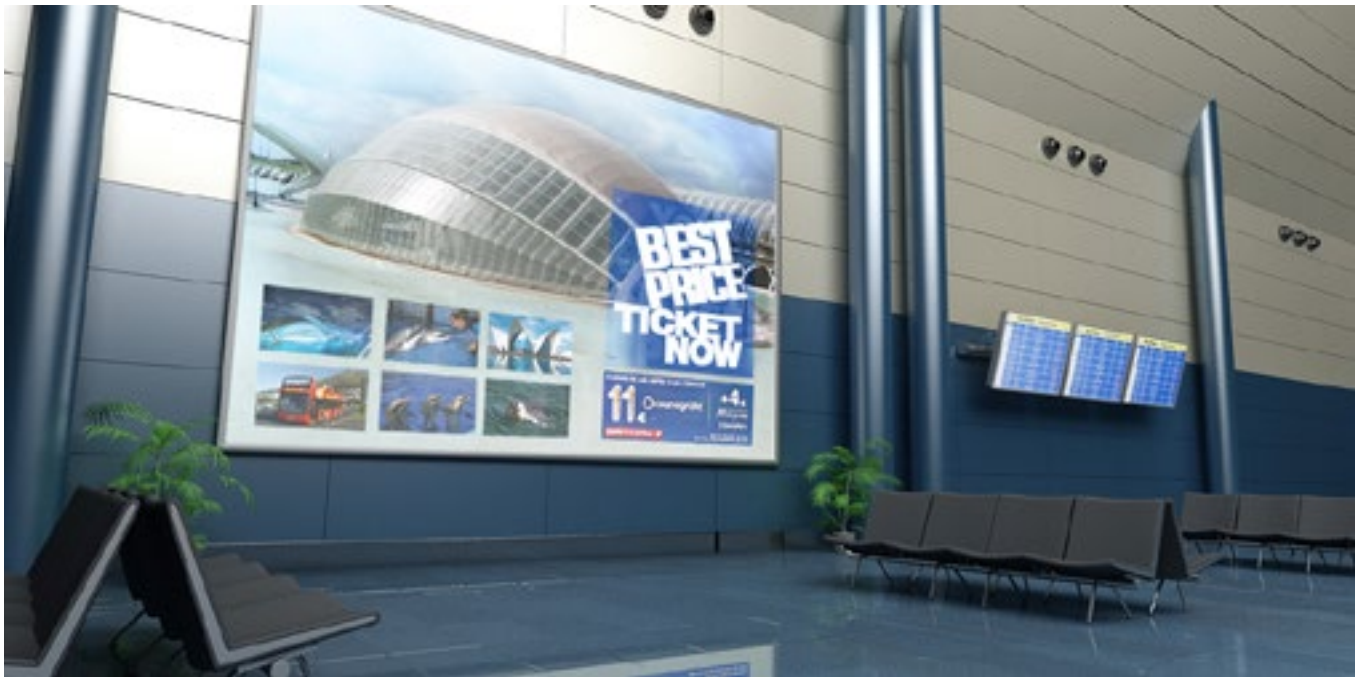

HANGERS FOR CANVAS PROFILE

HANGER DETAILS DIMENSIONS \*mm

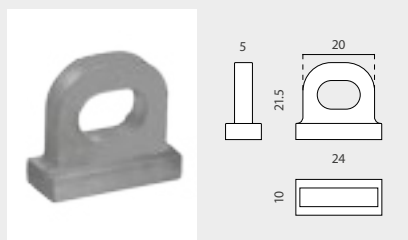

INFORMATION

This Hanger for Canvas profile is made of plastic and it is designed for holding canvas all along the profile. It is sold in 10 unit pack.

HANGER

13.334 x10 

WALL HANGERS FOR CANVAS PROFILE

HANGER DETAILS DIMENSIONS \*mm



Wall Hanger for Canvas is suitable for being used with the next profiles:

TexFix Canvas  
TexFix UltraSlim  
TexFix 80

WALL HANGER	QTY	N.W	G.W	C.B.M	SIZE
Packing	4	0.31kg	0.45kg	0.0004	85x45x115mm
13.708				x4 	

\*This Canvas Profile does not included the power cable connector.

## WALL POLE SUPPORT

STREET BANNER

### SUPPORT DETAILS

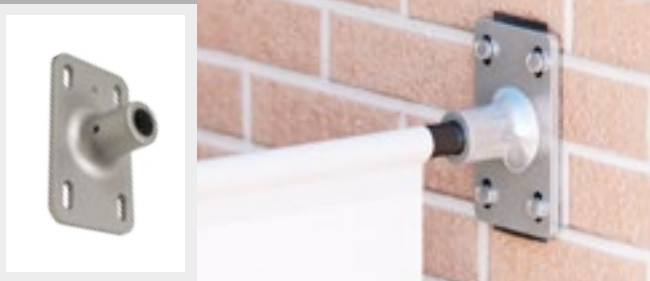

### KIT CONTENT



made of fiberglass

### INFORMATION

\*mm

Suitable for wall-mounting. Each kit consists of a Ø19mm pole, 1 metallic bracket, 1 pin with ring and mounting screws. Easy and fast banner change by removing the pin connecting the pole to the Wall-mounted bracket.

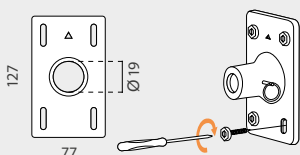

### SCREW

10.202	Pole 800mm		
10.203	Pole 1000mm		

## LAMP POLE CLAMPS

STREET BANNER

### SUPPORT DETAILS



### KIT CONTENT



made of fiberglass

### INFORMATION

\*mm

Suitable for outdoor lamps/posts. Each kit consists of a Ø19mm pole, 1 metallic bracket, 1 pin with ring and metallic adjustable bands. Easy banner change by removing the pin connecting the pole to the bracket.

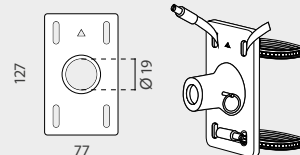

### CLAMPS

10.071	Pole 800mm		
10.072	Pole 1000mm		

## WALL SUPPORT

STREET BANNER

### SUPPORT DETAILS

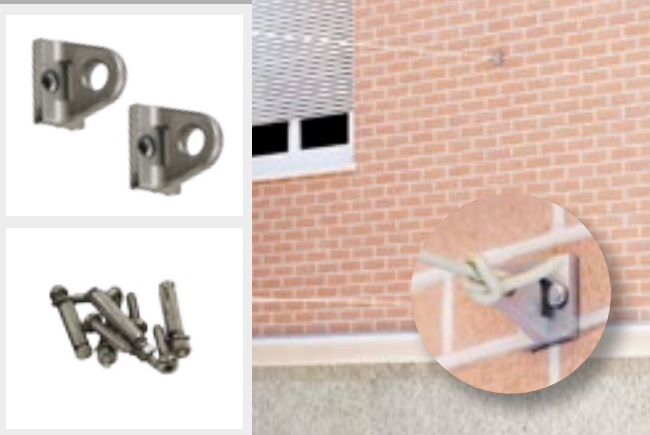

### INFORMATION

\*mm

This Banner Support is suitable for wall-mounting. Each kit consists of 2 brackets support and mounting screws. The Wall Support is ideal for hanging big size banners from the street.

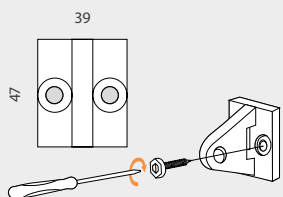

### MINI-SCREW

10.100	Wall-Mounted		
--------	--------------	--	--

## LAMP CLAMPS

STREET BANNER

### SUPPORT DETAILS



### INFORMATION

\*mm

Suitable for outdoor lamps/posts. Each kit consists of 2 brackets support and metallic adjustable bands. The Lamp Clamps are ideal for hanging big size banners at outdoor placements.

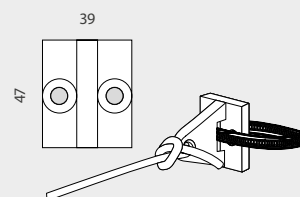

### MINI CLAMPS

10.099	Hose Clamps		
--------	-------------	--	--

SUPPORT DETAILS

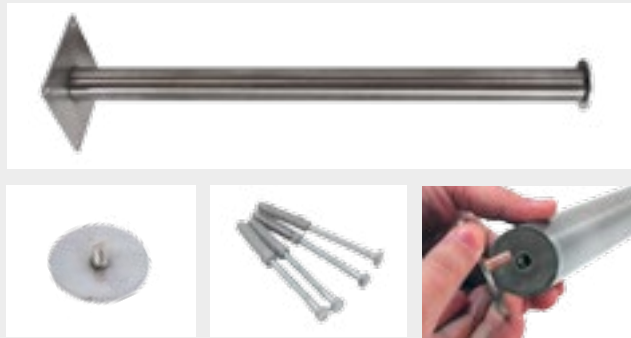

DIMENSIONS

\*mm



INFORMATION

Wall Pole features a heavy gauge stainless steel pole to which the flag banner is sleeved and securely mounted to the wall. Designed for resisting strong weather conditions. With a Ø60mm cap. Easy to assemble. Wall fixing screws included.

POLE 450	QTY	N.W	G.W	C.B.M	SIZE
Packing	2	2.20kg	2.64kg	0.0112	160x130x540mm
<b>10.453</b>	Pole Size: Ø 40x450mm			x2	
POLE 600	QTY	N.W	G.W	C.B.M	SIZE
Packing	2	2.46kg	3.00kg	0.0139	160x130x670mm
<b>10.454</b>	Pole Size: Ø 40x600mm			x2	

WALL POLE



SUPPORT DETAILS

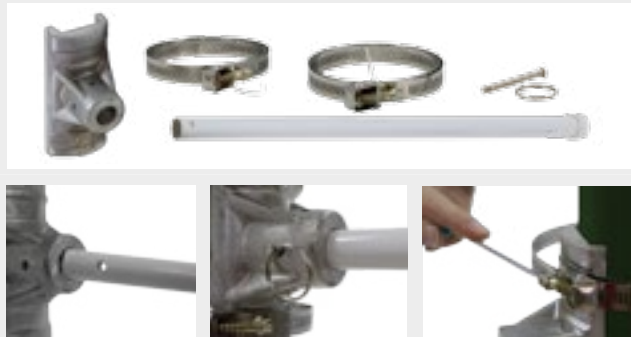

DIMENSIONS

\*mm

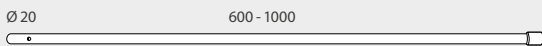

INFORMATION

This support is designed for resisting strong wind conditions, ideal for outdoor lamps/posts from the street. Each kit consists of a Ø20mm fiberglass pole (2 length available), 1 aluminium bracket, 1 pin, 1 ring and 2 stainless steel bands.

LAMP S. 600	QTY	N.W	G.W	C.B.M	SIZE
Packing	1	0.6kg	1.0kg	0.0039	100x65x610mm
<b>12.454</b>	Pole 600mm			x2	
LAMP S. 1000	QTY	N.W	G.W	C.B.M	SIZE
Packing	1	1.0kg	1.35kg	0.006	100x65x1010mm
<b>12.353</b>	Pole 1000mm			x2	

LAMP SYSTEM

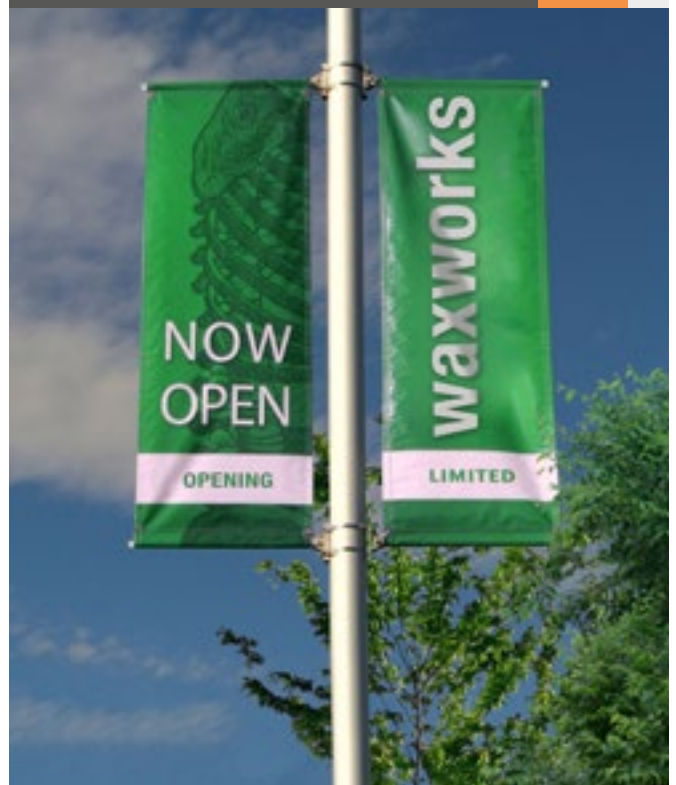

DISPLAY DETAILS





INFORMATION

DIMENSIONS

\*mm

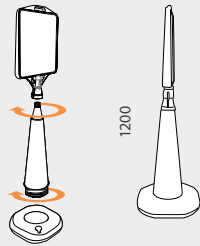
Charleroi is a 2-sided outdoor banner made of plastic, easy to install. It allows to fix 330x382mm graphics. Its base can be filled with 4l of water or sand, which adds stability to the banner. Also, it allows the barriers mounting thanks to its 2 chain connections. Lightweight for transport. It is ideal for indoor or outdoor use like shop entrances, sidewalks gardens, restaurant terraces, etc.



CHARLEROI	QTY	N.W	G.W	C.B.M	SIZE
Packing	1	2kg	2.5kg	0.07	500x200x690mm 
10.248	Graphic Size: 330x382mm				

CHARLEROI

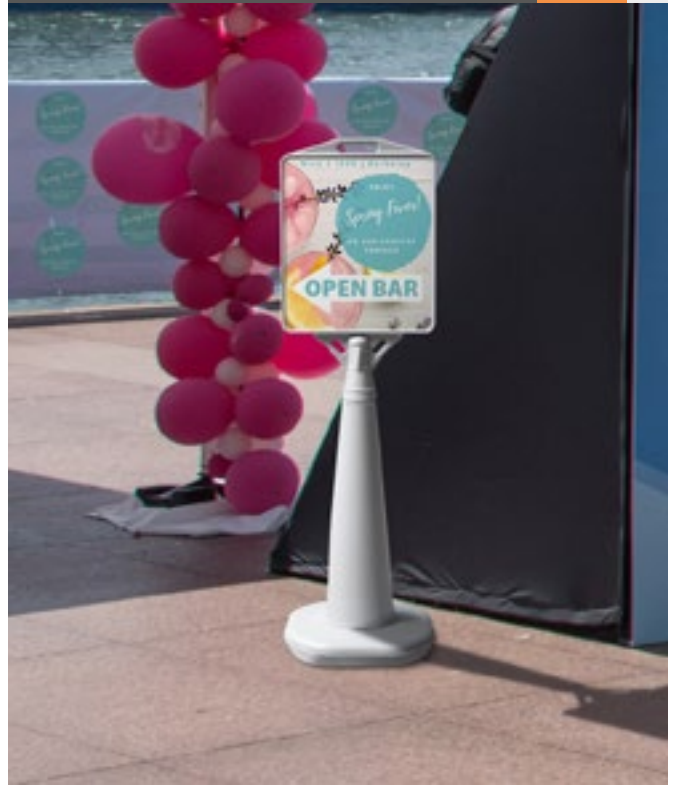

DISPLAY DETAILS

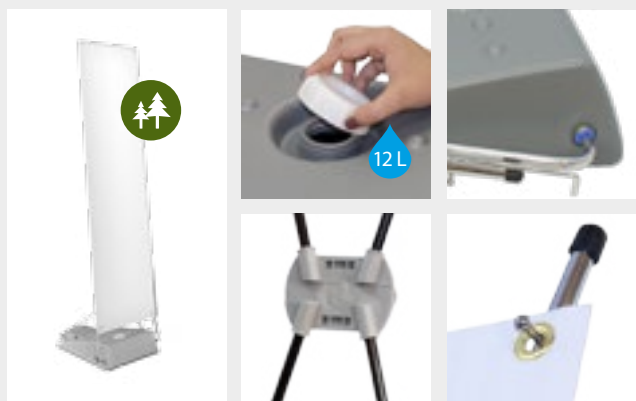



INFORMATION

\*mm

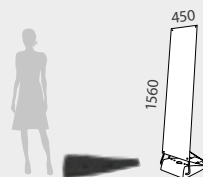
Medinaceli is a detachable stand display with a refillable 12l water plastic base which is suitable for indoor and outdoor use. The change of graphic is simple and takes only a few seconds. Includes a nylon Carry Bag for an easy transport and storing.



MEDINACELLI	QTY	N.W	G.W	C.B.M	SIZE
Packing	2	7kg	8.6kg	0.11	540x190x1050mm  
Uni.	1	2.85kg	3.50kg	0.05	500x100x1030mm
10.026	Graphic Size: 450x1560mm				

MEDINACELI





DISPLAY DETAILS



INFORMATION

\*mm

This portable and detachable display stand features a water refillable base, 6 litres capacity. Made of fiberglass, plastic and lacquered aluminium. Suitable for indoor and outdoor use, features an easy interchange of graphics. Carry bag is included.

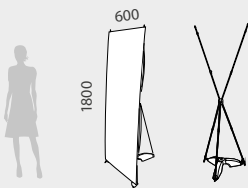

ALMAZAN	QTY	N.W	G.W	C.B.M	SIZE
Pole	1	0.55kg	0.6kg	0.004	80x65x750mm
Base	1	0.95kg	1kg	0.015	250x170x350mm
10.028	Graphic Size: 600x1800mm				



ALMAZAN



DISPLAY DETAILS



INFORMATION

\*mm

This portable and detachable display stand features a water refillable base, 6 litres capacity. Made of fiberglass, plastic and lacquered aluminium. Suitable for indoor and outdoor use, features an easy interchange of graphics and adjustable height (telescopic). Carry bag is included.

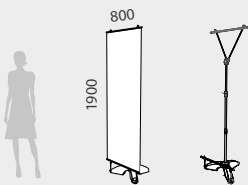

ALMENAR	QTY	N.W	G.W	C.B.M	SIZE
Packing	6	13kg	16.20kg	0.1	400x320x850mm
Uni.	1	1.8kg	2.2kg	0.02	240x100x840mm
10.029	Graphic Size: 800x1900mm				



ALMENAR



BASE DETAILS



BASE DETAILS

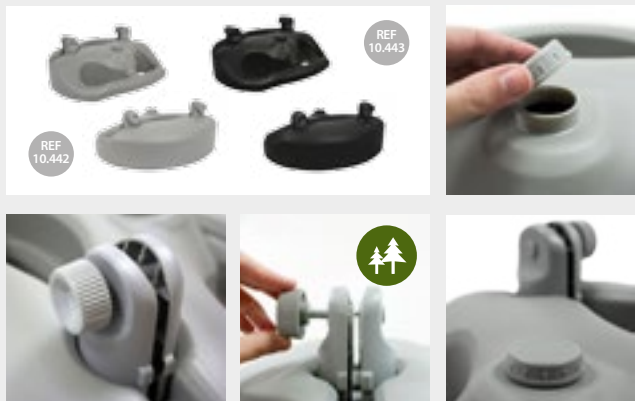

INFORMATION

\*mm



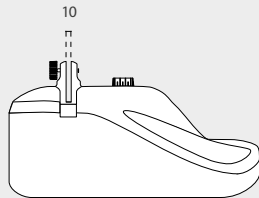

With a durable design and easy portability, this double-sided base with corrugated plastic insert is ideal for placing outdoors, in areas with high foot traffic to draw in new customers. The weighted poster holder can be filled with up to 5l of water or sand. This base is available on Grey or black color.



PANELFIX WING  
OUTDOOR



\* Boards are available but not included. The price includes only the base.

PANELFIX WING	QTY	N.W	G.W	C.B.M	SIZE	
Packing	1	2kg	2.55kg	0.04	440x190x520mm	 
10.442						
10.443						

DISPLAY DETAILS

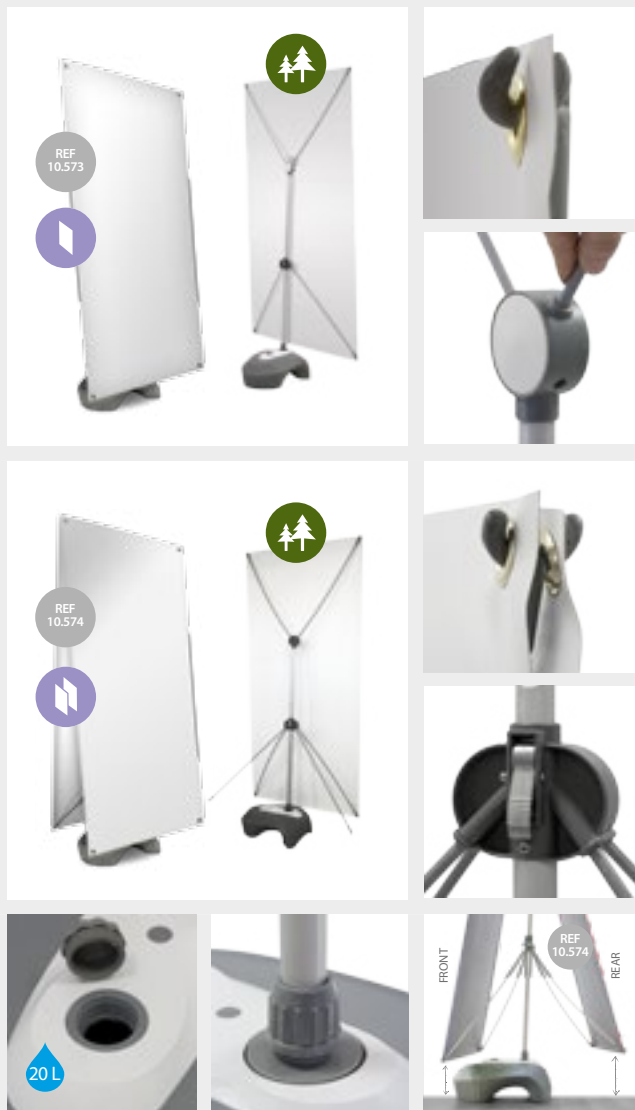

INFORMATION

\*mm

This stand display features a 20l water refillable base. The central telescopic hub allows fast height adjustment. Kiel is ideal for indoor or outdoor use. Graphics are held with a simple and fast eyelet system. Kiel 10.574 can be used to present a double-sided graphic in areas with 2-ways traffic (after the placement of graphs, the distance to the ground on both sides can differentiate each other: ± 50mm).

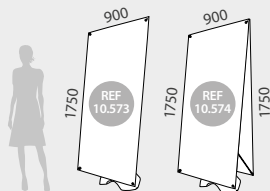

KIEL SINGLE	QTY	N.W	G.W	C.B.M	SIZE
Packing	1	2.8kg	3.25kg	0.09	400x200x1080mm
10.573	Graphic Size: 900x1750mm				
KIEL DOUBLE	QTY	N.W	G.W	C.B.M	SIZE
Packing	1	3kg	3.45kg	0.09	400x200x1080mm
10.574	Graphic Size: 900x1750mm x2				

KIEL





### BANNER SUPPORT DETAILS

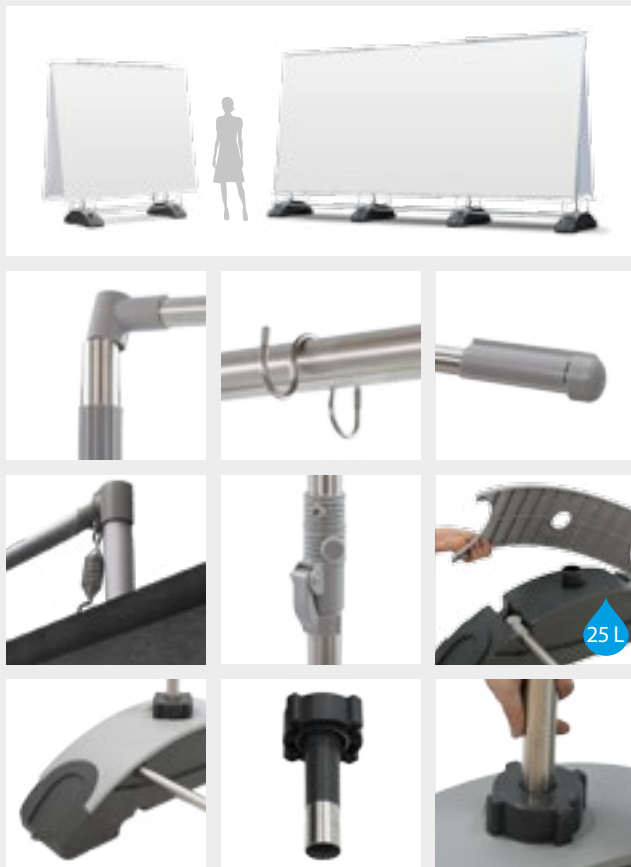

### DIMENSIONS

\*mm

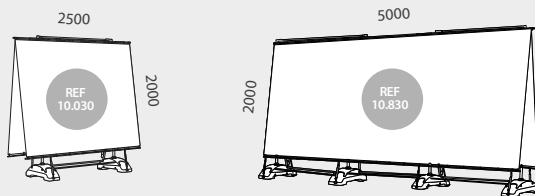

### INFORMATION

The Barahona 10.030 Model features 2 Bases (fill each one with 25l water or sand) and a one or two-sided design for displaying large graphic banners so it is perfect for an outdoor use where bases can resist strong wind conditions. The Barahona 10.830 features 4 Bases (fill each one with 25l of water or sand). Its 4 ultra-large bases are very stable for an outdoor use, which ones are available to resist strong wind conditions. This Barahona model is the first choice for a huge outdoor display background (visual: 5000x2000mm).

BARAHONA 1	QTY	N.W	G.W	C.B.M	SIZE
Pole	1	11.5kg	16kg	0.04	410x210x1660mm
Base	1	8kg	9kg	0.11	430x310x850mm

10.030 Graphic Size: 2500x2000mm

BARAHONA 2	QTY	N.W	G.W	C.B.M	SIZE
Pole	1	17.2kg	21.1kg	0.044	170x150x1720mm
Base	1	13.30kg	18.3kg	0.12	470x300x850mm

10.830 Graphic Size: 5000x2000mm

## BARAHONA



### SIDELINE BANNER DETAILS



\*Printed on fabric.  
Impression sur toile.  
Impressão em tecido.  
Impresión en tela.

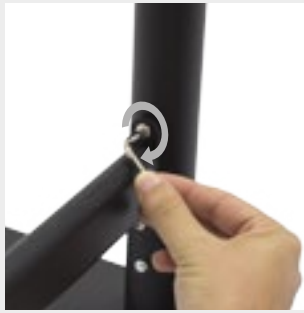

### DIMENSIONS

### ARTWORK

\*mm

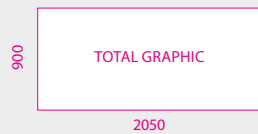
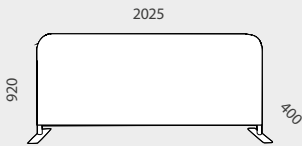

### INFORMATION

This promotional Sideline Banner features a lightweight aluminum structure, the design of its structure allows its customization with a double-sided textile cover for printing your advertisement or your own corporate logo. Includes carrying bag and it is supplied with stakes for fixing to the ground.

MANAUS	QTY	N.W	G.W	C.B.M	SIZE
Packing	1	5kg	5.2kg	0.04	210x190x1000mm
10.791	Graphic Size: 2050x900mm				

## MANAUS SIDELINE BANNER



**SIDELINE BANNER DETAILS**



**EXTERNAL SIZE**                      **ARTWORK**                      \*mm

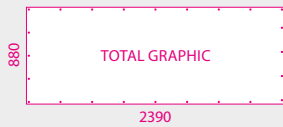
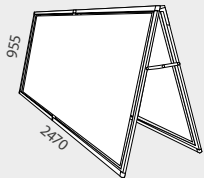

**INFORMATION**

This promotional Sideline Banner is made of lightweight aluminum, the design of its structure allows its customization with a double-sided canvas for printing your advertisement or your own corporate logo. Includes carrying bag for an easy transportation and storing.

PARANA	QTY	N.W	G.W	C.B.M	SIZE
Packing	1	7kg	8.1kg	0.049	200x200x1220mm
10.548	Graphic Size: 2390x880mm				

**PARANA**  
SIDELINE BANNER



**SIDELINE BANNER DETAILS**

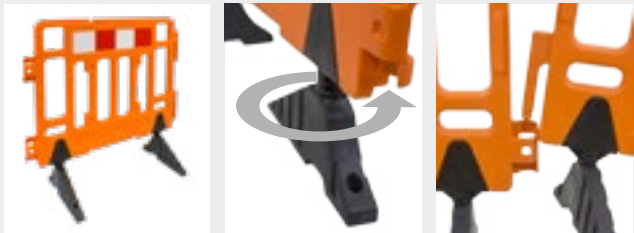

**DIMENSIONS**                      \*mm

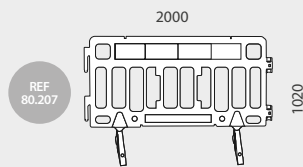
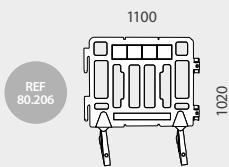

**INFORMATION**

This promotional barrier banner is made of lightweight plastic, features a bottom space for customizing, has reflective stripes at the top and rotating bases. Ideal for events thanks to its linkable design. Includes carrying bag for an easy transportation. 1100mm or 2000mm width available.

BARRIER 1100	QTY	N.W	G.W	C.B.M	SIZE
Packing	1	8.95kg	9.95kg	0.086	1070x70x1150mm
80.206	External Size: 1100x1020x50mm				

BARRIER 2000	QTY	N.W	G.W	C.B.M	SIZE
Packing	1	13kg	14kg	0.153	1070x70x2050mm
80.207	External Size: 2000x1020x50mm				

**LINKABLE**  
SIDELINE BANNER



# STANCHIONS 04

Collection of belt and rope stanchions and its proper accessories for creating guide patrons and configurations of queuing systems.

- 186** BELT STANCHIONS
- 191** BELT STANCHIONS ACCESSORIES
- 192** WALL BELT BARRIER
- 193** ROPE STANCHIONS
- 196** ROPE STANCHIONS ACCESSORIES



## STANCHIONS DETAILS

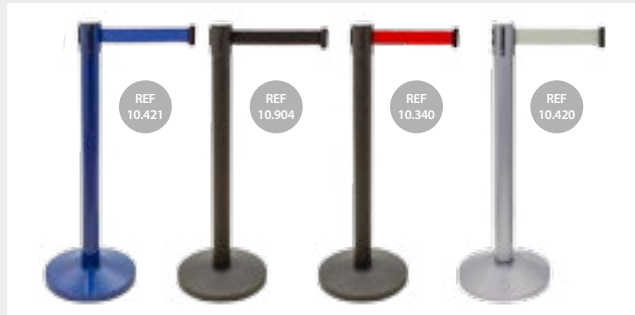

### INFORMATION

These 910mm height Stanchions have a Ø63mm pole and they are constructed from sturdy, durable powder coated steel available in 8 colors. Featuring a Ø320mm cement dome base which adds stability, and a 2m retractable belt (8 colors available) with security lock and built-in 4-way adaptor which expands possibilities. Easy to assemble & disassemble (for storing or transport). Ideal for higher traffic areas like lobbies, waiting areas, airports, food lines, registration offices and anywhere else you have the need to guide patrons.

### DIMENSIONS



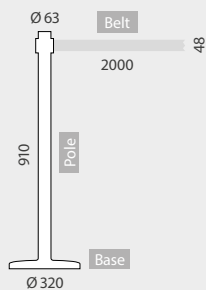









\*mm



## CLASSIC STANCHION WITH RETRACTABLE BELT



### CLASSIC STANCHION WITH RETRACTABLE BELT

	POLE COLOR	BELT COLOR	
10.335	Yellow 1235C 	Yellow 107C 	x2 
10.331	Orange 2027C 	Orange 394C 	
10.336	Red 2035C 	Red 206C 	
10.330	Green 323C 	Green 561C 	
10.421	Blue 280C 	Blue 286U 	
10.904	Black 6C 	Black 3C 	
10.340	Black 6C 	Red 206C 	
10.420	Grey 2162C 	Grey 7537C 	



## STANCHIONS DETAILS

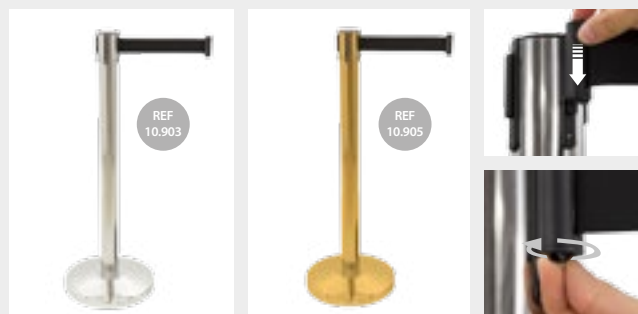

### INFORMATION

This 910mm height Polished Stylish Stanchion has a Ø63mm pole made with durable steel parts (silver or golden color available). With a Ø320mm cement dome base which adds stability to the stanchion and 2m retractable black belt with security lock and built-in 4-way adaptor which expands possibilities. Easy to assemble and disassemble (for storing or transport). Ideal for higher traffic areas like lobbies, airports, registration offices and anywhere else you have the need to guide patrons.

### DIMENSIONS \*mm

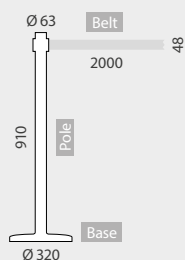

### POLISHED STANCHION

	POLE COLOR	BELT COLOR	OUTER SIZE	
10.903	Silver	Black 3C	Ø320x910mm	x2
10.905	Golden	Black 3C	Ø320x910mm	x2

## POLISHED STANCHION WITH RETRACTABLE BELT



## STANCHIONS DETAILS

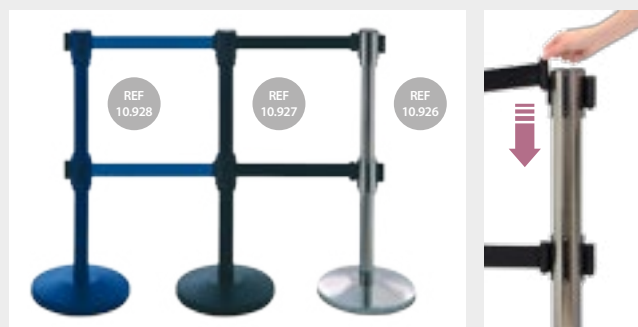

### INFORMATION

This 910mm height Stanchion has a Ø63mm pole. It is constructed with sturdy, durable steel parts (3 colors available: blue, black or silver). Its Ø320mm cement dome base adds stability to the stanchion and the double 2m retractable belt built-in 4-way adaptor expands possibilities. It is easy to assemble & disassemble (for storing or transport). Ideal for higher traffic areas like lobbies, waiting areas, airports, food lines, registration offices and anywhere else you have the need to guide patrons.

### DIMENSIONS \*mm

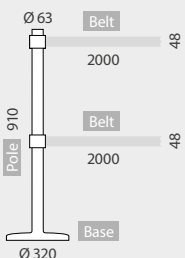

### DOUBLE BELT STANCHION

	POLE COLOR	BELT COLOR	OUTER SIZE	
10.927	Black 6C	Black 3C	Ø320x910mm	x2
10.928	Blue 280C	Blue 286U	Ø320x910mm	x2
10.926	Silver	Black 3C	Ø320x910mm	x2

## DOUBLE RETRACTABLE BELT STANCHION



## STANCHIONS DETAILS

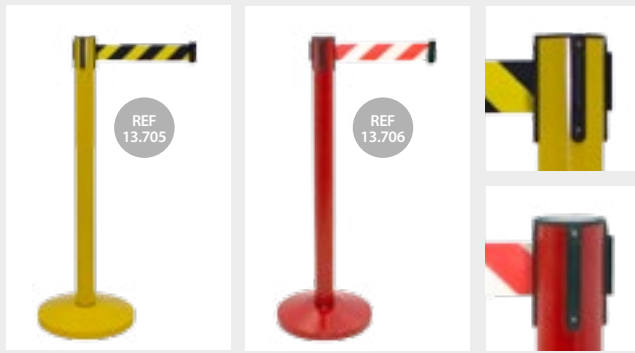

### INFORMATION



This 910mm height Stanchion has a Ø63mm pole. It is constructed from sturdy, durable powder coated steel, available in red or yellow. Its Ø320mm cement dome base adds stability to the stanchion. The 2m striped retractable belt and a built-in 4-way adaptor expands the possibilities. Easy to assemble & disassemble (for storing or transport). It is ideal for areas like hangars, warehouses, factories areas, airports, work lines and any where it is necessary to protect areas or to mark zones of prohibited access.

### DIMENSIONS

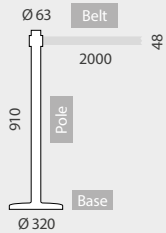
\*mm



### HIGH VISIBILITY STANCHION

	POLE COLOR	BELT COLOR		
13.705	Yellow 1235C	Y 108C/B 3C		x2 
13.706	Red 2035C	R 185C/White		

## HIGH VISIBILITY STANCHION WITH STRIPED BELT



## STANCHIONS DETAILS

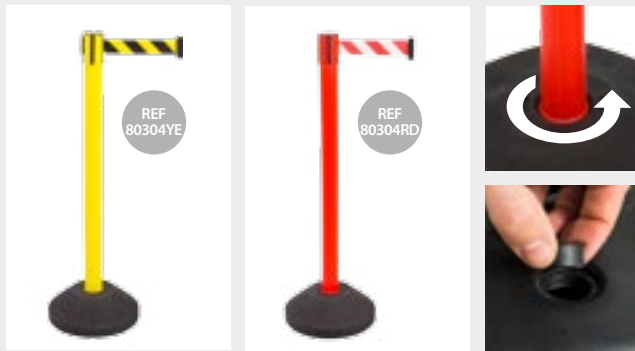

### INFORMATION



This 910mm height Stanchion has a Ø63mm pole available in red or yellow color. Featuring a plastic base that can be filled with 1 kg of weight, which adds stability to the stanchion, a 2100mm striped retractable belt and a built-in 4-way adaptor which expands the possibilities. This stanchion is easy to assemble & disassemble (for storing or transport). It is ideal for areas like hangars, warehouses, factories areas, for airports, work lines and for any where it is necessary to protect areas or to mark zones of prohibited access.

### DIMENSIONS

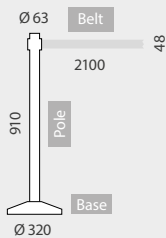
\*mm



### STANCHION WITH REFILLABLE BASE

	POLE COLOR	BELT COLOR		
80304YE	Yellow	Yellow/Black		x6 
80304RD	Red	Red/White		

## HIGH VISIBILITY STANCHION WITH REFILLABLE PLASTIC BASE



## STANCHIONS DETAILS

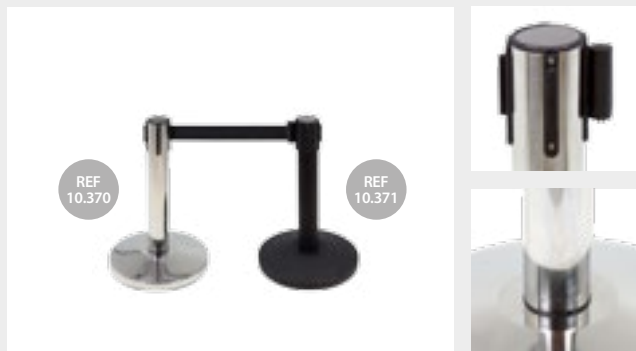





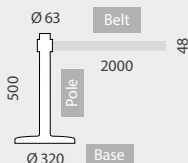

### INFORMATION

### DIMENSIONS \*mm

This 500mm height Stanchion is constructed with durable steel parts. It is available in 2 colors: silver or black finish. With a Ø63mm pole, a Ø320mm cement dome base which adds stability to the stanchion and a 2m black retractable belt and a built-in 4-way adaptor which expands possibilities. Easy to assemble & disassemble (for storing or transport). It is ideal for dealers, museums, galleries or for showrooms thanks to its small dimensions which allows a perfect exhibition.



### SMALL STANCHION

	POLE COLOR	BELT COLOR			
10.370	Silver		Black 3C		x2 
10.371	Black		Black 3C		x2 

## SMALL STANCHION WITH RETRACTABLE BELT



## STANCHIONS DETAILS

## ROLLER USE







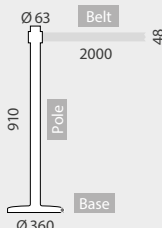

### INFORMATION

### DIMENSIONS \*mm

This 910mm height Stanchion is constructed from sturdy, durable powder coated steel. It features a Ø63mm pole and a Ø360mm base with side roller which allows an easy transport of the stanchion to any other place where it is used. Also it features a 2m retractable black belt built-in 4-way adaptor which expands the possibilities. Easy to assemble & disassemble (for storing). Ideal for higher traffic areas at specific times of the day like lobbies, airports or registration offices.



### ROLLER STANCHION

	POLE COLOR	BELT COLOR			
10.930	Black		Black 3C		x2 
10.929	Silver		Black 3C		x2 

## ROLLER STANCHION WITH RETRACTABLE BELT



## STANCHIONS DETAILS



## STACKABLE STANCHION WITH RETRACTABLE BELT



### INFORMATION





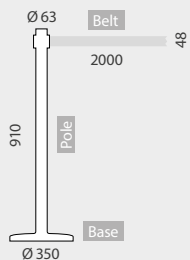

This 910mm height Stanchion is constructed with sturdy, durable steel parts, available in silver or black finish. Featuring a  $\varnothing 63$ mm pole, a  $\varnothing 350$ mm metallic base which adds stability to the stanchion, a 2m black retractable belt and a built-in 4-way adaptor which expands the possibilities. Easy to assemble & disassemble (for storing or transport). It is ideal for dealers, museums, for galleries, airports or for showrooms, thanks to the special design of its base, suitable for stacking the poles.

### DIMENSIONS

\*mm



### STACKABLE STANCHION

	POLE COLOR	BELT COLOR	OUTER SIZE		
10.121	Black 	Black 	$\varnothing 350 \times 910$ mm	x2	
10.118	Silver 	Black 	$\varnothing 350 \times 910$ mm	x2	

## BOWLS DETAILS



### INFORMATION

These bowls are suitable for poles up to Ø63mm. They are ideal for arranging brightening queues with business cards, candies or goodies at tradeshows, airports, theaters, or lobbies for displaying promotional items of the event.

### DIMENSIONS

\*mm

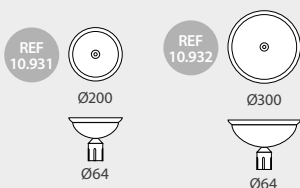

### BOWL WITH CONNECTOR

	Ø BOWL	
10.931	200mm	
10.932	300mm	

## BOWL AND CONNECTOR



## FRAMES DETAILS



### INFORMATION



This frame for retractable belt stanchions provides a solid support for signage in queuing. You can insert a graphic element through the top of the frame. Includes two-sided graphic holder system. It is available in gold or silver color. Ideal for use in museums, galleries, exhibitions, showrooms or retailers.

### DIMENSIONS

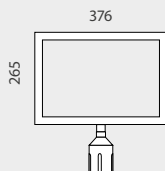
\*mm



### SIGN BOARD WITH CONNECTOR

	FRAME COLOR		GRAPHIC SIZE
10.916	Silver		370x260x3mm
10.917	Golden		370x260x3mm

## SIGN BOARD FOR STANCHIONS



\* the stanchions at this page are available but not included

# WALL BELT BARRIER Wall Barrier

## BELTS DETAILS



### INFORMATION DIMENSIONS INCLUDED KIT \*mm

With 2m long retractable belt in several colors. Wall receiver and screws included.

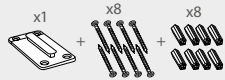
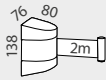

	CASE COLOR	BELT COLOR	BELT LENGTH
13.700	485C	206C	2m
13.701	Black 6C	Black 3C	2m
13.702	7549C	107C	2m
13.703	485C	R 185C/White	2m
13.704	7549C	Y108C/B 3C	2m

## BELTS DETAILS

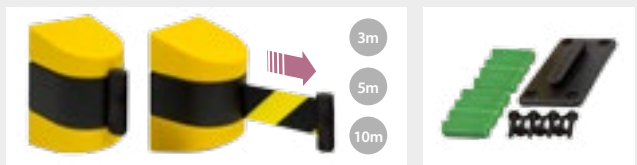

### INFORMATION DIMENSIONS INCLUDED KIT \*mm

With 3 lengths black and yellow striped retractable belt. Wall receiver and screws included.

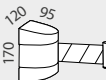

	CASE COLOR	BELT COLOR	BELT LENGTH
13.767	Yellow/Black	Yellow/Black	3m
13.768	Yellow/Black	Yellow/Black	5m
13.769	Yellow/Black	Yellow/Black	10m

## BELTS DETAILS



### INFORMATION DIMENSIONS INCLUDED KIT \*mm

With 2m long black retractable belt. 3-way belt adaptor. Wall receiver and screws are included.

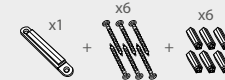
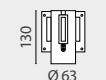

	CASE COLOR	SIZE	BELT COLOR	BELT LENGTH
10.918	Black	Ø63x130mm	Black	2m
10.975	Silver	Ø63x130mm	Black	2m

## CONNECTOR DETAILS

### INFORMATION

\*mm



This receiver is made of plastic and it is ideal as wall connector for the retractable belts. Screws are included.

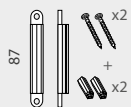

	LENGTH
10.918P	87mm

## WALL BARRIER WITH RETRACTABLE BELT

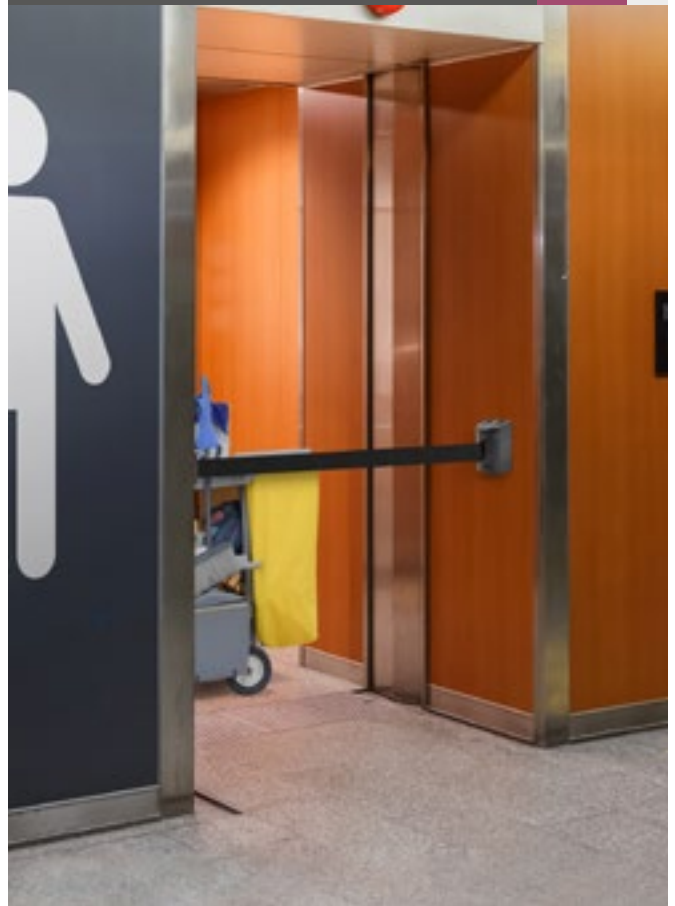

## WALL MOUNTED TENSOROPE SUPPORT



## WALL RECEIVER



STANCHION DETAILS





INFORMATION

\*mm

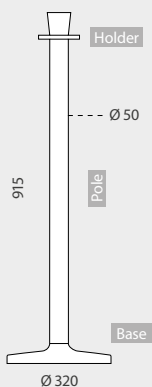
This traditional Stanchion features a royal stylish top with tulip shape. It features a 915mm high Ø50mm pole and it is made of a sturdy and durable steel parts with polished chrome finish. Also, it has a Ø320mm notched cement dome base which adds stability to the stanchion and built-in 4-way ring holder which expands the possibilities. It is ideal to add a touch of distinction to your queuing controls thanks to its classic design top, so it is perfect for being used at higher traffic areas like hotels, theaters, lobbies, restaurants, at the airports or anywhere else you have the need to guide patrons.



TULIP STANCHION

	POLE COLOR	Ø POLE	Ø BASE	HEIGHT	
10.207	Chrome 	50mm	320mm	915mm	x2 

TULIP EXCELSIOR STANCHION



\* ropes at this page are available but not included

## STANCHION DETAILS

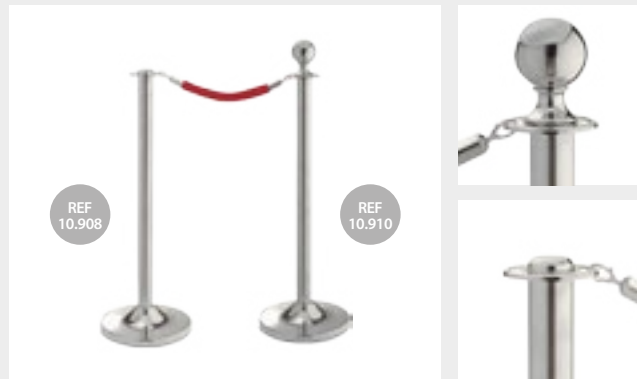

### INFORMATION

This classic Stanchion features flat or ball top. It is constructed with sturdy, durable steel parts with polished chrome finish. With a Ø50mm pole, a Ø320mm cement dome base which adds stability to the stanchion and a built-in 4-way ring holder. Ideal for higher traffic areas like theaters, lobbies, restaurants, airports or anywhere else you have the need to guide patrons.

### DIMENSIONS

\*mm

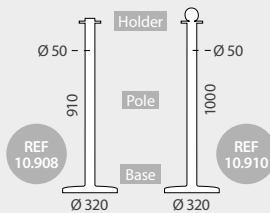

### CLASSIC CHROMED STANCHION

	POLE COLOR		Ø POLE	Ø BASE	HEIGHT	
10.908	Chrome		50mm	320mm	910mm	x2 
10.910	Chrome		50mm	320mm	1000mm	x2 

## CLASSIC CHROMED STANCHION FOR ROPES

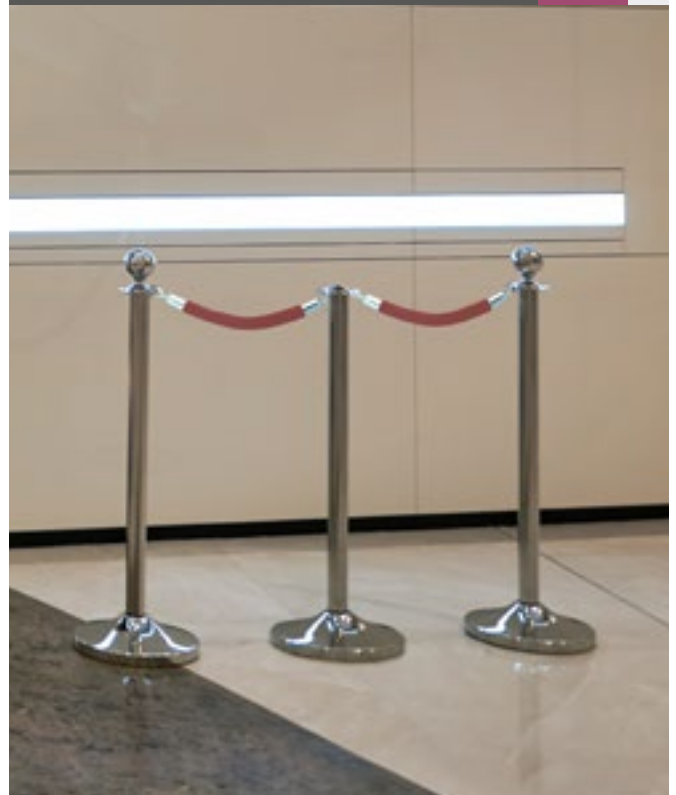

## STANCHION DETAILS

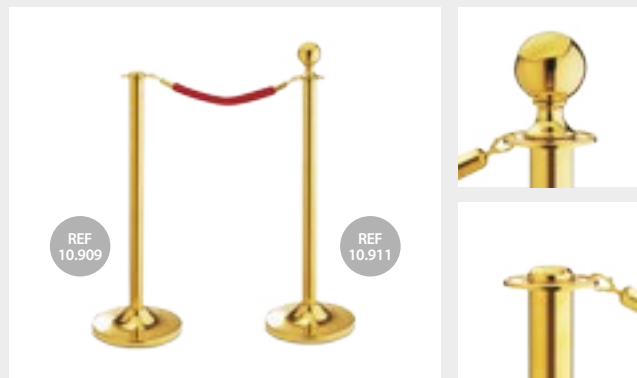

### INFORMATION

This classic Stanchion features flat or ball top. It is constructed with sturdy, durable steel parts with polished golden finish. With a Ø50mm pole, a Ø320mm cement dome base which adds stability to the stanchion and a built-in 4-way ring holder. Ideal for higher traffic areas like theaters, lobbies, restaurants, airports or anywhere else you have the need to guide patrons.

### DIMENSIONS

\*mm

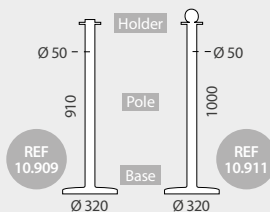

### CLASSIC BRASS STANCHION

	POLE COLOR		Ø POLE	Ø BASE	HEIGHT	
10.909	Golden		50mm	320mm	910mm	x2 
10.911	Golden		50mm	320mm	1000mm	x2 

## CLASSIC BRASS STANCHION FOR ROPES



\* ropes at this page are available but not included



## STANCHION DETAILS



### INFORMATION

This classic Stanchion is 1300mm height. It is constructed with sturdy, durable steel parts with polished chrome or gold finish. It features a landscape format 420x320mm frame (with a 3mm thickness panel included) for displaying information signages. With a Ø50mm pole, a Ø320mm cement dome base which adds stability to the stanchion and a built-in 4-way ring holder. Ideal for theaters, lobbies, hotels, airports or anywhere else you need to show information or the schedule of the event.

### DIMENSIONS \*mm

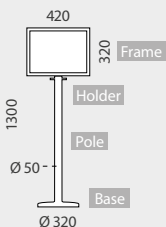

#### LANDSCAPE SIGN FRAME STANCHION

	POLE COLOR	Ø POLE	Ø BASE	HEIGHT	GRAPHIC SIZE	
10.914	Chrome 	50mm	320mm	1300mm	420x320mm	x2 
10.915	Golden 	50mm	320mm	1300mm	420x320mm	x2 

## LANDSCAPE SIGN FRAME STANCHION



## STANCHION DETAILS

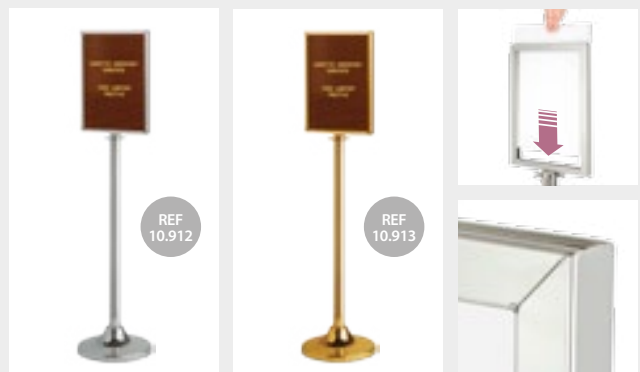

### INFORMATION

This classic Stanchion is 1440mm height. It is constructed with sturdy, durable steel parts with polished chrome or gold finish. It features a portrait format 320x420mm frame (with a 3mm thickness panel included) for displaying information signages. With a Ø50mm pole, a Ø320mm cement dome base which adds stability to the stanchion and a built-in 4-way ring holder. Ideal for theaters, lobbies, hotels, airports or anywhere else you need to show information or the schedule of the event.

### DIMENSIONS \*mm

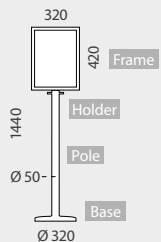

#### PORTRAIT SIGN FRAME STANCHION

	POLE COLOR	Ø POLE	Ø BASE	HEIGHT	GRAPHIC SIZE	
10.912	Chrome 	50mm	320mm	1440mm	320x420mm	x2 
10.913	Golden 	50mm	320mm	1440mm	320x420mm	x2 

## PORTRAIT SIGN FRAME STANCHION



\* ropes at this page are available but not included

ROPES DETAILS



	ROPE COLOR	END COLOR	LENGTH	Ø ROPE
10.919	2035C	Silver	1500mm	32mm
10.920	Black 6C	Silver	1500mm	32mm
13.760	281C	Silver	1500mm	32mm
10.921	2035C	Golden	1500mm	32mm
10.922	Black 6C	Golden	1500mm	32mm
13.761	281C	Golden	1500mm	32mm

VELOUR ROPES



## ROPES DETAILS



	ROPE COLOR	END COLOR	LENGTH	Ø ROPE
10.923	294C	Silver	1500mm	32mm
10.977	WHITE	Silver	1500mm	32mm
13.762	198C	Silver	1500mm	32mm
13.764	BLACK	Silver	1500mm	32mm
13.766	WH+198C	Silver	1500mm	32mm
10.925	294C	Golden	1500mm	32mm
10.976	WHITE	Golden	1500mm	32mm
10.924	198C	Golden	1500mm	32mm
13.763	BLACK	Golden	1500mm	32mm
13.765	WH+198C	Golden	1500mm	32mm

## BRAIDED ROPES



## HANGERS DETAILS

### INFORMATION

### DIMENSIONS \*mm



These metallic hangers for wall mounting are suitable for being used with ropes (screws are included) and they are ideal for being used at events, restaurants clubs, theaters or at airports.

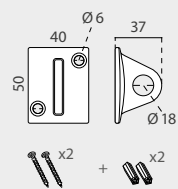

	FINISH	SIZE
13.446	Silver	40x50x37mm
13.447	Golden	40x50x37mm

## WALL HANGER FOR ROPES

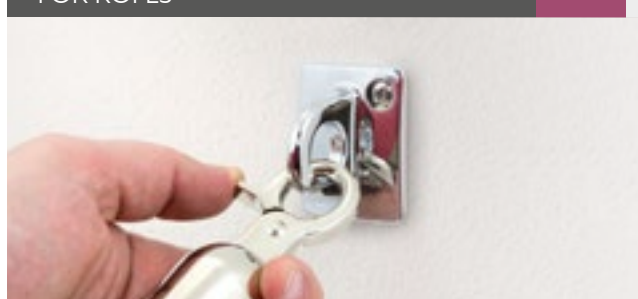

## BARS DETAILS



## INFORMATION

\*mm

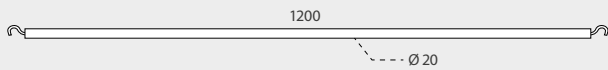

These Ø20mm tube bars for rope stanchions feature a chrome finish and have a total length of 1200mm. They are ideal for supporting and displaying graphics.

## CHROMED BARS

	COLOR		LENGTH	Ø TUBE
10.990	Chrome		1200mm	Ø 20mm

## 1200mm CHROMED BARS FOR STANCHIONS



## RING DETAILS

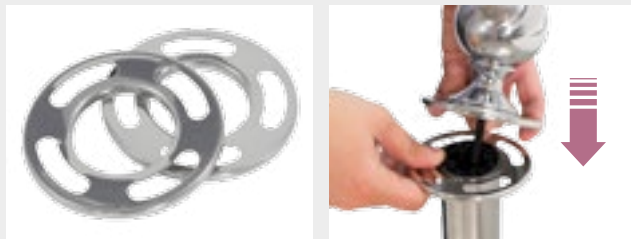

## INFORMATION

## DIMENSIONS

\*mm

This Ø100mm Ring for rope stanchions is made of stainless steel with a chrome finish. With a 4-way design, this ring holder is ideal for being used with ropes at higher traffic areas like theaters, lobbies, restaurants or at the airport zones. Simple and fast to assemble.

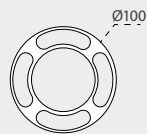

## CHROMED RING

	COLOR		Ø RING
10.991	Chrome		100mm

## Ø100mm CHROMED RING FOR STANCHIONS



\* example with graphic (graphic and stanchions are available but not included).

# TENTS 05

Complete range of tents and outdoor displays which provide an integral solution for the exhibition at outdoor events or business presentations.

- 200** STEEL TENTS
- 203** ALUMINIUM TENT
- 204** TENT ACCESSORIES
- 205** INFLATABLES
- 210** BICYCLE STAND



## TENT DETAILS



## DIMENSIONS

\*mm

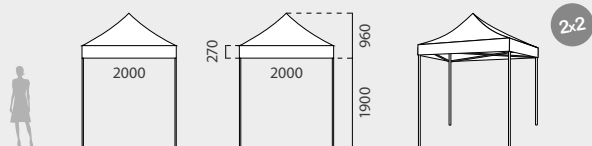

## INFORMATION

This 2x2 portable tent features a steel truss frame and a cover top made of high quality, rugged fabric. Set Up is easy and quickly. Also, its adjustable legs allow to adjust the height of the tent. It is often seen at outdoor events, indoor trade shows, large-scale public events or family parties. Spikes, ropes and a travel case with wheels are included.

STEEL 2x2	PROFILE	QTY	N.W	G.W	C.B.M	SIZE
10.181		1	13kg	15kg	0.07	1340x230x230mm
10.182		1	13kg	15kg	0.07	1340x230x230mm
10.183		1	13kg	15kg	0.07	1340x230x230mm
2000x2000mm						

## 2x2 STEEL TENT



## TENT DETAILS

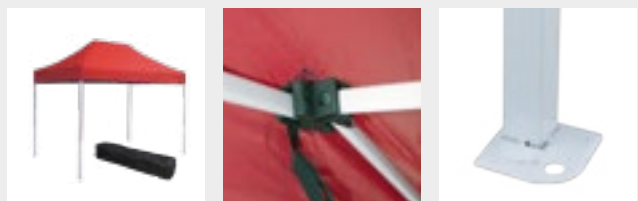

## DIMENSIONS

\*mm

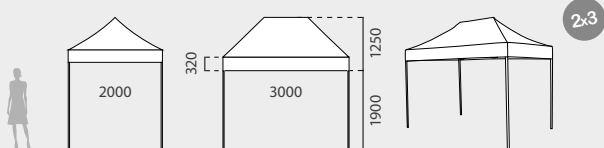

## INFORMATION

This 2x3 portable tent features a steel truss frame and a cover top made of high quality, rugged fabric. Set Up is easy and quickly. Also, its adjustable legs allow to adjust the height of the tent. It is often seen at outdoor events, indoor trade shows, large-scale public events or family parties. Spikes, ropes and a travel case with wheels are included.

STEEL 2x3	PROFILE	QTY	N.W	G.W	C.B.M	SIZE
10.184		1	17kg	19kg	0.1	1340x250x300mm
10.185		1	17kg	19kg	0.1	1340x250x300mm
10.186		1	17kg	19kg	0.1	1340x250x300mm
2000x3000mm						

## 2x3 STEEL TENT



\* flag banner and counter are not included

TENT DETAILS

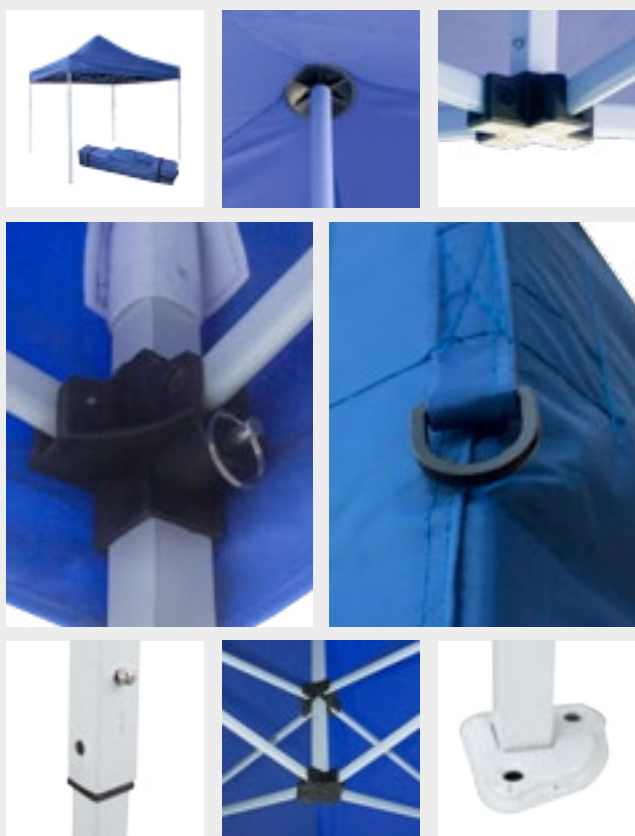

DIMENSIONS

\*mm

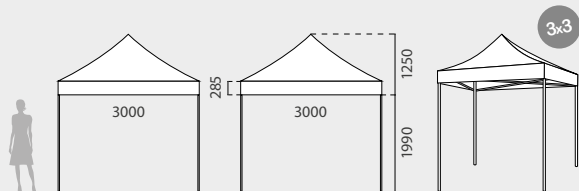

INFORMATION

This 3x3 portable tent features a steel stable truss frame and a cover top made of high quality, rugged fabric available in 3 colors (Royal blue, White or Red). This pop up tent provides shade, shelter, and advertising space at promotional events. Have an instant shade option in seconds after quickly raising the frame and clicking it into position with its spring-loaded locks (no Tools Required). Also, thanks to its adjustable legs, you can adjust the height of the tent (3 different height settings). Ground spikes and ropes are included in the package to be used in case of light winds at outdoor events. Also, for a simple and fast transportation, a travel case with wheels is included. It is often seen at outdoor events, indoor trade shows, large-scale public events, flea markets, outdoor parties, concerts, festivals or a family party.

STEEL 3x3	PROFILE	QTY	N.W	G.W	C.B.M	SIZE
10.187		1	19kg	21kg	0.09	1570x230x260mm
10.188		1	19kg	21kg	0.09	1570x230x260mm
10.189		1	19kg	21kg	0.09	1570x230x260mm

3000x3000mm

3x3 STEEL TENT



## TENT DETAILS



## DIMENSIONS

\*mm

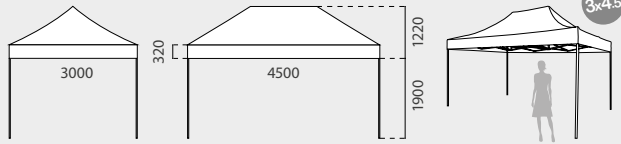

## INFORMATION

This 3x4.5 portable tent features a steel truss frame and a cover top made of high quality, rugged fabric. Set Up is easy and quickly. Also, its adjustable legs allow to adjust the height of the tent. It is often seen at outdoor events, indoor trade shows, large-scale public events or family parties. Spikes, ropes and a travel case with wheels are included.

STEEL 3x4.5	PROFILE	QTY	N.W	G.W	C.B.M	SIZE
10.190		1	24kg	26kg	0.1	1570x250x270mm
10.220		1	24kg	26kg	0.1	1570x250x270mm
10.250		1	24kg	26kg	0.1	1570x250x270mm
3000x4500mm						

## 3x4.5 STEEL TENT



**Blackboard**  
ref 14.112

+info at  
chap 2

## TENT DETAILS



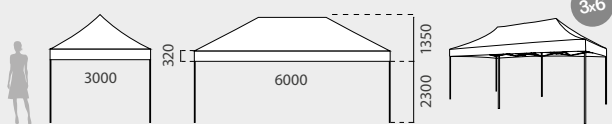

## DIMENSIONS

\*mm



## INFORMATION

This 3x6 portable tent has the biggest size available, featuring a steel truss frame and a cover top made of high quality, rugged fabric. Set Up is easy and quickly. Also, its adjustable legs allow to adjust the height of the tent. It is often seen at outdoor events, indoor trade shows, large-scale public events or family parties. Spikes, ropes and a travel case with wheels are included.

STEEL 3x6	PROFILE	QTY	N.W	G.W	C.B.M	SIZE
10.251		1	37kg	39kg	0.16	1570x260x400mm
10.252		1	37kg	39kg	0.16	1570x260x400mm
10.253		1	37kg	39kg	0.16	1570x260x400mm
3000x6000mm						

## 3x6 STEEL TENT



**Flag**  
ref 13.601

+info at  
chap 3



TENT DETAILS



WALL OPTIONS

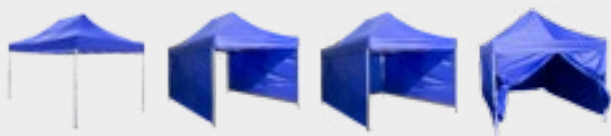

DIMENSIONS

\*mm

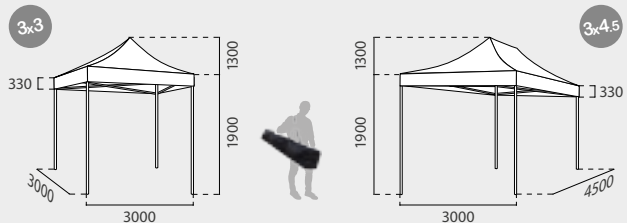

INFORMATION

This portable tent features an aluminium truss frame and a cover top made of high quality blue fabric. Have an instant shade option in seconds after quickly raising the frame and clicking it into position with its spring-loaded locks. Also, featuring height adjustable legs and 4 walls to customize tent with various configurations. Ideal for outdoor events, trade shows, outdoor markets, public events or a family party. Spikes, ropes and a travel case with wheels are included.

A. TENT 3x3	PROFILE	QTY	N.W	G.W	C.B.M	SIZE
10.433		1	13kg	15kg	0.075	1550x220x220mm
3000x3000mm						
A.TENT 3x4.5	PROFILE	QTY	N.W	G.W	C.B.M	SIZE
10.434		1	17kg	19kg	0.096	1550x250x250mm
3000x4500mm						

ALUMINIUM TENT



BASE DETAILS



INFORMATION

\*mm

This square black steel base is suitable for being used with the tents of this chapter, thanks to its design is suitable for placing together to the profiles, also it is stackable for a better storage and it has an ergonomic handle space for an easy transport with one hand. This base weighs 7kg.

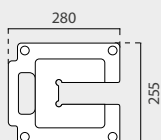

TENT BASE	QTY	N.W	G.W	C.B.M	SIZE
Packing	1	14kg	14.5kg	0.0032	200x200x80mm
15.262		280x255mm		x2 	

TENT BASE 7kg



BASE DETAILS



INFORMATION

\*mm

This round black steel base is ideal for being used with the tents of this catalogue, thanks to its design is suitable for placing together to the profiles and it is stackable for a better storage. Also it has 2 spaces for fixing to the ground and an ergonomic handle space for an easy transport with one hand. It weighs 10kg.

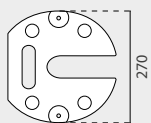

TENT BASE	QTY	N.W	G.W	C.B.M	SIZE
Packing	1	10kg	10.5kg	0.003	280x280x45mm
10.254			Ø 270mm		

TENT BASE 10kg



GATE DETAILS



DIMENSIONS

\*mm

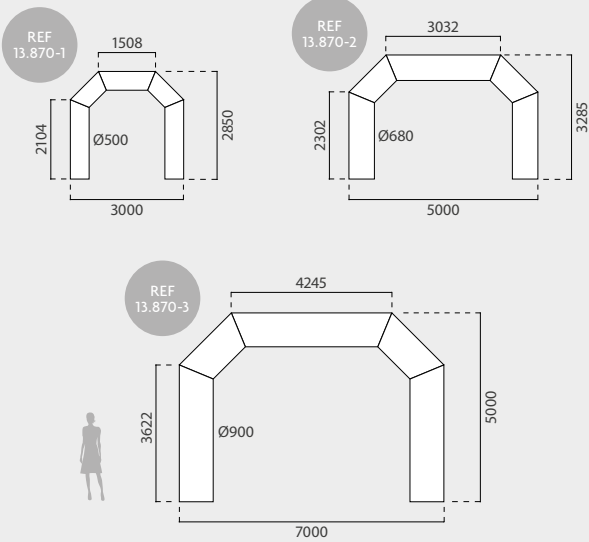

INFORMATION

Inflatable Gate is available in 3 diferetns sizes. These innovative inflatable arches are very similar to traditional ones but it has better weather resistance, better stability, no collapse risk and no blower noise. Moveover, offers big space for branding. The advantages of these inflatable arches are the compactness for transportation and easy installation. These gates are primarily used at sport events, opening of stores or private parties.

GATE		WIDTH
13.870-1	<input type="checkbox"/>	3000m
13.870-2	<input type="checkbox"/>	5000m
13.870-3	<input type="checkbox"/>	7000m

INFLATABLE GATE



\* graphics not included but available under request.



COLUMN DETAILS



DIMENSIONS

ARTWORK

\*mm

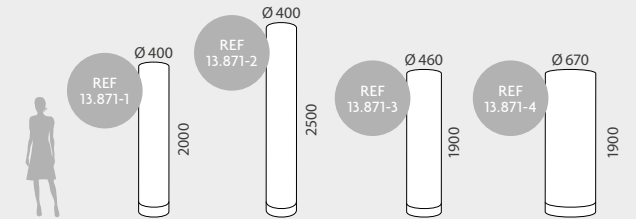

INFORMATION

The Inflatable Column doesn't need electrical fan motor which pumps air continuously, thanks to its separate inflate and deflate nozzles just needs a few minutes to this task. Base with 4 rings for fixing to the floor. There are 4 available sizes. This column can be used in interior or exterior places. Also, you can customize it with your own graphic (printing available but not included).

COLUMN	SIZE
13.871-1 <input type="checkbox"/>	Ø400x2000mm
13.871-2 <input type="checkbox"/>	Ø400x2500mm
13.871-3 <input type="checkbox"/>	Ø460x1900mm
13.871-4 <input type="checkbox"/>	Ø670x1900mm

INFLATABLE COLUMN



MANUAL PUMP



PUMP DETAILS

INFORMATION

\*mm

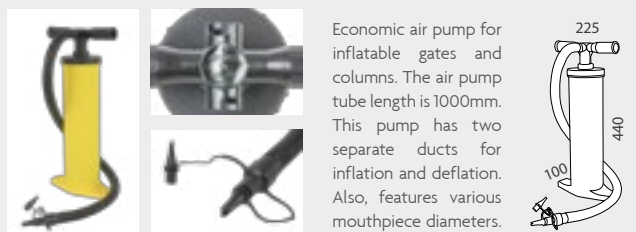

Economic air pump for inflatable gates and columns. The air pump tube length is 1000mm. This pump has two separate ducts for inflation and deflation. Also, features various mouthpiece diameters.

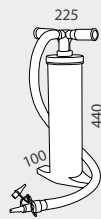

MAN. INFLAT.	SIZE
13.872	225x440x100mm

ELECTRIC PUMP



PUMP DETAILS

INFORMATION

\*mm

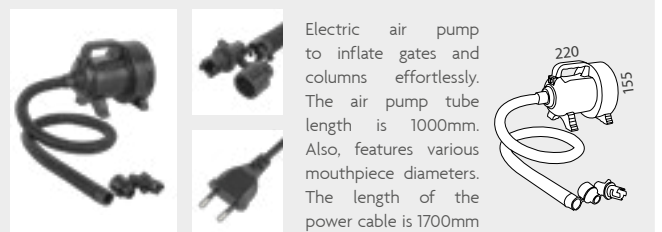

Electric air pump to inflate gates and columns effortlessly. The air pump tube length is 1000mm. Also, features various mouthpiece diameters. The length of the power cable is 1700mm

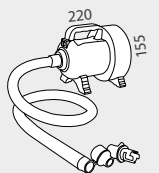

ELEC. INFLAT.	SIZE
13.873	220x155x155mm

\* graphics not included but available under request.

DANCER DETAILS



INFORMATION

\*mm

The inflatable air dancer is 6m high and features two colors. It is lightweight and easy to handle. A carry bag is included for an easy and fast transport. Ideal to achieve great visual impact thanks to its constant motion. Featuring an electrical fan motor wich pumps air continuously. The Air Dancer is designed to help increase the visibility of your establishment, highlight promotions and public campaigns, increase foot traffic and help to promote any special event.

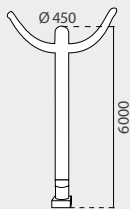

- 15.152
- 15.154

Ø 450x6000mm

AIR DANCER



6m



TENT DETAILS



DIMENSIONS \*mm

2.9m high

supplied with accessories



INFORMATION

This inflatable Tent with removable sides includes an air motor and features advertising customized publicity spaces at fronts. It is supplied with accessories. Fast and easy to assemble. This inflatable tent/dome features 4 removal walls thanks to its sides zippers. With 2 colors available (white or red) and a transport bag included for an easy transport. Ideal for promotional events at squares, sports arenas, playing centers, festivals or just for family parties at gardens or parks.

15.158	<input type="checkbox"/>	
15.159	<input checked="" type="checkbox"/>	
4250x4250x2900mm		

INFLATABLE TENT



Golf Banner  
ref 10428

Flag  
ref 13607

\* graphics not included but available under request.

TENT DETAILS

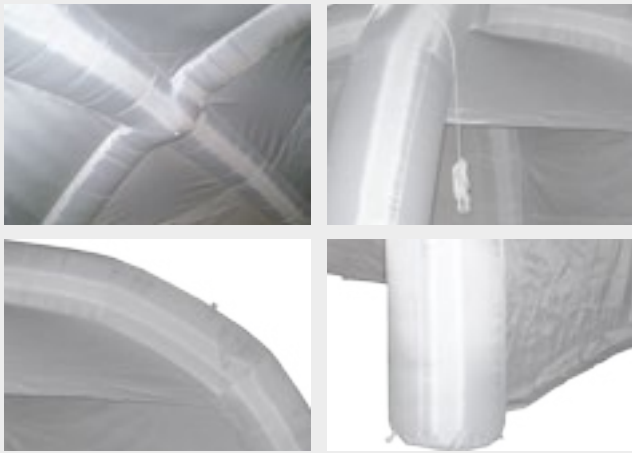

DIMENSIONS \*mm

2.9m high

supplied with several accessories

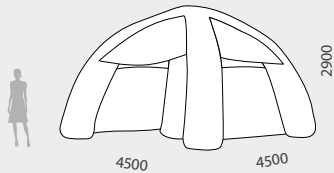

INFORMATION

This inflatable Auditorium includes an air motor and features advertising customized publicity spaces at fronts. It is supplied with accessories. Fast and easy to assemble. This inflatable tent/dome features 4 removal walls thanks to its sides zippers. With 2 colors available (white or red) and a transport bag included for an easy transport. Ideal for promotional events at squares, sports arenas, playing centers, festivals or just for family parties at gardens or parks.

15.169

4500x4500x2900mm

INFLATABLE AUDITORIUM TENT



## STAND DETAILS





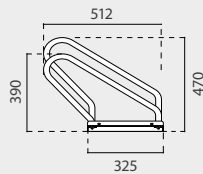

## INFORMATION

\*mm

Carlow Bike Support is made of steel with a galvanized finish on RAL 9006 Grey, so it is weatherproof and resistant to the corrosion. Featuring 5 sizes available, and designed for 2-7 bike. Ideal for outdoor expositions, mall entrances or retail stores.



CARLOW	LENGTH	PLACES	
10.705	700mm	2 Places	
10.706	1050mm	3 Places	
10.762	1750mm	5 Places	
10.782	2100mm	6 Places	
10.933	2450mm	7 Places	

## CARLOW



## STAND DETAILS



## INFORMATION

\*mm

Wexford Bike Support is made of steel with a galvanized finish on RAL 9006 Grey, so it is weatherproof and resistant to the corrosion. Featuring a double-sided frame. It is designed for a maximum of 6 bikes. Wexford Bike Support is ideal for outdoor expositions, mall entrances or retail stores.

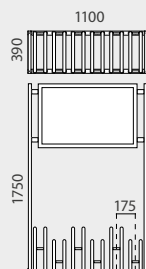

WEXFORD	GRAPHIC SIZE	PLACES
10.809	A1	6 Places

## WEXFORD





# INFO HOLDERS & FRAMES 06

Complete range of frames and info holders which provide an integral solution for the exhibition at promotional events, stores or business presentations.

- 212** CLICK FRAMES
- 223** SLIDE-IN FRAMES
- 224** FRAME FOR BOARDS
- 225** CLICK LIGHT FRAMES
- 229** TABLET STANDS
- 236** LECTERN STANDS
- 242** CLICK STANDS
- 251** INFO TOTEMS
- 260** LITERATURE STANDS
- 272** BROCHURE HOLDERS
- 287** BALLOT BOXES





FRAME DETAILS



INFORMATION

\* W: Width H: Height D: Depth \*mm

click

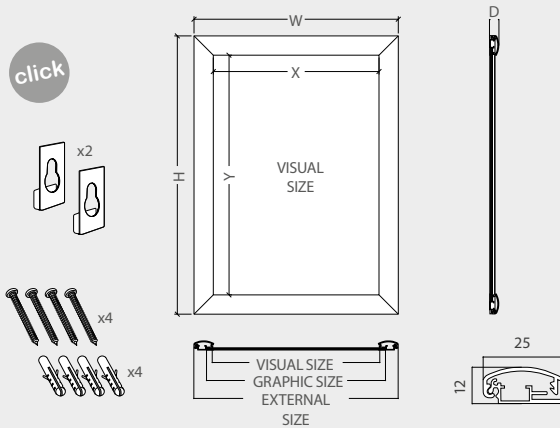

The Maracay frame is economically priced because the profile is thinner and lightweight than other frames. Once this display is wall mounted though there is virtually no difference. Perfect for restaurants, retail stores, community centers, theatres, airports, supermarkets. Anti-reflective cover and screws included.

MARACAY

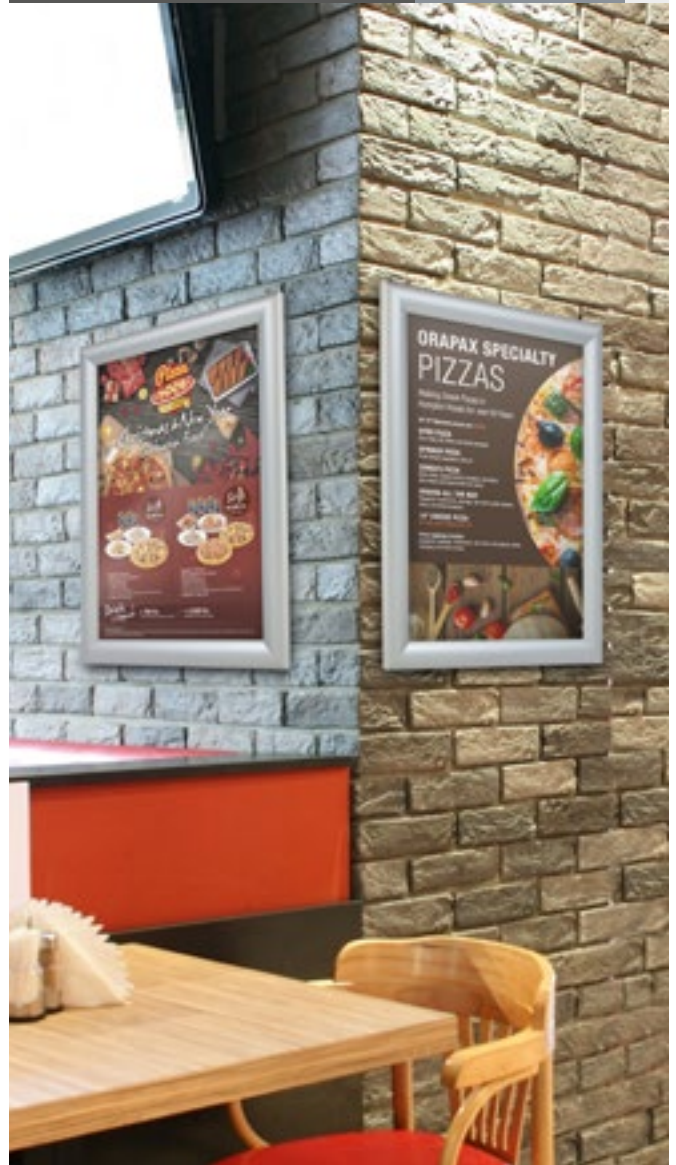

**MARACAY A4** W: Width H: Height D: Depth \*mm

	QTY	N.W	G.W	C.B.M	Size (WxHxD)
Packing	10	0.4kg	5.1kg	0.0205	355x210x275
		Visual (X-Y)	External (WxHxD)		
Product		196x282	246x332x13		
14.124					Graphic Size: A4

**MARACAY A3** W: Width H: Height D: Depth \*mm

	QTY	N.W	G.W	C.B.M	Size (WxHxD)
Packing	10	0.57kg	8.2kg	0.0363	480x210x360
		Visual (X-Y)	External (WxHxD)		
Product		284x409	334x507x13		
14.123					Graphic Size: A3

**MARACAY A2** W: Width H: Height D: Depth \*mm

	QTY	N.W	G.W	C.B.M	Size (WxHxD)
Packing	10	0.91kg	13.2kg	0.0672	660x210x485
		Visual (X-Y)	External (WxHxD)		
Product		406x587	456x637x13		
14.122					Graphic Size: A2

**MARACAY A1** W: Width H: Height D: Depth \*mm

	QTY	N.W	G.W	C.B.M	Size (WxHxD)
Packing	5	1.5kg	11.7kg	0.0726	910x120x665
		Visual (X-Y)	External (WxHxD)		
Product		587x838	637x888x13		
14.121					Graphic Size: A1

**MARACAY H700** W: Width H: Height D: Depth \*mm

	QTY	N.W	G.W	C.B.M	Size (WxHxD)
Packing	10	1.22kg	14.7kg	0.0910	760x210x570
		Visual (X-Y)	External (WxHxD)		
Product		488x694	538x744x13		
14.126					Graphic: 500x700mm

**MARACAY H1000** W: Width H: Height D: Depth \*mm

	QTY	N.W	G.W	C.B.M	Size (WxHxD)
Packing	5	1.7kg	12.9kg	0.0979	1060x120x770
		Visual (X-Y)	External (WxHxD)		
Product		693x986	743x1036x13		
14.125					Graphic: 700x1000mm

FRAME DETAILS



INFORMATION

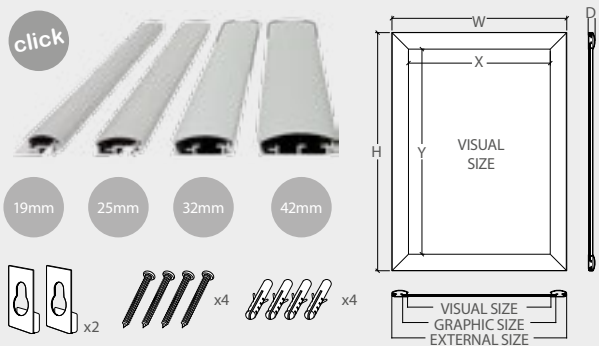

\* W: Width H: Height D: Depth \*mm



The Anadia frame is constructed from anodized aluminum with a matte silver finish. It features Click spring-loaded action, so updating a presentation takes only a few seconds. It includes screws and hangers for wall mounting. This frame is perfect for restaurants, retail stores, movie theatres, airports, malls, banks or for any other location requiring a frequent change of the graphics.

ANADIA

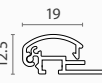
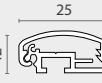

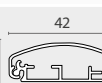
ANADIA					* W: Width H: Height D: Depth *mm				
Ref.	Graphic Size	Visual (X-Y)	External (WxHxD)	Profile	Packing (QTY)	N.W	G.W	C.B.M	Size (WxHxD)
10.314	A4	199x286	237x324x12.50		1	0.4kg	0.5kg	0.024	270x350x25
10.315	A3	286x409	324x477x12.50		1	0.7kg	0.85kg	0.0061	365x480x35
10.316	A2	409x583	447x621x12.50		1	1kg	1.3kg	0.0067	475x645x22
10.317	500x700	489x689	527x727x12.50		1	1.3kg	1.7kg	0.0104	560x745x25
10.214	A4	190x278	242x329x12		1	0.45kg	0.55kg	0.0024	270x350x25
10.213	A3	278x401	329x452x12		1	0.65kg	0.85kg	0.0061	365x480x35
10.212	A2	401x575	452x626x12		1	1.05kg	1.35kg	0.0067	475x645x22
10.215	500x700	480x680	532x732x12		1	1.4kg	1.8kg	0.0104	560x745x25
10.290	A3	275x398	339x462x13.3		1	0.8kg	1.05kg	0.0061	365x480x35
10.291	A2	398x572	462x636x13.3		1	1.2kg	1.6kg	0.0067	475x645x22
10.292	A1	572x819	663x884x13.3		1	2kg	2.45kg	0.0143	645x886x25
10.293	500x700	478x678	542x742x13.3		1	1.5kg	2kg	0.0104	560x745x25
10.294	700x1000	678x978	742x1042x13.3	1	2.55kg	3.25kg	0.0197	1075x780x25	
10.296	A0	821x1169	905x1253x14.5		1	4kg	5.04kg	0.0291	1265x920x25
10.295	700x1000	680x980	764x1064x14.5		1	3kg	3.75kg	0.0197	1075x780x25
10.297	1000x1400	980x1380	1064x1464x14.5		1	5.55kg	6.7kg	0.0398	1475x1080x25

FRAME DETAILS



ANADIA  
DOUBLE-SIDED



INFORMATION

\* W: Width H: Height D: Depth

click



42mm

32mm

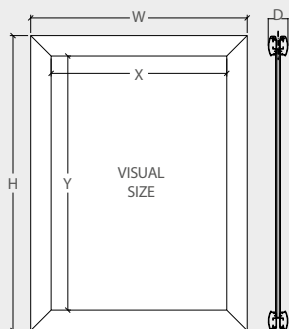



The Double-sided Anadia frame is constructed from aluminum and has a matte silver finish. It can be mounted vertically or horizontally, depending on your sign or advertisement. We supply this frame with the necessary screws and hangers for hanging. Insert your posters or graphics on top of the back panel, replace the lens and flip the sides down. This frame features 2 ways visibility, increasing advertisement exposure. Ideal for hanging in a storefront window or from the ceiling allow for placement overhead, in a central location.

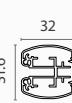

ANADIA DOUBLE-SIDED

\* W: Width H: Height D: Depth \*mm

Ref.	Graphic Size	Visual (X-Y)	External (WxHxD)	Profile	Packing (QTY)	N.W	G.W	C.B.M	Size (WxHxD)
10.299	A3	283x406	347x470x31.6		1	1.25kg	1.6kg	0.0061	480x365x35
10.300	A2	406x580	470x664x31.6		1	1.85kg	2.15kg	0.0127	485x655x40
10.302	A1	580x827	644x891x31.6		1	2.8kg	3.25kg	0.0235	660x890x40
10.303	500x700	486x686	550x750x31.6		1	2.3kg	2.8kg	0.0172	565x760x40
10.562	A0	807x1155	891x1239x33.9		1	4.7kg	6.2kg	0.0430	905x1250x38
10.566	700x1000	666x966	750x1050x33.9		1	4kg	4.85kg	0.0323	765x1055x40

FRAME DETAILS



LIMA



INFORMATION

\* W: Width H: Height D: Depth

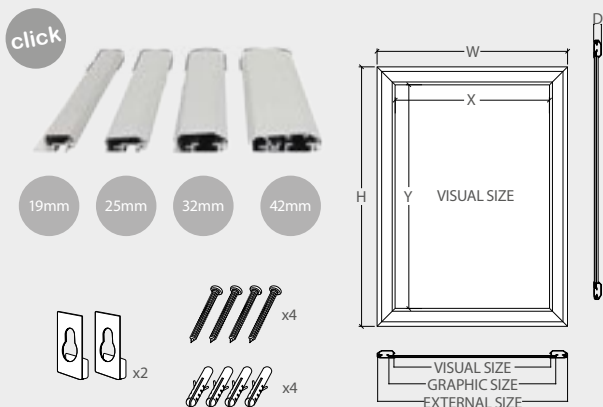





The Lima frame is constructed from anodized aluminum with a matte silver finish. It features Click spring-loaded action, so updating a presentation takes only a few seconds. It can be mounted vertically or horizontally and it includes screws and hangers for wall mounting. This frame is perfect for restaurants, retail stores, movie theatres, airports, malls, banks or for any other location requiring a frequent change of the graphics.



LIMA

\* W: Width H: Height D: Depth \*mm

Ref.	Graphic Size	Visual (X-Y)	External (WxHxD)	Profile	Packing (QTY)	N.W	G.W	C.B.M	Size (WxHxD)
10.210	A4	199x286	237x324x11.95		1	0.4kg	0.5kg	0.0024	270x350x25
10.209	A3	286x409	324x477x11.95		1	0.7kg	0.85kg	0.0061	365x480x35
10.208	A2	409x583	447x621x11.95		1	1kg	1.3kg	0.0067	475x645x22
10.211	500x700	489x689	527x727x11.95		1	1.3kg	1.7kg	0.0104	560x745x25
10.260	A4	190x278	242x329x11.5		1	0.45kg	0.55kg	0.0024	270x350x25
10.259	A3	278x401	329x452x11.5		1	0.65kg	0.85kg	0.0061	365x480x35
10.258	A2	401x575	452x626x11.5		1	1.05kg	1.35kg	0.0067	475x645x22
10.261	500x700	480x680	532x732x11.5		1	1.4kg	1.8kg	0.0104	560x745x25
10.262	A3	275x398	339x462x13.75		1	0.8kg	1.05kg	0.0061	365x480x35
10.263	A2	398x572	462x636x13.75		1	1.2kg	1.6kg	0.0067	475x645x22
10.264	A1	572x819	663x884x13.75		1	2kg	2.45kg	0.0143	645x886x25
10.266	500x700	478x678	542x742x13.75		1	1.5kg	2kg	0.0104	560x745x25
10.267	700x1000	678x978	742x1042x13.75	1	2.6kg	3.5kg	0.0197	1075x780x25	
10.270	A0	821x1169	905x1253x13.75		1	4kg	5.04kg	0.0291	1265x920x25
10.272	700x1000	680x980	764x1064x13.75		1	3kg	3.75kg	0.0197	1075x780x25
10.268	1000x1400	980x1380	1064x1464x13.75		1	5.5kg	6.7kg	0.0398	1475x1080x25

FRAME DETAILS



INFORMATION

\* W: Width H: Height D: Depth

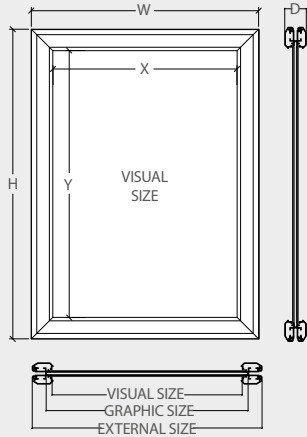



The Double-sided Lima frame is constructed from aluminum and has a matte silver finish. It can be mounted vertically or horizontally, depending on your sign or advertisement. We supply this frame with the necessary screws and hangers for hanging. Insert your posters or graphics on top of the back panel, replace the lens and flip the sides down. This frame features 2 ways visibility, increasing advertisement exposure. Ideal for hanging in a storefront window or from the ceiling allow for placement overhead, in a central location.

LIMA  
DOUBLE-SIDED

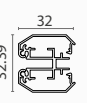

LIMA DOUBLE-SIDED

\* W: Width H: Height D: Depth \*mm

Ref.	Graphic Size	Visual (X-Y)	External (WxHxD)	Profile	Packing (QTY)	N.W	G.W	C.B.M	Size (WxHxD)
10.563	A3	283x406	347x470x32.39		1	1.25kg	1.6kg	0.0061	480x365x35
10.564	A2	406x580	470x664x32.39		1	1.85kg	2.15kg	0.0127	485x655x40
10.565	A1	580x827	644x891x32.39		1	2.8kg	3.25kg	0.0235	660x890x40
10.289	500x700	486x686	550x750x32.39		1	2.3kg	2.8kg	0.0172	565x760x40
10.257	A0	807x1155	891x1239x32.39		1	4.7kg	6.2kg	0.0430	905x1250x38
10.560	700x1000	666x966	750x1050x32.39		1	4kg	4.85kg	0.0323	765x1055x40

FRAME DETAILS



INFORMATION

\* W: Width H: Height D: Depth

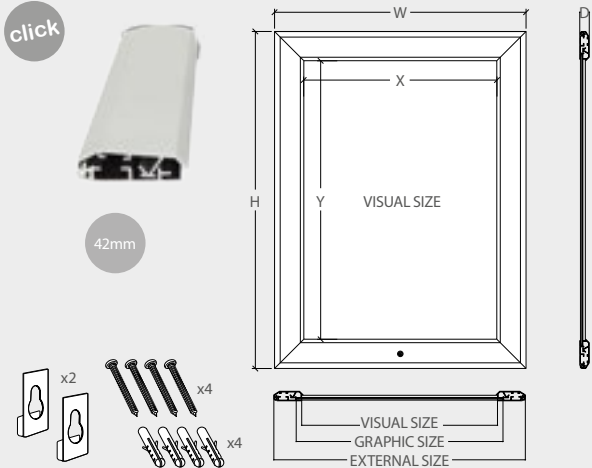

The Lima frame is constructed from anodized aluminum with a matte silver finish and it features a front-loading frame which can be secured shut with an Allen key to keep posters protected. It can be mounted vertically or horizontally. Screws and allen key wrench included. This frame is perfect for being used in restaurants, retail stores, community centers, movie theatres, airports, banks or any other location requiring frequent changes of advertisements.

LIMA  
LOCKABLE

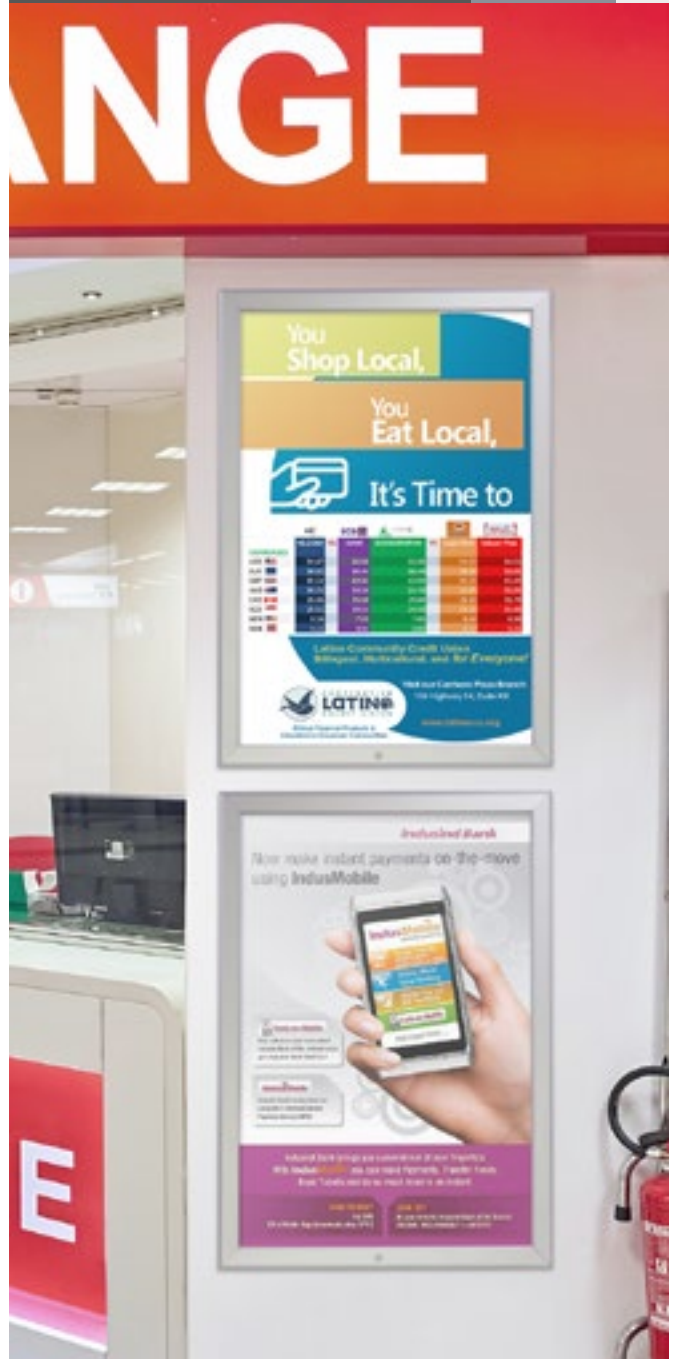

LIMA LOCKABLE

\* W: Width H: Height D: Depth \*mm

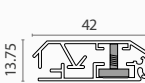
Ref.	Graphic Size	Visual (X-Y)	External (WxHxD)	Profile	Packing (QTY)	N.W	G.W	C.B.M	Size (WxHxD)
10.280	A1	574x821	658x905x13.75		1	2.3kg	3.1kg	0.0153	672x912x25
10.281	A0	821x1169	905x1253x13.75		1	4kg	5.04kg	0.0291	1265x920x65
10.282	500x700	480x680	564x764x13.75		1	1.8kg	2.35kg	0.0112	580x771x25
10.283	700x1000	680x980	764x1064x13.75		1	3kg	3.75kg	0.0191	1075x780x25
10.278	1000x1400	980x1380	1064x1464x13.75		1	5.55kg	6.7kg	0.0398	1475x1080x25

FRAME DETAILS



LIMA  
WATERPROOF



INFORMATION

\* W: Width H: Height D: Depth

click



42mm

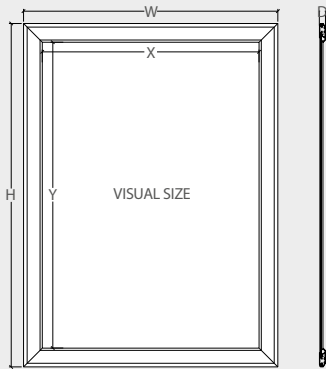
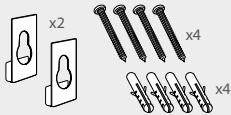

This Lima frame is constructed from anodized durable aluminum with a matte silver finish. It is waterproof, rust proof and it includes an anti-reflective plastic cover, protective overlay to prevent glare. Screws and hangers are included. This frame is perfect for being used in restaurants, retail stores, community centers, movie theatres, airports, banks or any other outdoor location requiring frequent changes of advertisements.



LIMA WATERPROOF

\* W: Width H: Height D: Depth \*mm

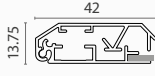
Ref.	Graphic Size	Visual (X-Y)	External (WxHxD)	Profile	Packing (QTY)	N.W	G.W	C.B.M	Size (WxHxD)
10.285	A1	580x827	664x911x13.75		1	2kg	2.5kg	0.0153	672x912x25
10.286	A0	827x1175	911x1259x13.75		1	4kg	5.04kg	0.0291	1265x920x25
10.287	500x700	486x686	570x770x13.75		1	1.65kg	2.01kg	0.0104	560x745x25
10.288	700x1000	686x986	770x1070x13.75		1	3.05kg	3.48kg	0.0191	1075x780x25
10.561	1000x1400	986x1386	1070x1470x13.75		1	5.55kg	6.7kg	0.0398	1475x1080x25



FRAME DETAILS



INFORMATION

\* W: Width H: Height D: Depth \*mm

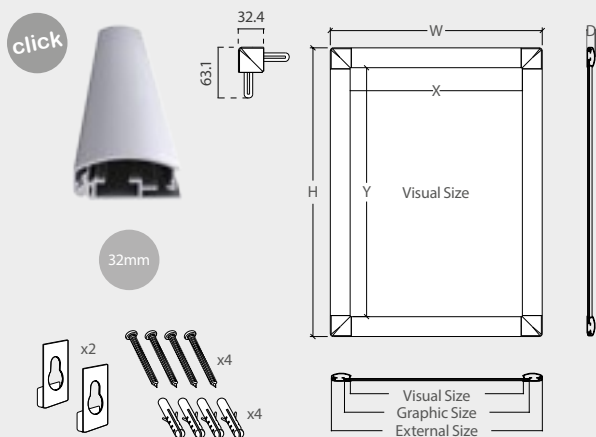

The Serena anodized aluminum frame features a stylish bicolor design. It has a 32mm width profile which features Click closing system. Graphics change takes only a few seconds. Due to its elegant appearance the single-sided frame Serena is ideal for restaurants, hotels, theatres, offices, malls or any other location requiring a distinctive look on the frames or a frequent changes of posters. Also, protective anti-reflection cover, screws and hangers are included.

SERENA



SERENA

\* W: Width H: Height D: Depth \*mm

Ref.	Graphic Size	Visual (X-Y)	External (WxHxD)	Profile	Packing (QTY)	N.W	G.W	C.B.M	Size (WxHxD)
10.405	A4	188x275	252x339x13.35		1	0.4kg	0.5kg	0.0024	270x25x350
10.404	A3	275x398	339x462x13.35		1	0.7kg	0.95kg	0.0042	475x22x355
10.403	A2	398x572	462x636x13.35		1	1.05kg	1.45kg	0.0067	475x22x645
10.408	500x700	478x678	542x742x13.35		1	1.35kg	1.85kg	0.0104	560x25x745
10.163	700x1000	678x978	742x1042x13.35		1	2.35kg	3.05kg	0.0197	1075x25x780

FRAME DETAILS

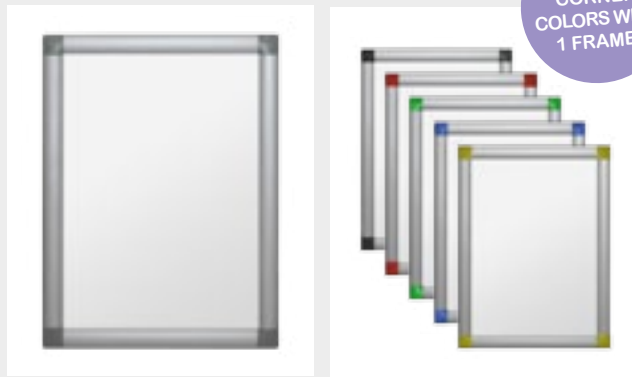

GET 6 CORNER COLORS WITH 1 FRAME!

INCLUDES 4 GREY CORNERS AND 20 COLORED COVERS



INFORMATION

\* W: Width H: Height D: Depth \*mm

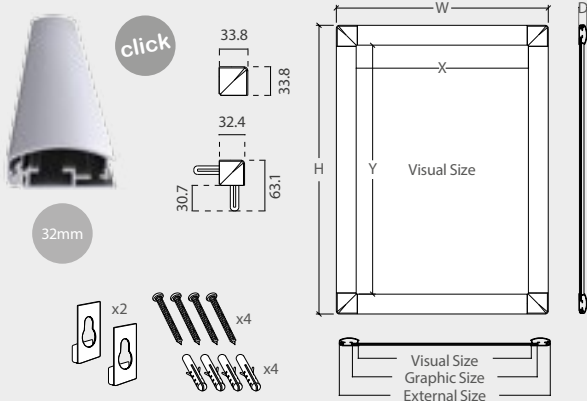

The Rainbow aluminum frame features 4 grey corners + 20 colored covers. It has a 32mm width profile which features click closing system. Insert your graphics on top of the back panel, replace the lens, and flip the sides down to hold everything in place, so updating a presentation takes only a few seconds. It can be mounted vertically or horizontally. Featuring 5 standard sizes available. Due to its versatile design the single-sided frame Rainbow is ideal for restaurants, hotels, theatres, offices, malls or any other location requiring a distinctive look on the frames or a frequent changes of posters. Also, Protective anti-reflection cover, screws and hangers are included.

RAINBOW FRAME



RAINBOW

\* W: Width H: Height D: Depth \*mm

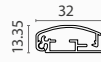
Ref.	Graphic Size	Visual (X-Y)	External (WxHxD)	Profile	Packing (QTY)	N.W	G.W	C.B.M	Size (WxHxD)
13.590	A4	188x275	252x339x13.35		1	0.4kg	0.5kg	0.0024	270x25x350
13.591	A3	275x398	339x462x13.35		1	0.7kg	0.95kg	0.0042	475x22x355
13.592	A2	398x572	462x636x13.35		1	1.05kg	1.45kg	0.0067	475x22x645
13.593	500x700	478x678	542x742x13.35		1	1.35kg	1.85kg	0.0104	560x25x745
13.754	700x1000	678x978	742x1042x13.35		1	2.35kg	3.05kg	0.0197	1075x25x780

FRAME DETAILS



ISCAR  
COVER FRAME



DIMENSIONS

\* W: Width H: Height D: Depth

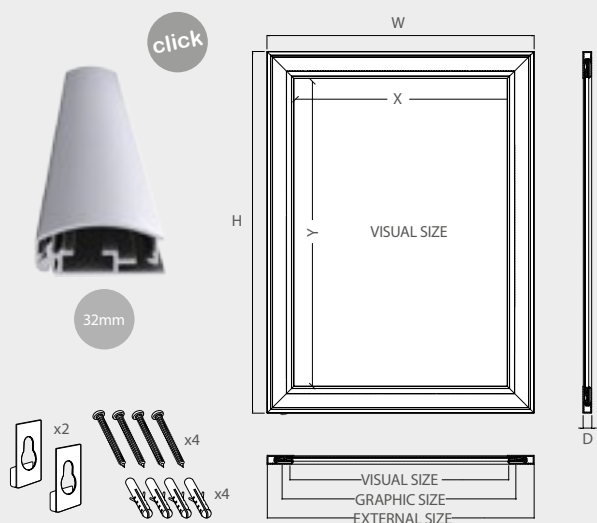

INFORMATION

The Iscar aluminum frame features a stylish design with double-framed appearance. It has a 34.9mm width profile which features click closing system so updating a presentation takes only a few seconds. It can be mounted vertically or horizontally. Featuring 5 standard sizes available. Due to its elegant appearance the double-sided frame Iscar is ideal for restaurants, hotels, theatres, offices, malls or any other location requiring a distinctive look on the frames or a frequent changes of posters. Also, Protective anti-reflection cover, screws and hangers are included.



ISCAR

\* W: Width H: Height D: Depth \*mm

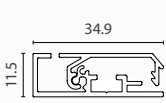
Ref.	Graphic Size	Visual (X-Y)	External (WxHxD)	Profile	Packing (QTY)	N.W	G.W	C. B. M	Size (WxHxD)
13.635	A3	278.2x401	346x471x11.5		1	1.04kg	1.19kg	0.0044	485x365x25
13.636	A2	401x575	471x645x11.5		1	1.52kg	1.78kg	0.0080	660x485x25
13.637	A1	575x822	645x892x11.5		1	2.34kg	2.78kg	0.0149	905x660x25
13.638	500x700mm	461x681	551x751x11.5		1	1.87kg	2.20kg	0.0108	765x565x25
13.639	700x1000mm	681x981	751x1051x11.5		1	2.95kg	3.54kg	0.0204	1065x765x25

FRAME DETAILS



ADDITIONAL COLORS UPON REQUEST

The Trujillo aluminum Click frame is available in more colors upon request\*.



INFORMATION

\* W: Width H: Height D: Depth \*mm

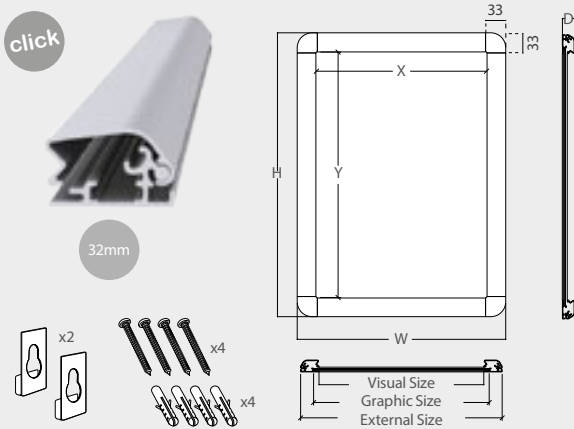

Trujillo aluminum frame features a stylish bicolor design with rounded corners. It can be mounted vertically or horizontally and updating a poster takes only a few seconds. 4 colors available upon request. Ideal for restaurants, markets, malls or any other location requiring frequent changes of posters. Screws and hangers included.

TRUJILLO



TRUJILLO

\* W: Width H: Height D: Depth \*mm



Ref.	Graphic Size	Visual (X-Y)	External (WxHxD)	Profile	Packing (QTY)	N.W	G.W	C.B.M	Size (WxHxD)
10.130	A4	194.2x281	257x344x20.3		1	0.6kg	0.75	0.0039	360x275x40
10.131	A3	278x402	344x468x20.3		1	1kg	1.2kg	0.0061	365x480x35
10.132	A2	402x575	468x641x20.3		1	1.65kg	2.15kg	0.0127	485x655x40
10.133	A1	575x822	641x888x20.3		1	2.4kg	3.2kg	0.0235	660x890x40
10.134	A0	822x1170	888x1236x20.3		1	4.4kg	5.45kg	0.0430	1250x905x38
10.135	500x700	481x681	547x747x20.3		1	1.95kg	2.4kg	0.0104	560x745x25
10.136	700x1000	681x981	747x1047x20.3		1	3.25kg	4kg	0.0323	765x1055x40

FRAME DETAILS



DIMENSIONS

\* W: Width H: Height D: Depth

Lublin aluminum frame has an open profile on one of its narrow sides. The change of graphic is really fast and easy, just insert your poster or graphic through the groove on the narrower side (W) of the Lublin frame, so this way, updating a presentation takes only a few seconds.

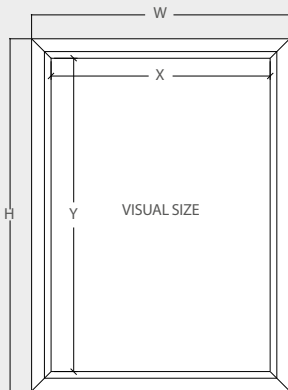

INFORMATION





Lublin frame is made of anodized aluminium. This aluminum is lightweight but durable and can be hung either vertically or horizontally as well. The antireflection plastic cover protects the graphics from tampering. Also, the screws and hangers for wall mounting are included. Lublin frame is ideal for restaurants, supermarkets, banks, movies theatres, airports, malls, offices, lobby, at home or any other location requiring frequent changes of posters.

LUBLIN



LUBLIN

\* W: Width H: Height D: Depth \*mm

Ref.	Graphic Size	Visual (X-Y)	External (WxHxD)	Profile	Packing (QTY)	N.W	G.W	C.B.M	Size (WxHxD)
10.594	A4	203x288	233x318x11		1	0.3kg	0.4kg	0.0020	325x245x25
10.593	A3	290x411	320x441x11		1	0.5kg	0.65kg	0.0037	450x332x25
10.588	A2	454x626	404x576x15		1	1kg	1.3kg	0.0074	633x466x25
10.587	A1	628x872	578x822x15		1	1.7kg	2.25kg	0.0135	880x640x24

## FRAME DETAILS



## DIMENSIONS

\* W: Width H: Height D: Depth

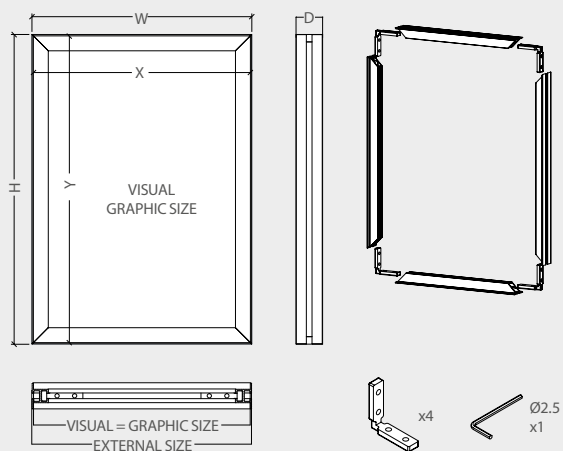

## INFORMATION

\* W: Width H: Height D: Depth

The Tarnow aluminum frame features a silver or a stunning black finished design for being used with foambord graphics. It can be mounted vertically or horizontally and updating a poster is simple and fast. 7 standard sizes are available. Corner connections and Allen key are included. The maximum panel or foam thickness is 5mm. The Tarnow frame is ideal for restaurants, hotels, theatres, offices, malls or any other location requiring a distinctive look on the frames or a frequent changes of posters.

# TARNOW



## TARNOW

\* W: Width H: Height D: Depth \*mm

Ref.	Graphic Size	Visual (X-Y)	External (WxHxD)	Profile	Packing (QTY)	N.W	G.W	C.B.M	Size (WxHxD)	
13.628		A4	297x210	213x300x25.3		1	0.34kg	0.42kg	0.0025	315x230x35
13.629		A3	420x297	300x423x25.3		1	0.45kg	0.58kg	0.0048	435x315x35
13.630		A2	594x420	423x597x25.3		1	0.59kg	0.82kg	0.0094	610x440x35
13.631		A1	841x594	597x844x25.3		1	0.80kg	1.21kg	0.0185	860x615x35
13.632		A0	1189x841	844x1192x25.3		1	1.10kg	1.89kg	0.0309	1025x860x35
13.633		500x700	500x700	503x703x25.3		1	0.69kg	1.01kg	0.0130	715x520x35
13.634		700x1000	700x1000	703x1003x25.3		1	0.93kg	1.5kg	0.0256	1015x720x35

FRAME DETAILS



DIMENSIONS \* W: Width H: Height D: Depth \* mm

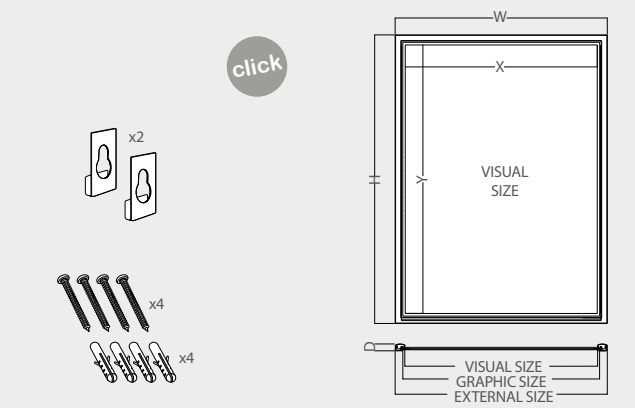

INFORMATION

This hanging light box for daily use combines the power of LED illumination technology with the elegance of a thin profile. The frame on each model is 17.8mm thick, making it one of the slimmest marketing devices currently available. The small LED bulbs in the sides of the window frame prevents against "hot" and "cold" spots appearing on the graphics. Also, the Yucatan Light Box is suitable for wall-mounting.

YUCATAN



YUCATAN					* W: Width	H: Height	D: Depth	*mm	
Ref.	Graphic Size	Visual (X-Y)	External (WxHxD)	Profile	Packing (QTY)	N.W	G.W	C.B.M	Size (WxHxD)
13.207	A0	828x1176	880x1228x17.8		1	7.25kg	10.1kg	0.0737	910x1350x60
13.208	A1	581x828	633x880x17.8		1	3.95kg	5.5kg	0.0398	660x1005x60
13.209	A2	407x581	459x633x17.8		1	2.1kg	3.1kg	0.0222	490x755x60
13.210	A3	284x407	336x459x17.8		1	1.3kg	1.95kg	0.0128	365x585x60
13.211	A4	197x284	249x336x17.8		1	0.8kg	1.2kg	0.0077	280x460x60
13.295	500x700	487x686	539x738x17.8		1	2.85kg	4.1kg	0.0296	570x865x60
13.296	700x1000	687x987	739x1039x17.8	1	5.3kg	7.3kg	0.0538	770x1165x60	

\* Other sizes available upon request / Autres dimension sur demande / Outros tamanhos disponíveis sob consulta / Otros tamaños disponibles bajo pedido.

FRAME DETAILS



DIMENSIONS

\* W: Width H: Height D: Depth \* mm

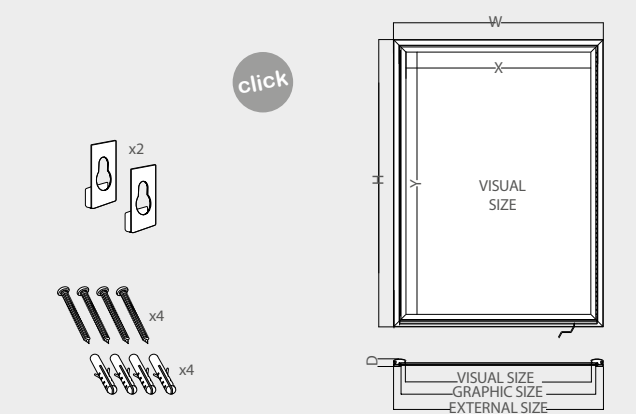

INFORMATION

Artega Light box for daily use combines the power of LED illumination technology with the elegance of a thin anodized aluminium 32mm profile. The frame on each model is 19.75mm thick, making it one of the slimmest marketing devices currently available. The small LED bulbs in the sides of the window prevents against "hot" and "cold" spots appearing on the graphics. Also, the Artega Light Box is suitable for wall-mounting. AC power supply included.

ARTEGA

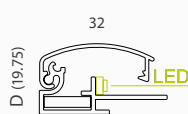

ARTEGA						* W: Width H: Height D: Depth					*mm
Ref.	Graphic Size	Visual (X-Y)	External (WxHxD)	Profile	Packing (QTY)	N.W	G.W	C.B.M	Size (WxHxD)		
13.202	A0	815x1163	880x1228x19.75		1	7.25kg	10.1kg	0.0737	910x1350x60		
13.203	A1	568x815	633x880x19.75		1	3.95kg	5.5kg	0.0398	660x1005x60		
13.204	A2	394x568	459x633x19.75		1	2.1kg	3.1kg	0.0222	490x755x60		
13.205	A3	271x394	336x459x19.75		1	1.3kg	1.95kg	0.0128	365x585x60		
13.206	A4	184x271	249x336x19.75		1	0.8kg	1.2kg	0.0077	280x460x60		
13.293	500x700	474x673	539x738x19.75		1	2.85kg	4.1kg	0.0296	570x865x60		
13.294	700x1000	674x974	739x1039x19.75		1	5.3kg	7.3kg	0.0538	770x1165x60		

\* Other sizes available upon request / Autres dimension sur demande / Outros tamanhos disponíveis sob consulta / Otros tamaños disponibles bajo pedido.



FRAME DETAILS



DIMENSIONS

\* W: Width H: Height D: Depth

click

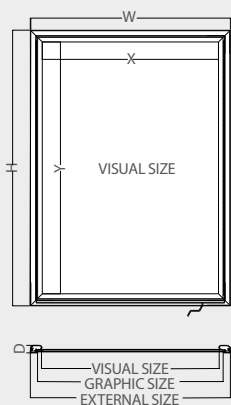
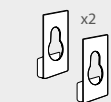

INFORMATION

The Campeche frame display is built from sturdy, durable aluminum frame. With Click System and edge-light LED bulbs, Campeche lightbox stand is useful for darker venues, such as halls and movie theaters. The convex holder helps graphics pop out, ensuring that the double sided poster display can be seen from any angle. Designed for day or night time use, the illuminated lightbox stand has clear PVC lens to prevent glare, while the LED bulbs highlight signage.

CAMPECHE



CAMPECHE

\* W: Width H: Height D: Depth

\*mm

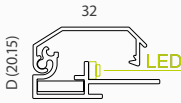
Ref.	Graphic Size	Visual (X-Y)	External (WxHxD)	Profile	Packing (QTY)	N.W	G.W	C.B.M	Size (WxHxD)
13.217	A0	815x163	880x1228x20.15		1	7.25kg	10.1kg	0.0737	910x1350x60
13.218	A1	568x815	633x880x20.15		1	3.95kg	5.5kg	0.0398	660x1005x60
13.219	A2	394x568	459x633x20.15		1	2.1kg	3.1kg	0.0222	490x755x60
13.220	A3	271x394	336x459x20.15		1	1.3kg	1.95kg	0.0128	365x585x60
13.221	A4	184x271	249x336x20.15		1	0.8kg	1.2kg	0.0077	280x460x60
13.291	500x700	474x673	539x738x20.15		1	2.85kg	4.1kg	0.0296	570x865x60
13.292	700x1000	674x974	739x1039x20.15		1	5.3kg	7.3kg	0.0538	770x1165x60

\* Other sizes available upon request / Autres dimension sur demande / Outros tamanhos disponíveis sob consulta / Otros tamaños disponibles bajo pedido.



# NOGALES

## FRAME DETAILS



## DIMENSIONS

\* W: Width H: Height D: Depth



## INFORMATION

The Nogales 2-sided frame is built from sturdy, durable aluminum frame. With an easy-to-use snap frame and edge-lit LED bulbs, Lainster lightbox stand is useful for darker venues, such as halls and movie theaters. The vertical holder tubes, ensuring that the double sided poster display can be seen from any angle. Designed for day or night time use, the illuminated lightbox stand has clear PVC lens to prevent glare, while the LED bulbs highlight signage.



## NOGALES

\* W: Width H: Height D: Depth \*mm

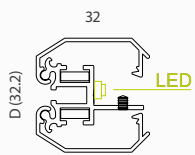
Ref.	Graphic Size	Visual (X-Y)	External (WxHxD)	Tube H	Profile	Packing (QTY)	N.W	G.W	C.B.M	Size (WxHxD)
13.190	A0	815x1163	880x1228x32.2	1228		1	10.8kg	13.4kg	0.1050	964x1379x79
13.191	A1	568x815	633x880x32.2	880		1	6.05kg	7.85kg	0.0584	717x1031x79
13.192	A2	394x568	459x633x32.2	633		1	3.5kg	4.6kg	0.0336	543x784x79
13.193	A3	271x394	336x459x32.2	459		1	2.15kg	2.85kg	0.0140	420x610x79
13.194	A4	184x271	249x336x32.2	336		1	1.35kg	1.9kg	0.0128	333x487x79
13.289	500x700	474x673	539x738x32.2	738		1	4.55kg	5.85kg	0.0438	623x890x79
13.290	700x1000	674x974	739x1039x32.2	1039		1	7.95kg	9.95kg	0.0727	790x1165x79

\* Other sizes available upon request / Autres dimension sur demande / Outros tamanhos disponíveis sob consulta / Otros tamaños disponibles bajo pedido.

STAND DETAILS



INFORMATION

DIMENSIONS

This multifunction tablet stand provides a Tablet Holder with foam pads for a better grip and a 500x700mm aluminium click frame. Two colors available white or black finish. This holder has an 1700mm aluminium pole with heavy silver steel base. Metal enclosure anti-theft system by 2 keys. Easily rotate 360° the enclosure for displaying portrait or landscape presentation. The tablet cable pass through the pole for a clean look. Request us for 2-sided frame or other Click frame sizes.



TABLET STAND		* W: Width	H: Height	D: Depth	*mm
	External (WxHxD)	Frame (XxY)			
Product	540x1922xØ420	500x700			
13.876		For tablet screen: 9.7" or 10.5"			

CLICK FRAME  
TABLET STAND



STAND DETAILS

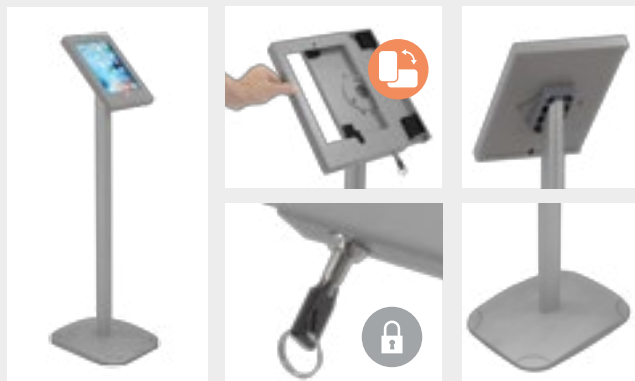

INFORMATION

DIMENSIONS

This Tablet Stand is available in grey color has a metal enclosure anti-theft system and the enclosure rotates easily for portrait or landscape view. Tablet Holder has foam pads for a better grip and to prevent scratches. The tablet cable passes through the pole for a clean look. Cable not included. Ideal for trade shows, academies, exhibitions or for events.



TABLET STAND		* W: Width	H: Height	D: Depth	*mm
	External (WxHxD)				
Product	± 250x1000x330				
13.877		For tablet screen: 9.7" or 10.5"			

SLIDING LOCK  
TABLET STAND



\* the tablets at this page are not included.

STAND DETAILS



ACCESSORIES INCLUDED



INFORMATION

DIMENSIONS

This modern slim Tablet Stand is constructed on heavy duty metal. White and black color available. It features a metal enclosure anti-theft system. Tablet Holder has foam pads for a better grip and to prevent scratches. The enclosure rotates easily for portrait or landscape presentation. The tablet cable passes through the stand for a clean look. This tablet stand includes the accessories 1 Top banner plate, 2 Top magnetic graphic and 3 Power bank box.



TABLET STAND

\* W: Width H: Height D: Depth \*mm

	QTY	N.W	G.W	C.B.M	Size (WxHxD)
Packing	1	15kg	16kg	0.0859	310x1260x220
	External (WxHxD)				
Product	340x1280x390				
13.858-1		For 9.7" tablet screen			
13.858-2		For 9.7" tablet screen			

FLOOR METAL TABLET STAND

**NEW**

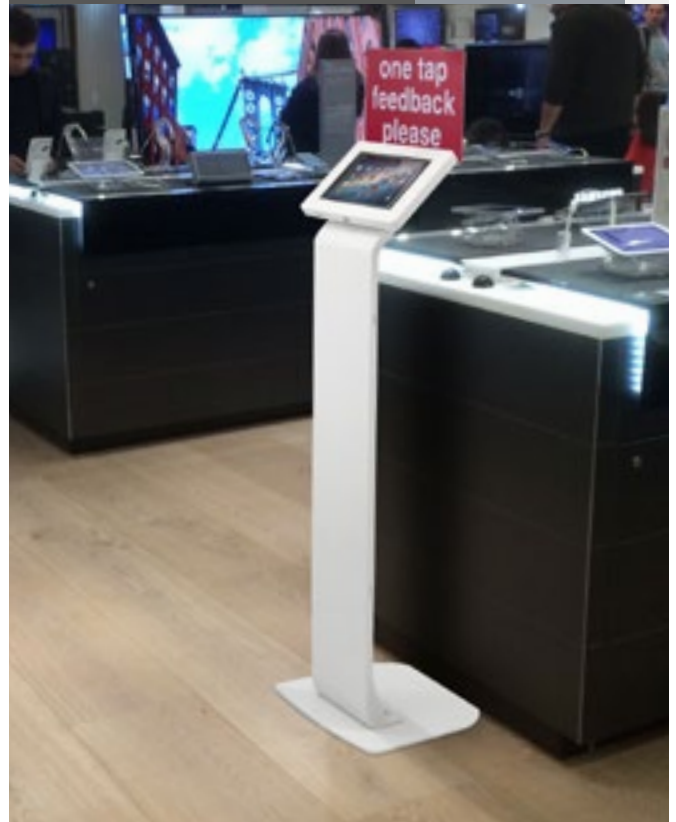

\* the tablets at this page are not included.



## STAND DETAILS



## INFORMATION

## DIMENSIONS

This modern Console Station is constructed on heavy duty metal. With a metal enclosure anti-theft system. The tablet cable passes through the stand for a clean look. Tablet Holder has foam pads for a better grip and to prevent scratches. Black and white finish available. Request us for optional interchangeable magnetic graphic banner.

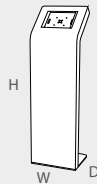

## TABLET STAND

\* W: Width H: Height D: Depth \*mm

	QTY	N.W	G.W	C.B.M	Size (WxHxD)
Packing	1	23kg	26.50kg	0.219	1340x430x380
	External (WxHxD)				
Product	360x1260x300				
13.857-1		For tablet screen: 9.7" or 10.5"			
13.857-2		For tablet screen: 9.7" or 10.5"			

## CONSOLE STATION TABLET STAND



## STAND DETAILS

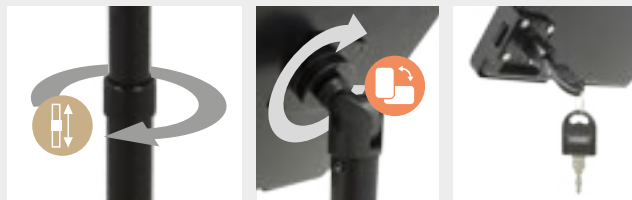

## INFORMATION

## DIMENSIONS

This black finished Tablet stand is designed for both sitting and standing thanks its telescopic pole. Also, an anti-theft system keeps the technology safely locked. Users may easily rotate 360° or tilt the bracket of the adjustable tablet floor stand for different viewing angles. Tablet Holder has foam pads for a better grip and to prevent scratches. The holder's touchscreen unique design allows access to the home and power buttons while also leaving the auxiliary port open, perfect for credit card readers.

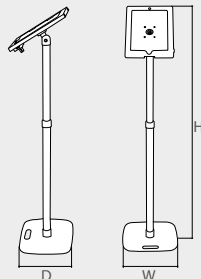

## TABLET STAND

\* W: Width H: Height D: Depth \*mm

	QTY	N.W	G.W	C.B.M	Size (WxHxD)
Packing	1	4kg	4.25kg	0.037	395x760x125
	External (WxHxD)				
Product	245x1350x280				
10.306		For Tablet: ± 242.8x189.7mm			

## ADJUSTABLE POLE TABLET STAND

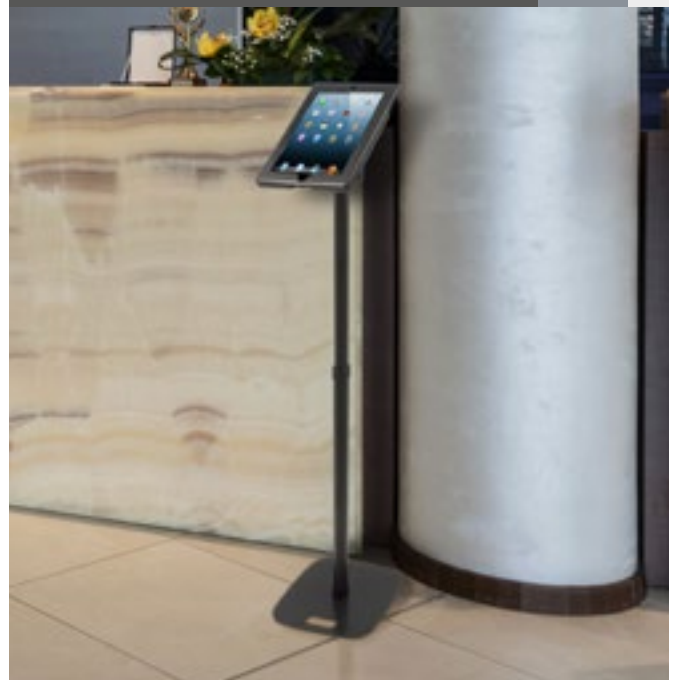

\* the tablets at this page are not included.

**new**

STAND DETAILS

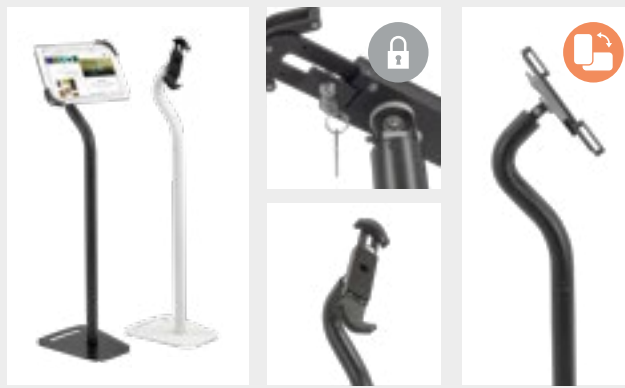

SWAN CLAMP  
TABLET STAND

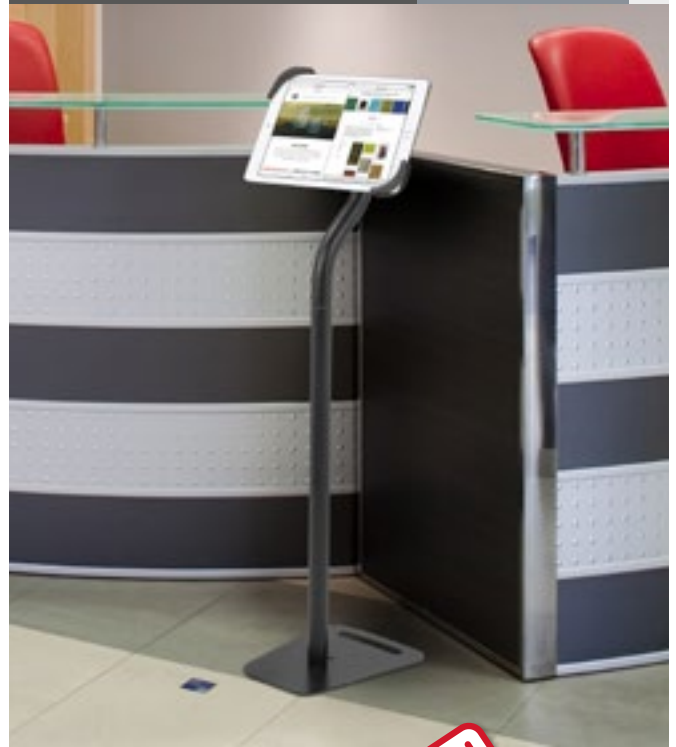

INFORMATION

DIMENSIONS

This swan neck Tablet Stand is available in white or black finish. This holder has an universal enclosure anti-theft system. With Kensington hole for additional security. Easily rotates 360° and tilts the enclosure for displaying in different view angles. The tablet cable passes through the pole for getting a clean look.



TABLET STAND		* W: Width	H: Height	D: Depth	*mm
Packing	QTY	N.W	G.W	C.B.M	Size (WxHxD)
	1	25kg	28kg	0.4838	890x420x110
		External (WxHxD)			
Product	300x190x380				
13.856-1		For Tablets from 7.9" to 10.5"			
13.856-2		For Tablets from 7.9" to 10.5"			

**new**

STAND DETAILS



FLOOR & DESKTOP  
TABLET STAND



INFORMATION

DIMENSIONS

This 2-in-1 tablet support is designed for floor or desk use. White or black color. Tablet Holder has foam pads for a better grip and to prevent scratches. With metal enclosure anti-theft system and Kensington hole. Holder easily rotates for portrait or landscape display. The tablet cable passes through the pole for a clean look.



TABLET STAND   DESK		* W: Width	H: Height	D: Depth	*mm
Packing	QTY	N.W	G.W	C.B.M	Size (WxHxD)
	1	28kg	32kg	0.4838	890x420x110
		External (WxHxD)			
Product	300x190x380				
13.855-1		For 9.7" or 10.5" tablets			
13.855-2		For 9.7" or 10.5" tablets			

\* the tablets at this page are not included.

**NEW**

**STAND DETAILS**

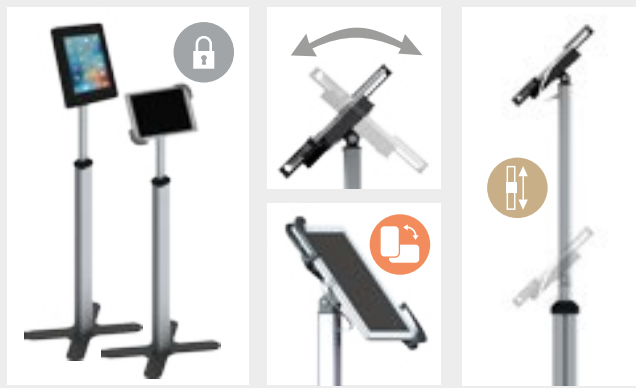

**INFORMATION**

**DIMENSIONS**

This tablet floor stand is designed for both sitting and standing use thanks its telescopic pole. In addition, this stand has two available holding systems, universal clamp or metal enclosure. Holder easily rotates 360° and tilts for displaying in different view angles. The tablet cable passes through the pole for a clean look.



TABLET STAND		* W: Width	H: Height	D: Depth	*mm
Packing	QTY: 1 N.W: 1kg G.W: 1.55kg C.B.M: 0.006 Size (WxHxD): 365x92x204				
Product	800-1300				
13.868	Universal clamp for tablets from ± 7.9" to 10.5"				
13.869	Metal enclosure for tablet screen ± 9.7" or 10.5"				

**DOUBLE ENCLOSURE TELESCOPIC TABLET STAND**



**FRAME DISPLAY DETAILS**



**INFORMATION**

\* mm

This Tablet Holder is designed for desk or wall mounting. Also, an anti-theft system keeps the technology safely locked. It has foam pads for a better grip and to prevent the scratches. The touchscreen holder's unique design allows access to the home and power buttons while also leaving the auxiliary port open, perfect for credit card readers. The bracket rotates easily 90° for different viewing angles.

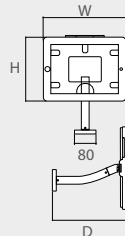

TABLET WALL   DESK		* W: Width	H: Height	D: Depth	*mm
Packing	QTY: 1 N.W: 1kg G.W: 1.55kg C.B.M: 0.006 Size (WxHxD): 365x92x204				
Product	248x194x270				
14.108	For Tablet: ± 240x185mm				

**METAL FRAME WALL DESK TABLET HOLDER**



\* the tablets at this page are not included.

**new**

**STAND DETAILS**



**INFORMATION**

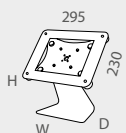

**DIMENSIONS** \* mm

Desktop support with Z shape aluminium base and Kensington hole for additional security. Acrylic enclosure locks by 4 screws and rotates for portrait or landscape display. Tablet Holder has foam pads for a better grip and to prevent scratches. Compatible install of Square-Paypal card readers. Black and white colour.



**TABLET DESK**

\* W: Width H: Height D: Depth \*mm

	QTY	N.W	G.W	C.B.M	Size (WxHxD)
Packing	1	1.75kg	1.92kg	0.0201	340x200x295
		External (WxHxD)			
Product		210x300x150			
13.851-1		For 9.7" or 10.5" tablets			
13.851-2		For 9.7" or 10.5" tablets			

**ACRYLIC FRAME  
DESK TABLET HOLDER**



**new**

**STAND DETAILS**



**INFORMATION**

**DIMENSIONS** \* mm

Desktop Tablet support with Z shape aluminium base and kensington hole for additional security. Metal enclosure locking with key and rotates for portrait or landscape display. Tablet Holder has foam pads for a better grip and to prevent scratches. Available in black and white.

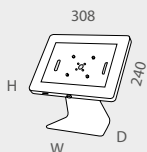

**TABLET DESK**

\* W: Width H: Height D: Depth \*mm

	QTY	N.W	G.W	C.B.M	Size (WxHxD)
Packing	1	1.75kg	1.92kg	0.0201	340x200x295
		External (WxHxD)			
Product		210x315x150			
13.852-1		For 9.7" or 10.5" tablets			
13.852-2		For 9.7" or 10.5" tablets			

**METAL CASE  
DESK TABLET HOLDER**



\* the tablets at this page are not included.



**new**

STAND DETAILS



INFORMATION

DIMENSIONS \* mm

Desktop or wall mounting tablet support with full range of movement thanks to its durable metal flexing column. Acrylic enclosure locks by 4 screws and rotates for portrait or landscape display. Compatible install of Square-Paypal card readers. Available in black and white.

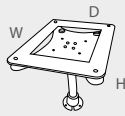

TABLET STAND		* W: Width	H: Height	D: Depth	*mm
	QTY	N.W	G.W	C.B.M	Size (WxHxD)
Packing	1	1.33kg	1.83kg	0.0113	350x280x115
	External (WxHxD)				
Product	295x250x230				
13.853-1		For 9.7" or 10.5" tablets			
13.853-2		For 9.7" or 10.5" tablets			

FLEX ACRYLIC  
WALL DESK TABLET HOLDER



STAND DETAILS



INFORMATION

DIMENSIONS \* mm

Desktop or wall mounting tablet support with full range of movement thanks to its durable metal flexing column. Metal enclosure locks with key and kensington hole for additional security. Tablet Holder has foam pads for a better grip and to prevent scratches. Available in black and white.

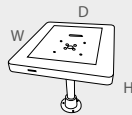

TABLET STAND		* W: Width	H: Height	D: Depth	*mm
	QTY	N.W	G.W	C.B.M	Size (WxHxD)
Packing	1	1.33kg	1.83kg	0.0113	350x280x115
	External (WxHxD)				
Product	310x250x240				
13.854-1		For 9.7" or 10.5" tablets			
13.854-2		For 9.7" or 10.5" tablets			

FLEX METAL  
WALL DESK TABLET HOLDER



\* the tablets at this page are not included.

## STAND DETAILS



## INFORMATION

\*mm

The Sligo Lectern features a double A4-Size reading metallic surface with ring binder. Sligo is ideal for displaying menus at the restaurant entrances, catalogues at retail stores or for presentations at the auditoriums.

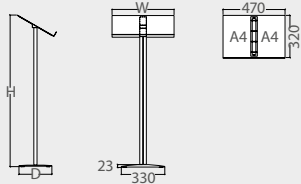

## SLIGO METALLIC

\* W: Width H: Height D: Depth \*mm

	QTY	N.W	G.W	C.B.M	Size (WxHxD)	
Packing	1	4.3kg	4.7kg	0.0107	330x500x65	 x2
	1	1.15kg	1.3kg	0.0028	40x1070x65	
	External (WxHxD)					
Product	470x147x250					
10.984	Literature Holder: A4 (x2)					

## SLIGO METALLIC BINDER

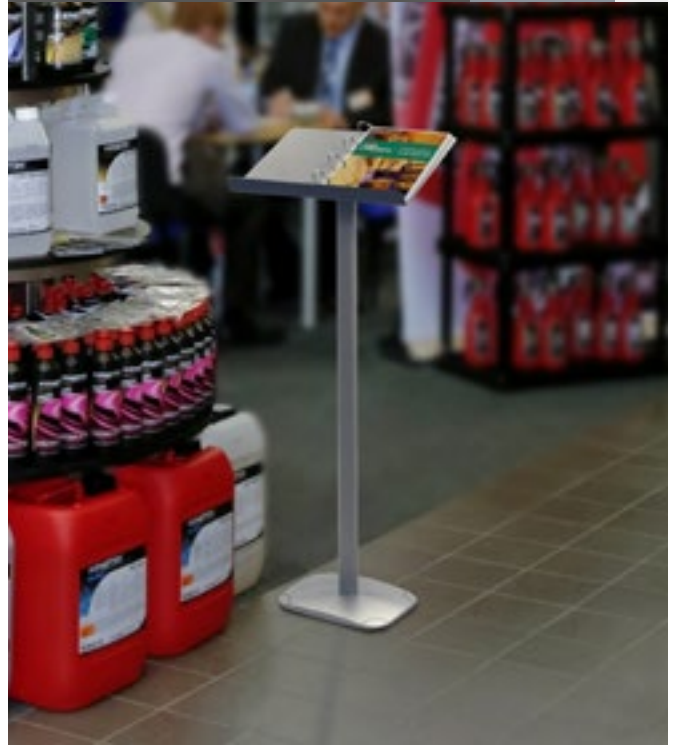

## STAND DETAILS



## INFORMATION

\*mm

The Sligo Lectern features a double A4-Size reading acrylic surface with ring binder. Sligo is ideal for displaying menus at the restaurant entrances, catalogues at retail stores or for presentations at the auditoriums.

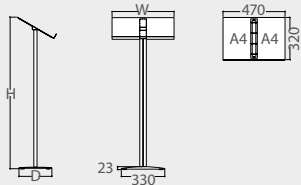

## SLIGO ACRYLIC

\* W: Width H: Height D: Depth \*mm

	QTY	N.W	G.W	C.B.M	Size (WxHxD)	
Packing	1	2.75kg	3kg	0.0107	330x500x65	 x2
	1	1.15kg	1.3kg	0.0028	40x1070x65	
	External (WxHxD)					
Product	470x147x250					
10.983	Literature Holder: A4 (x2)					

## SLIGO ACRYLIC BINDER



## STAND DETAILS



## DIMENSIONS

REF 13.123

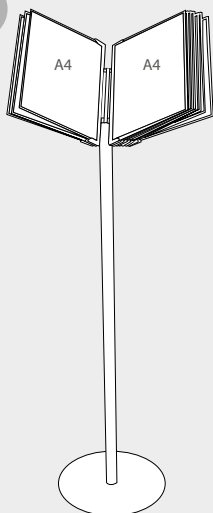

REF 13.122

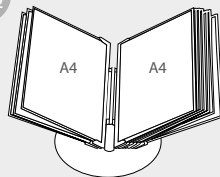

## INFORMATION

This Binder Stands are made of steel, rubber and plastic and includes 10 A4 format plastic sleeves. There are 2 models available: desktop option or with solid and stand base. Ideal for restaurants, coffee stores as menu holder or for trade shows and retail stores for being used as a catalogue display-book.

MENUBOOK 1	QTY	N.W	G.W	C.B.M	SIZE
Packing	1	1.9kg	2.15kg	0.012	340x100x360 mm
13.122	Graphic Size: A4 "Black"			x1 	
MENUBOOK 2	QTY	N.W	G.W	C.B.M	SIZE
Packing	1	5.2kg	5.4kg	0.018	345x155x345 mm
13.123	Graphic Size: A4 "Black"			x1 	

## PLASTIC POCKETS BINDER STAND

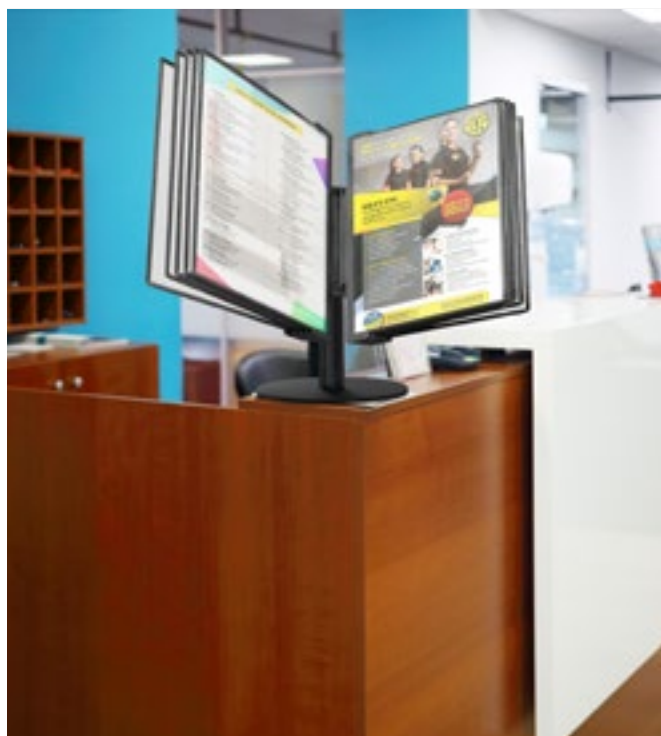
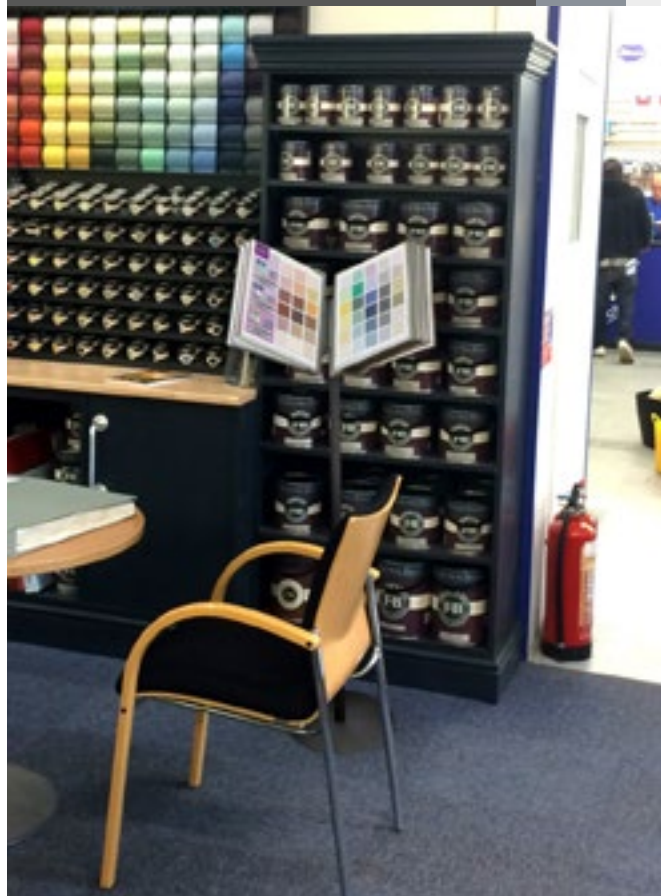

HOLDER DETAILS



INFORMATION

\* mm

This Display for catalogs is made of 3mm thickness acrylic and features a 4 rings binder. This transparent acrylic Stand can display 2 portrait A4 format documents, so it is an excellent addition to any retail store or personal collection for the exhibition of promotional catalogues.

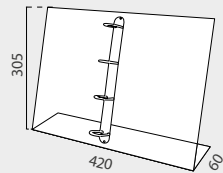

C.DISPLAY	SIZE	THICKNESS	
13.043	A4 + A4	3mm	x2 

ACRYLIC CATALOGUE HOLDER



STAND DETAILS



INFORMATION

\* mm

This Display for catalogs is made of 3mm thickness acrylic and features a 4 rings binder. This transparent Stand can display landscape A4 format documents and it is double-sided, so it is an excellent addition to any retail store or personal collection for the exhibition of promotions.

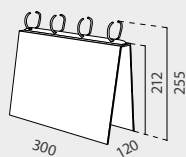

S.DISPLAY	SIZE	THICKNESS	
13.404	A4 + A4	3mm	x2 

ACRYLIC RING BINDER



STAND DETAILS



INFORMATION

\* W: Width H: Height D: Depth \* mm

This stylish stand is made of aluminum and acrylic with a metal base that provides greater stability. Features an A5 sandwich graphic holder for an easy graphic change. Also it has a useful 1/3 A4 leaflet dispenser.

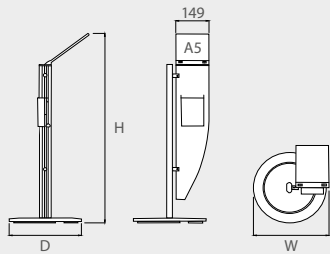

NEILA	SIZE (WxHxD)	GRAPHIC SIZE	LEAFLET
13.675	343x885x330mm	A5	1/3 A4 x1 

NEILA



STAND DETAILS



DIMENSIONS

\* mm

This stand is made of 8mm thickness acrylic and features a graphic holder (300x420mm) for displaying relevant information of products. This acrylic stand is great for displaying offers inserting the stand between the mattresses and the base. Ability to fix an A3 Adhesive PVC Pocket ref. 13.064 (sold separately) to exchange the graphics quicker.

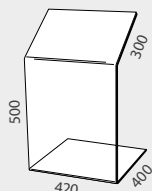

ACRYLIC STAND	SIZE	THICKNESS
50.339	400x420x715mm	8mm x2 

ACRYLIC  
INFO FLOOR STAND



ALUMINIUM  
LECTERN





STAND DETAILS

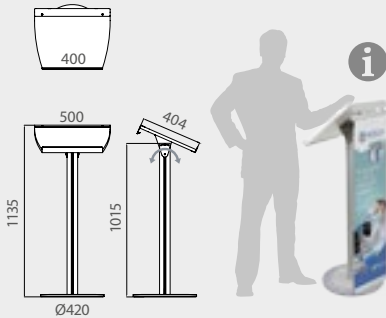

DIMENSIONS AND OPTIONAL ACCESSORY 

\*mm



 The back of the surface of this Lectern provides the possibility of attaching an Alulon Poster System (Ref: 10571) to place a banner and customize the look of the lectern. For more information, see Signage chapter.

INFORMATION

This aluminium lectern includes a 19mm thickness white wooden reading surface with a matching aluminum post and circular base offering modern visual displays. The reading surface on this lectern includes a book stop to support your notes during a presentation for award recipients, sheet music for a performance, or a seating chart to assist a hostess, also it features an adjustable angle view for the reading surface. With its sleek contemporary design, this podium is easy to assemble, requiring only a screwdriver and a few minutes. Its silver aluminum pole and base are durable and will last through years of performances and presentations. This stylish yet affordable lectern is a great addition to any presentation space, such as auditoriums, restaurants for menu displays or convention centers to attract the attention of your audience.



Ref: 10571

Alulon Poster System see in Signage chapter (Optional accessory)

ALUMINIUM LECTERN \* W: Width H: Height D: Depth \*mm

	QTY	N.W	G.W	C.B.M	Size (WxHxD)	
Packing	1	8.2kg	8.5kg	0.0097	440x440x50	 x3
	1	1.59kg	1.75kg	0.0067	80x80x1040	
	1	3.95kg	4.7kg	0.0413	530x445x175	
	External (WxHxD)					
Product	± 500x1135x420					
13.640						

STAND DETAILS



DIMENSIONS AND OPTIONAL ACCESSORY  \*mm

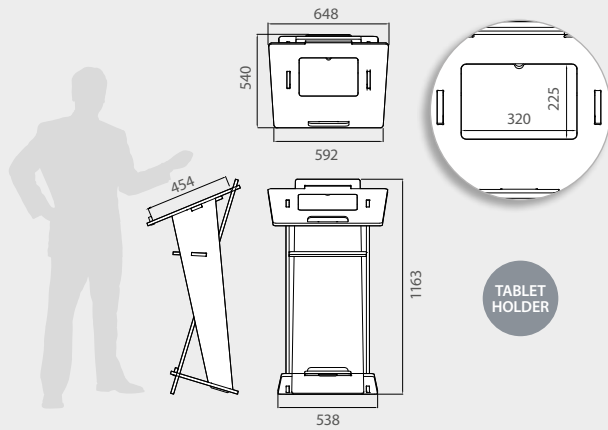

INFORMATION

This stunning wooden lectern does not require the use of any tools for its assembly thanks to its Patent System. Each of its 10 pieces is designed to complete a sturdy and firm structure in very few steps. It is made of 16mm thickness Waterproof MDF Wood with a natural stylish grey finish. It features one shelf in the interior of the lectern, so this way, the extra brochures, business cards and documents can be stored out of sight so your exhibition always appears clean and organized. Also, it features a 318x207mm holder at the top surface for placing securely a tablet. The Fast Wooden Lectern is ideal for being used at auditoriums or convention centers to attract the attention of your audience.

WOODEN LECTERN \*mm

	QTY	N.W	G.W	C.B.M	Size (WxHxD)
Packing	1	19kg	21.41kg	0.0832	605x105x1310
13.641					

REMOVABLE  
WOODEN LECTERN



LECTERN SET-UP 10 MANUALLY ATTACHABLE PARTS



\* the tablets at this page are not included.

## STAND DETAILS



## DIMENSIONS

\* W: Width H: Height D: Depth \* mm

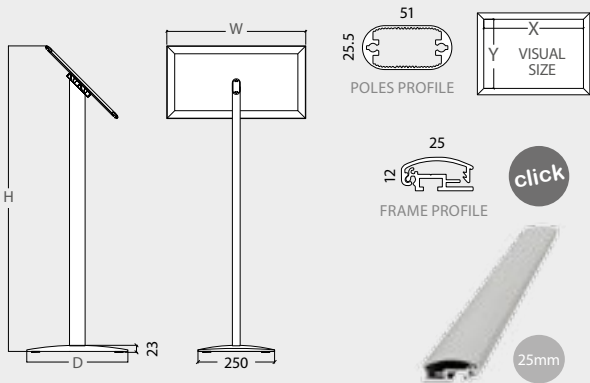

## INFORMATION

This Menu Stand features a sturdy aluminium structure with plastic parts. Its Click System frame allows an easy and quick graphic change (anti-reflex cover included). Frames features portrait or a landscape configuration. It is ideal for retail stores, hotel lobbies, restaurant entrances, car dealerships and real states.

### ZAFRA A3 \*mm

	QTY	N.W	G.W	C.B.M	Size (WxHxD)	
Packing	1	0.75kg	0.95kg	0.0047	60x930x85	
	1	1.65kg	1.76kg	0.0034	275x355x35	
	1	0.65kg	0.85kg	0.0061	365x480x35	
	Visual (X-Y)		External (WxHxD)			
Product	400x277		453x998x330			
10.159	Graphic Size: A3					

### ZAFRA A4 \*mm

	QTY	N.W	G.W	C.B.M	Size (WxHxD)	
Packing	1	0.75kg	0.95kg	0.0047	60x930x85	
	1	1.65kg	1.76kg	0.0034	275x355x35	
	1	0.45kg	0.55kg	0.0024	270x350x25	
	Visual (X-Y)		External (WxHxD)			
Product	190x278		311x960x330			
10.158	Graphic Size: A4					

## ZAFRA





STAND DETAILS

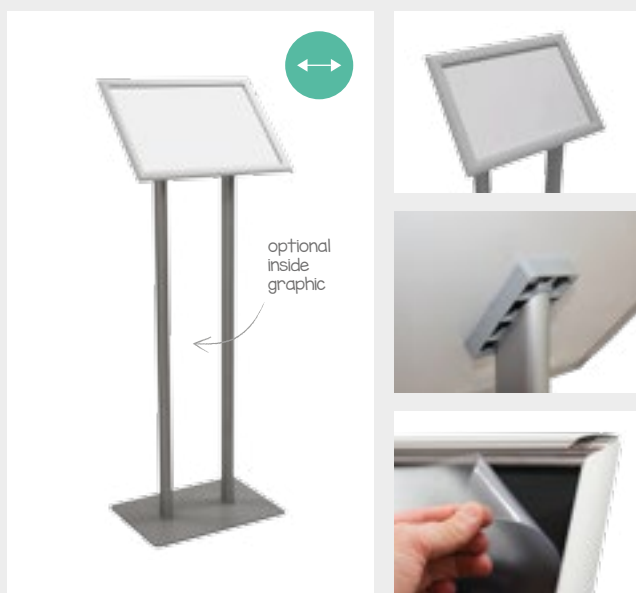

DIMENSIONS

\* W: Width H: Height D: Depth \* mm

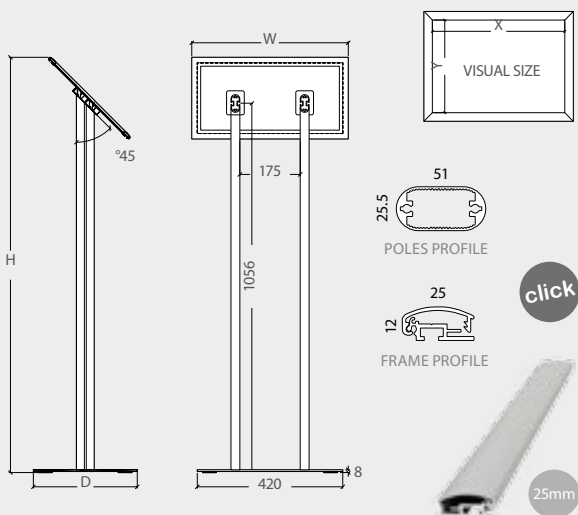

INFORMATION

This Ulster Menu Stand is made of aluminium and features an anti-reflex protection cover for its A3 frame. The Ulster frame borders snap open which allows you to insert quickly and easily your printed graphics. Also, it features the option of customize with an inside graphic. It is ideal for hotel lobbies, for restaurant entrances, car dealerships or real states.

**ULSTER** W: Width H: Height D: Depth \*mm

	QTY	N.W	G.W	C.B.M	Size (WxHxD)
Packing	1	2.15kg	2.5kg	0.0102	145x1170x60
	1	5kg	5.3kg	0.0061	365x480x35
	1	0.65kg	0.85kg	0.0061	365x480x35
	Visual (X-Y)		External (WxHxD)		
Product	400x277		452x1200x300		
10.982	Graphic Size: A3				

ULSTER



STAND DETAILS

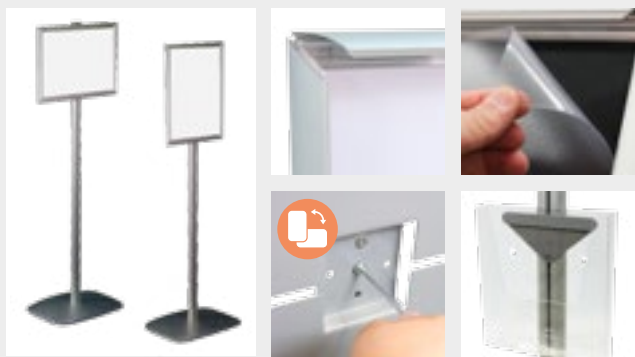

DIMENSIONS

\* W: Width H: Height D: Depth \* mm

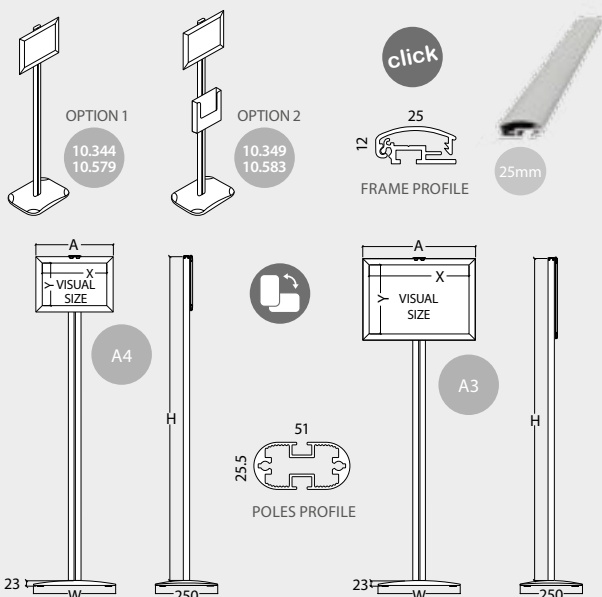

INFORMATION

Melgar 1-sided features a sturdy aluminium structure with plastic parts. Its Click System frame allows an easy and quick graphic change (anti-reflex cover included). Frames allows an easy portrait or a landscape change configuration. Also Melgar is available with an A4 leaflet dispenser. It is ideal for retail stores, hotel lobbies, restaurant entrances, car dealerships and real states.

MELGAR ONE-SIDED





MELGAR A4 1SIDED

W: Width H: Height D: Depth \* mm

	QTY	N.W	G.W	C.B.M	Size (WxHxD)	
Packing	1	1.15kg	1.25kg	0.0035	65x1340x40	 x3 
	1	2.8kg	2.93kg	0.0036	263x388x35	
	1	0.82kg	0.91kg	0.0024	350x270x25	
	Visual (X-Y)		External (WxHxA)			
Product	190x278		330x1326x311			
10.344	Graphic Size: A4					



MELGAR A3 1SIDED

W: Width H: Height D: Depth \* mm

	QTY	N.W	G.W	C.B.M	Size (WxHxD)	
Packing	1	1.15kg	1.25kg	0.0035	65x1340x40	 x3 
	1	2.8kg	2.93kg	0.0032	263x388x35	
	1	1.44kg	1.74kg	0.0042	475x355x25	
	Visual (X-Y)		External (WxHxA)			
Product	278x401		330x1326x453			
10.579	Graphic Size: A3					



MELGAR A4 1S+DISPENSER

W: Width H: Height D: Depth \* mm

	QTY	N.W	G.W	C.B.M	Size (WxHxD)	
Packing	1	1.15kg	1.25kg	0.0035	65x1340x40	 x4 
	1	2.8kg	2.93kg	0.0036	263x388x35	
	1	0.4kg	0.55kg	0.0029	235x250x50	
	1	0.82kg	0.91kg	0.0024	350x270x25	
	Visual (X-Y)		External (WxHxA)			
Product	190x278		330x1326x311			
10.349	Graphic Size: A4		with A4  x1			

MELGAR A3 1S+DISPENSER

W: Width H: Height D: Depth \* mm

	QTY	N.W	G.W	C.B.M	Size (WxHxD)	
Packing	1	1.15kg	1.25kg	0.0035	65x1340x40	 x4 
	1	2.8kg	2.93kg	0.0036	263x388x35	
	1	0.4kg	0.55kg	0.0029	235x250x50	
	1	1.44kg	1.74kg	0.0042	475x355x25	
	Visual (X-Y)		External (WxHxA)			
Product	278x401		330x1326x453			
10.583	Graphic Size: A3		with A4  x1			

STAND DETAILS

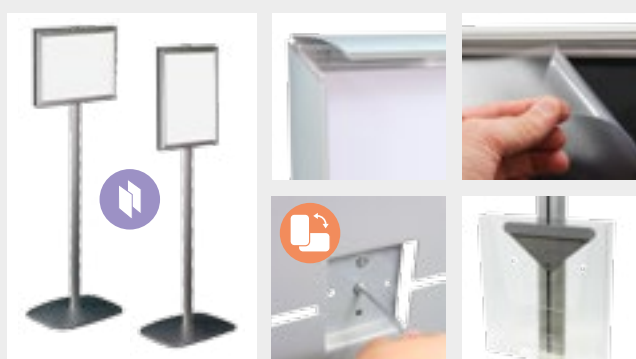

DIMENSIONS

\* W: Width H: Height D: Depth \* mm

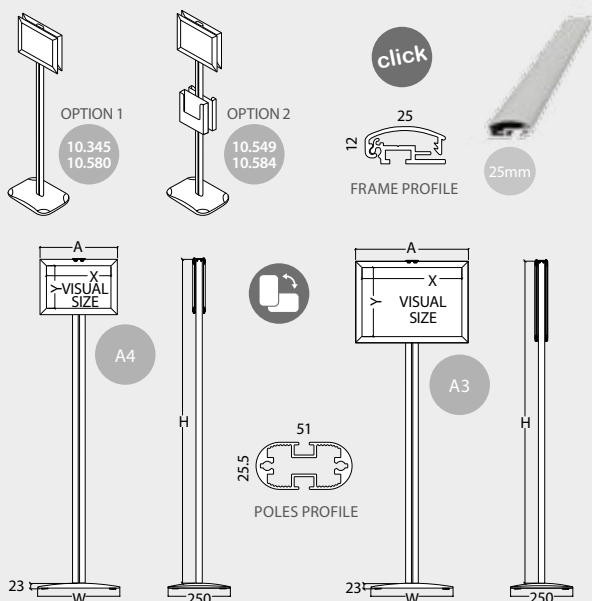

INFORMATION



Melgar 2-sided features a sturdy aluminium structure with plastic parts. Its Click System frame allows an easy and quick graphic change (anti-reflex cover included). Frames allows an easy portrait or a landscape change configuration. Also Melgar is available with an A4 leaflet dispenser. It is ideal for retail stores, hotel lobbies, restaurant entrances, car dealerships and real states.

MELGAR TWO-SIDED





MELGAR A4 2SIDED

W: Width H: Height D: Depth \* mm

	QTY	N.W	G.W	C.B.M	Size (WxHxD)	
Packing	1	1.15kg	1.25kg	0.0035	65x1340x40	 x4 
	1	2.8kg	2.93kg	0.0036	263x388x35	
	2	0.82kg	0.91kg	0.0024	350x270x25	
Product	Visual (X-Y) 190x278		External (WxHxA) 330x1326x329			
10.345	Graphic Size: A4					



MELGAR A3 2SIDED

W: Width H: Height D: Depth \* mm

	QTY	N.W	G.W	C.B.M	Size (WxHxD)	
Packing	1	1.15kg	1.25kg	0.0035	65x1340x40	 x4 
	1	2.8kg	2.93kg	0.0036	263x388x35	
	2	1.44kg	1.74kg	0.0042	475x355x25	
Product	Visual (X-Y) 278x401		External (WxHxA) 330x1326x453			
10.580	Graphic Size: A3					



MELGAR A4 2S+2 DISPENSERS

W: Width H: Height D: Depth \* mm

	QTY	N.W	G.W	C.B.M	Size (WxHxD)	
Packing	1	1.15kg	1.25kg	0.0035	65x1340x40	 x6 
	1	2.8kg	2.93kg	0.0036	263x388x35	
	2	0.4kg	0.55kg	0.0029	235x250x50	
	2	0.82kg	0.91kg	0.0024	350x270x25	
Product	Visual (X-Y) 190x278		External (WxHxA) 330x1326x311			
10.549	Graphic Size: A4			with A4  x2		

MELGAR A3 2S+2 DISPENSERS

W: Width H: Height D: Depth \* mm

	QTY	N.W	G.W	C.B.M	Size (WxHxD)	
Packing	1	1.15kg	1.25kg	0.0035	65x1340x40	 x6 
	1	2.8kg	2.93kg	0.0036	263x388x35	
	2	0.4kg	0.55kg	0.0029	235x250x50	
	2	1.44kg	1.74kg	0.0042	475x355x25	
Product	Visual (X-Y) 278x401		External (WxHxA) 330x1326x453			
10.584	Graphic Size: A3			with A4  x2		

STAND DETAILS



DIMENSIONS

\* W: Width H: Height D: Depth \* mm

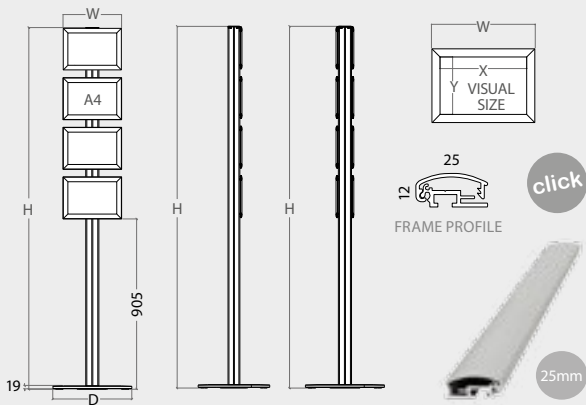

INFORMATION

Info Stands can be used in a variety of locations to showcase eye-catching signage. These stands are made of aluminum with a smooth silver finish and they are equipped with A4 click frames. It features a 8kg weight steel base. If you choose single-sided model you can display 4x A4-sized graphics or 8x A4-sized graphics for double-sided model.

GUADALUPE A4 SINGLE

W: Width H: Height D: Depth \* mm

	QTY	N.W	G.W	C.B.M	Size (WxHxD)	
Packing	1	2.8kg	3.6kg	0.0123	80x1920x80	 x6 
	1	8.2kg	8.5kg	0.0097	440x440x50	
	4	0.45kg	0.55kg	0.0024	270x350x25	
	Visual (X-Y)		External (WxHxD)			
Product	190x278	311x1922x Ø420				
10.154	Graphic Size: A4 x 4uni.					

GUADALUPE A4 DOUBLE

W: Width H: Height D: Depth \* mm

	QTY	N.W	G.W	C.B.M	Size (WxHxD)	
Packing	1	2.8kg	3.6kg	0.0123	80x1920x80	 x10 
	1	8.2kg	8.5kg	0.0097	440x440x50	
	8	0.45kg	0.55kg	0.0024	270x350x25	
	Visual (X-Y)		External (WxHxD)			
Product	190x278	311x1922x Ø420				
10.156	Graphic Size: A4 x 8uni.					

GUADALUPE A4

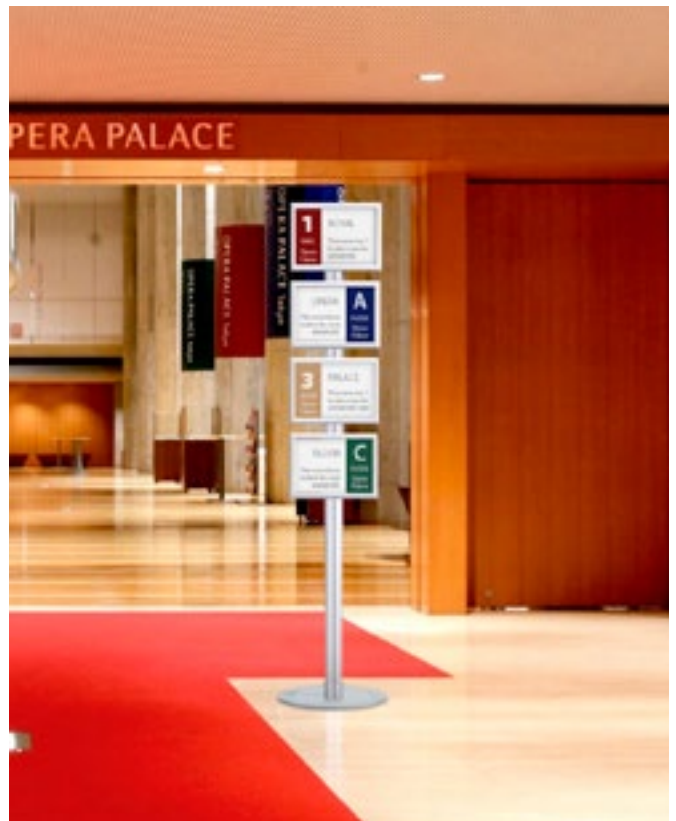

STAND DETAILS



DIMENSIONS

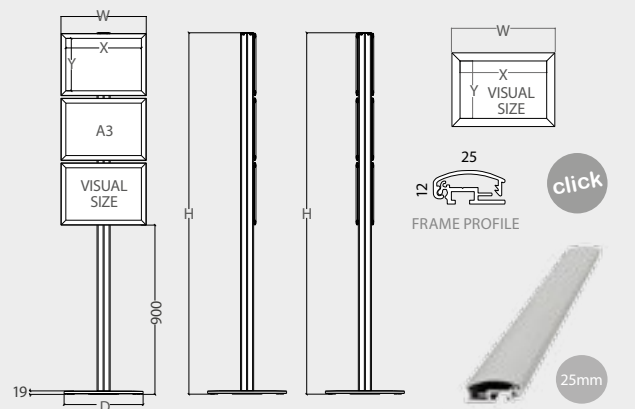

\* W: Width H: Height D: Depth \* mm



INFORMATION



Sign displays can be used in a variety of indoor locations to showcase eye-catching graphics and signage. These sign displays are equipped with click frames which let you display A3 graphics. If you choose the configuration of single-sided, you can display 3x A3-sized graphics. Also you can create a double-sided presentation by attaching your sign holders back to back and exposing 6x A3-sized graphics. Guadalupe T. These sign displays are made of aluminum and feature a smooth silver finish.

GUADALUPE A3 SINGLE \* W: Width H: Height D: Depth \* mm

	QTY	N.W	G.W	C.B.M	Size (WxHxD)	
Packing	1	2.8kg	3.6kg	0.0123	80x1920x80	 x5 
	1	8.2kg	8.5kg	0.0097	440x440x50	
	3	0.65kg	0.85kg	0.0061	365x480x35	
	Visual (X-Y)		External (WxHxD)			
Product	278x401		453x1922x Ø420			

10.155 Graphic Size: A3 x 3uni.

GUADALUPE A3 DOUBLE \* W: Width H: Height D: Depth \* mm

	QTY	N.W	G.W	C.B.M	Size (WxHxD)	
Packing	1	2.8kg	3.6kg	0.0123	80x1920x80	 x8 
	1	8.2kg	8.5kg	0.0097	440x440x50	
	6	0.65kg	0.85kg	0.0061	365x480x35	
	Visual (X-Y)		External (WxHxD)			
Product	278x401		453x1922x Ø420			

10.157 Graphic Size: A3 x 6uni.

GUADALUPE A3



click



## STAND DETAILS

**SIZES** \* W: Width H: Height D: Depth \* mm

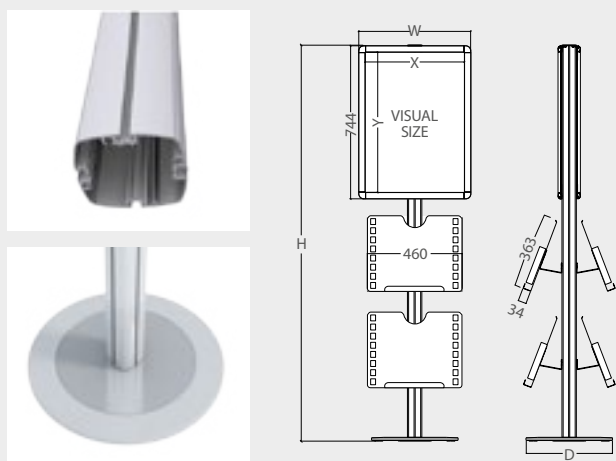

## INFORMATION

The Combi Stand consists of an aluminium pole profile, a solid 8kg steel base and multiple possible configurations to choose from, featuring the number of literature holders trays (1-8 units available), the possibility of incorporating one or more upper Click system frames (there are different sizes and also, 2-sided design available). All Combi Stand models are supplied in complete Kits. The Combi Stands are ideal for being used in trade shows, lobby areas, for museums, hotel lobbies, shopping malls, gymnasiums or for the airports.

## COMBI STAND

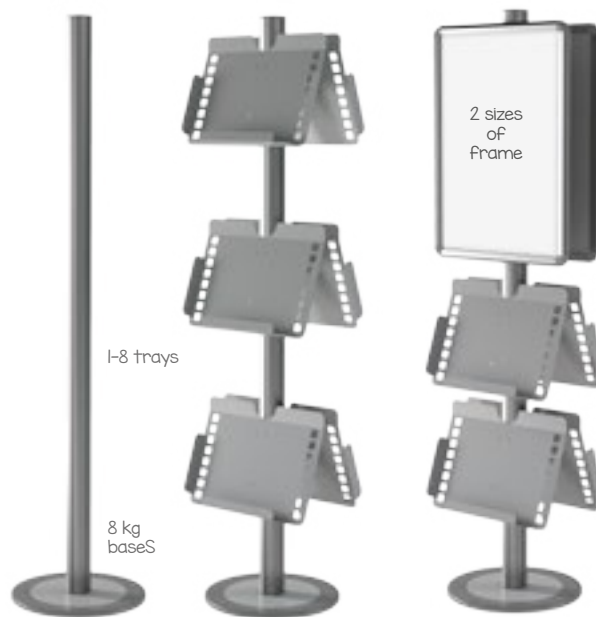

## COMBI ONE

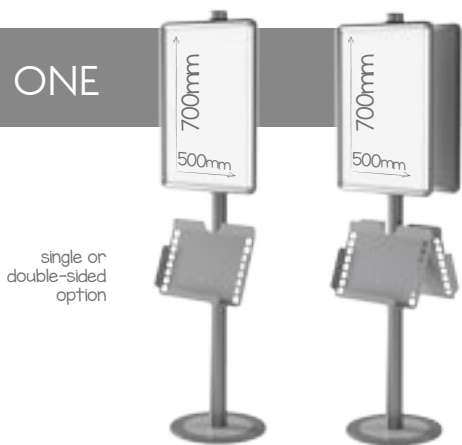

single or double-sided option

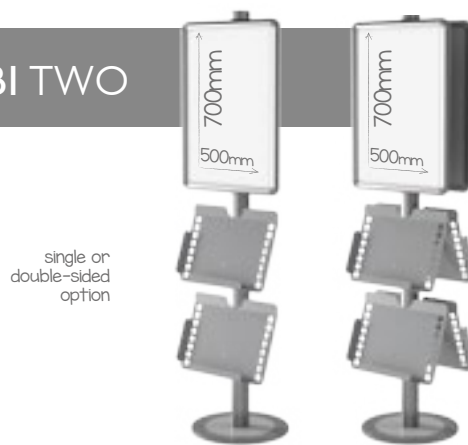

## COMBI TWO



single or double-sided option

### COMBI ONE 1SIDED

\* W: Width H: Height D: Depth \*mm



	QTY	N.W	G.W	C.B.M	Size (WxHxD)	
Packing	1	2.8kg	3.6kg	0.0123	80x1920x80	 x4 
	1	8.2kg	8.5kg	0.0097	440x440x50	
	1	1.95kg	2.2kg	0.0089	380x470x50	
	1	1.95kg	2.4kg	0.0104	560x745x25	
Product		481x681	544x1922xØ420			

10.479

Graphic Size: 500x700

### COMBI ONE 2SIDED

\* W: Width H: Height D: Depth \*mm



	QTY	N.W	G.W	C.B.M	Size (WxHxD)	
Packing	1	2.8kg	3.6kg	0.0123	80x1920x80	 x6 
	1	8.2kg	8.5kg	0.0097	440x440x50	
	2	1.95kg	2.2kg	0.0089	380x470x50	
	2	1.95kg	2.4kg	0.0104	560x745x25	
Product		481x681	544x1922xØ420			

10.480

Graphic Size: 500x700 (x2)

### COMBI TWO 1SIDED

\* W: Width H: Height D: Depth \*mm



	QTY	N.W	G.W	C.B.M	Size (WxHxD)	
Packing	1	2.8kg	3.6kg	0.0123	80x1920x80	 x5 
	1	8.2kg	8.5kg	0.0097	440x440x50	
	2	1.95kg	2.2kg	0.0089	380x470x50	
	1	1.95kg	2.4kg	0.0104	560x745x25	
Product		481x681	544x1922xØ420			

10.485

Graphic Size: 500x700

### COMBI TWO 2SIDED

\* W: Width H: Height D: Depth \*mm

	QTY	N.W	G.W	C.B.M	Size (WxHxD)	
Packing	1	2.8kg	3.6kg	0.0123	80x1920x80	 x8 
	1	8.2kg	8.5kg	0.0097	440x440x50	
	4	1.95kg	2.2kg	0.0089	380x470x50	
	2	1.95kg	2.4kg	0.0104	560x745x25	
Product		481x681	544x1922xØ420			

10.486



Graphic Size: 500x700 (x2)

## COMBI THREE



single or double-sided option



### COMBI THREE 1SIDED \* W: Width H: Height D: Depth \*mm

	QTY	N.W	G.W	C.B.M	Size (WxHxD)	
Packing	1	2.8kg	3.6kg	0.0123	80x1920x80	 x5 
	1	8.2kg	8.5kg	0.0097	440x440x50	
	3	1.95kg	2.2kg	0.0089	380x470x50	
	External (WxHxD)					
Product	460x1922xØ420					
10.483						

### COMBI THREE 2SIDED \* W: Width H: Height D: Depth \*mm



	QTY	N.W	G.W	C.B.M	Size (WxHxD)	
Packing	1	2.8kg	3.6kg	0.0123	80x1920x80	 x8 
	1	8.2kg	8.5kg	0.0097	440x440x50	
	6	1.95kg	2.2kg	0.0089	380x470x50	
	External (WxHxD)					
Product	544x1922xØ420					
10.484						

## COMBI FOUR

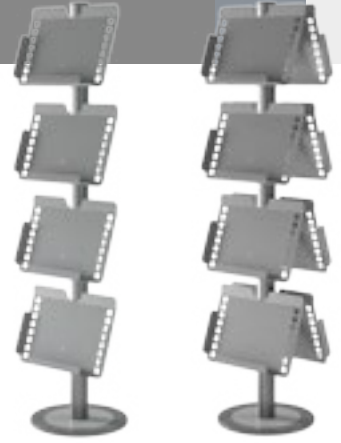

single or double-sided option



### COMBI FOUR 1SIDED \* W: Width H: Height D: Depth \*mm

	QTY	N.W	G.W	C.B.M	Size (WxHxD)	
Packing	1	2.8kg	3.6kg	0.0123	80x1920x80	 x6 
	1	8.2kg	8.5kg	0.0097	440x440x50	
	4	1.95kg	2.2kg	0.0089	380x470x50	
	External (WxHxD)					
Product	544x1922xØ420					
10.481						

### COMBI FOUR 2SIDED \* W: Width H: Height D: Depth \*mm



	QTY	N.W	G.W	C.B.M	Size (WxHxD)	
Packing	1	2.8kg	3.6kg	0.0123	80x1920x80	 x10 
	1	8.2kg	8.5kg	0.0097	440x440x50	
	8	1.95kg	2.2kg	0.0089	380x470x50	
	External (WxHxD)					
Product	544x1922xØ420					
10.482						

## COMBI MIX

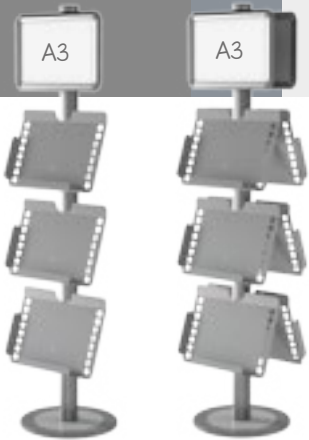

single or double-sided option



### COMBI MIX 1SIDED \* W: Width H: Height D: Depth \*mm

	QTY	N.W	G.W	C.B.M	Size (WxHxD)	
Packing	1	2.8kg	3.6kg	0.0123	80x1920x80	 x6 
	1	8.2kg	8.5kg	0.0097	440x440x50	
	3	1.95kg	2.2kg	0.0089	380x470x50	
	1	1kg	1.2kg	0.0061	365x480x35	
	Visual (X-Y)		External (WxHxD)			
Product	481x681		544x1922xØ420			
10.487	Graphic Size: A3					

### COMBI MIX 2SIDED \* W: Width H: Height D: Depth \*mm

	QTY	N.W	G.W	C.B.M	Size (WxHxD)	
Packing	1	2.8kg	3.6kg	0.0123	80x1920x80	 x10 
	1	8.2kg	8.5kg	0.0097	440x440x50	
	6	1.95kg	2.2kg	0.0089	380x470x50	
	2	1kg	1.2kg	0.0061	365x480x35	
	Visual (X-Y)		External (WxHxD)			
Product	278x402		460x1922xØ420			
10.488	Graphic Size: A3 (x2)					

## COMBI FRAME

single or double-sided option

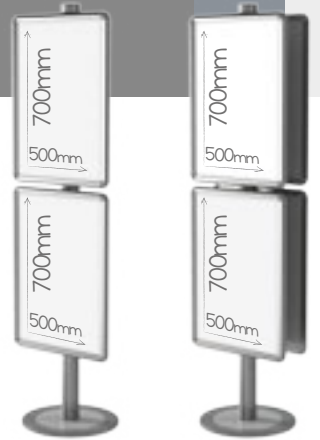

### COMBI FRAME 1SIDED \* W: Width H: Height D: Depth \*mm

	QTY	N.W	G.W	C.B.M	Size (WxHxD)	
Packing	1	2.8kg	3.6kg	0.0123	80x1920x80	 x4 
	1	8.2kg	8.5kg	0.0097	440x440x50	
	2	1.95kg	2.4kg	0.0104	560x745x25	
	Visual (X-Y)		External (WxHxD)			
Product	481x681		544x1922xØ420			
10.489	Graphic Size: 500x700					

### COMBI FRAME 2SIDED \* W: Width H: Height D: Depth \*mm

	QTY	N.W	G.W	C.B.M	Size (WxHxD)	
Packing	1	2.8kg	3.6kg	0.0123	80x1920x80	 x6 
	1	8.2kg	8.5kg	0.0097	440x440x50	
	4	1.95kg	2.4kg	0.0104	560x745x50	
		Visual (X-Y)		External (WxHxD)		
Product	481x681		544x1922xØ420			
10.490	Graphic Size: 500x700 (x2)					

STAND DETAILS



DIMENSIONS

\* W: Width H: Height D: Depth \* mm

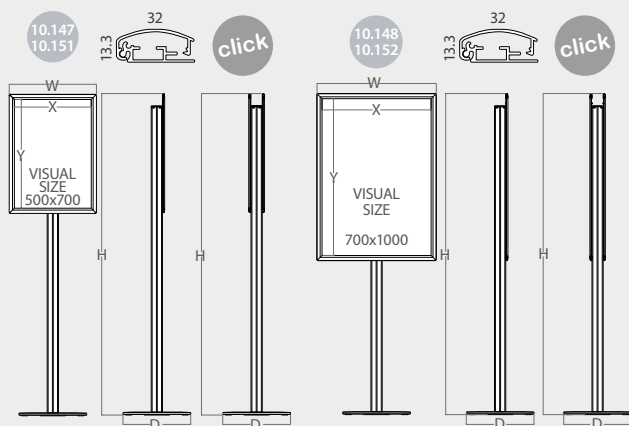

INFORMATION



Sign displays can be used in a variety of indoor locations to showcase eye-catching graphics and signage. It features a 8kg weight steel base and click system frame. Simply flip open the frames' molding and slide your graphics behind the non-glare lenses. These sign displays are made of aluminum and feature a smooth silver finish. Also double-sided presentation is available.

PLASENCIA



PLASENCIA H700



\* W: Width H: Height D: Depth \*mm

	QTY	N.W	G.W	C.B.M	Size (WxHxD)	
Packing	1	2.8kg	3.6kg	0.0123	80x1920x80	 x3 
	1	8.2kg	8.5kg	0.0097	440x440x50	
	1	1.5kg	2kg	0.0104	560x745x25	
	Visual (X-Y)		External (WxHxD)			
Product	478x678		540x1922x Ø420			

10.147 Graphic Size: 500x700 x 1uni.

PLASENCIA H1000



\* W: Width H: Height D: Depth \*mm

	QTY	N.W	G.W	C.B.M	Size (WxHxD)	
Packing	1	2.8kg	3.6kg	0.0123	80x1920x80	 x3 
	1	8.2kg	8.5kg	0.0097	440x440x50	
	1	2.55kg	3.25kg	0.0123	80x1920x80	
	Visual (X-Y)		External (WxHxD)			
Product	678x978		740x1922x Ø420			

10.148 Graphic Size: 700x1000 x 1uni.

PLASENCIA H700 DOUBLE



\* W: Width H: Height D: Depth \*mm

	QTY	N.W	G.W	C.B.M	Size (WxHxD)	
Packing	1	2.8kg	3.6kg	0.0123	80x1920x80	 x4 
	1	8.2kg	8.5kg	0.0097	440x440x50	
	2	1.5kg	2kg	0.0104	560x745x25	
	Visual (X-Y)		External (WxHxD)			
Product	478x678		540x1922x Ø420			

10.151 Graphic Size: 500x700 x 2uni.

PLASENCIA H1000 DOUBLE

\* W: Width H: Height D: Depth \*mm

	QTY	N.W	G.W	C.B.M	Size (WxHxD)	
Packing	1	2.8kg	3.6kg	0.0123	80x1920x80	 x4 
	1	8.2kg	8.5kg	0.0097	440x440x50	
	2	2.55kg	3.25kg	0.0123	80x1920x80	
	Visual (X-Y)		External (WxHxD)			
Product	678x978		740x1922x Ø420			

10.152 Graphic Size: 700x1000 x 2uni.



STAND DETAILS



DIMENSIONS

\* W: Width H: Height D: Depth \* mm

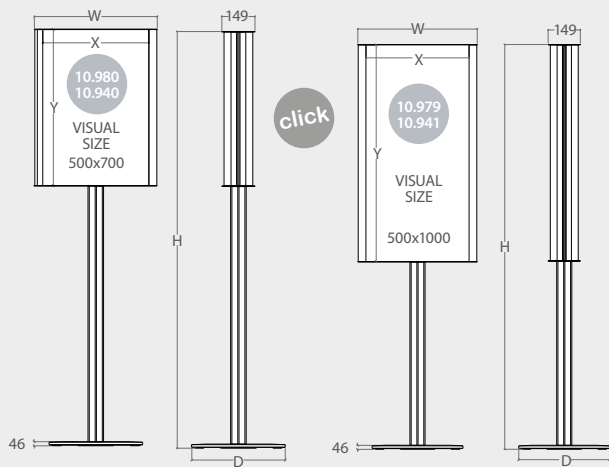

INFORMATION

The Leinster double-sided display is built from sturdy, durable aluminum frame. With an easy-to-use snap frame and edge-lit LED bulbs, Leinster lightbox stand is useful for darker venues, such as halls and movie theaters. The convex holder helps graphics pop out, ensuring that the double sided poster display can be seen from any angle. Designed for day or night time use, Leinster is available without light.

LEINSTER



LEINSTER H700

\* W: Width H: Height D: Depth \*mm

	QTY	N.W	G.W	C.B.M	Size (WxHxD)	
Packing	1	18.75kg	21.3kg	0.1202	1095x610x180	
	1	8.2kg	8.5kg	0.009	440x440x50	
Product	Visual (X-Y)		External (WxHxD)			
	476x700		552x1868x Ø420			
10.980	Graphic Size: 500x700					



LEINSTER H1000

\* W: Width H: Height D: Depth \*mm

	QTY	N.W	G.W	C.B.M	Size (WxHxD)	
Packing	1	18.75kg	21.3kg	0.1202	1095x610x180	
	1	8.20kg	8.5kg	0.009	440x440x50	
Product	Visual (X-Y)		External (WxHxD)			
	476x1000		552x1868x Ø420			
10.979	Graphic Size: 500x1000					



LEINSTER H700 LED

\* W: Width H: Height D: Depth \*mm

	QTY	N.W	G.W	C.B.M	Size (WxHxD)	
Packing	1	18.75kg	21.3kg	0.1202	1095x610x180	 
	1	8.2kg	8.5kg	0.009	440x440x50	
Product	Visual (X-Y)		External (WxHxD)			
	476x700		552x1868x Ø420			
10.940	Graphic Size: 500x700					

LEINSTER H1000 LED

\* W: Width H: Height D: Depth \*mm

	QTY	N.W	G.W	C.B.M	Size (WxHxD)	
Packing	1	18.75kg	21.3kg	0.1202	1095x610x180	 
	1	8.20kg	8.5kg	0.009	440x440x50	
Product	Visual (X-Y)		External (WxHxD)			
	476x1000		552x1868x Ø420			
10.941	Graphic Size: 500x1000					

## TOTEM DETAILS



## DIMENSIONS

\* W: Width H: Height D: Depth \* mm

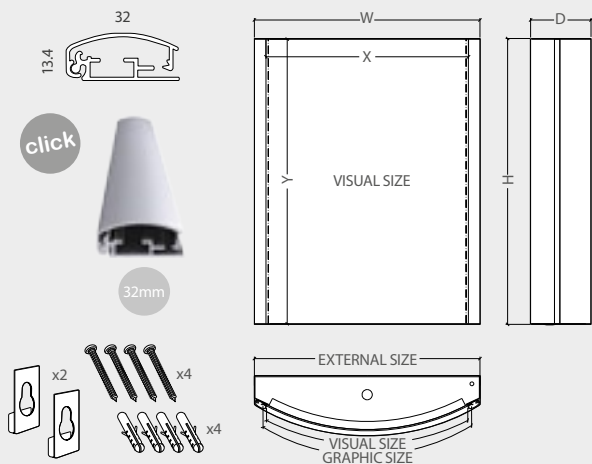

## INFORMATION

The Genova Light Wall Totem features a high quality anodized aluminum poster frame along with an accompanying satin metal base. Its Click System allows an easy and quick poster change. The poster holder display, which is a curved sign holder also features backlit LED illumination. Designed for day or night time use, the illuminated lightbox stand has clear PVC lens to prevent glare. Ideal for using at hospitals, clinics, academies, darker halls or movie theaters.

## GENOVA LIGHT TOTEM



### GENOVA 700 LED

\* W: Width H: Height D: Depth \*mm

	QTY	N.W	G.W	C.B.M	Size (WxHxD)
Packing	1	9.4kg	10.9kg	0.0918	600x765x200
	Visual (X-Y)		External (WxHxD)		
Product	518x707		710x560x150		
10.117	Visual: 500x700mm		Graphic Size: 539x707mm		

### GENOVA 1000 LED

\* W: Width H: Height D: Depth \*mm

	QTY	N.W	G.W	C.B.M	Size (WxHxD)
Packing	1	15.05kg	17.45kg	0.1758	805x1065x205
	Visual (X-Y)		External (WxHxD)		
Product	712x10007		760x1010x150		
10.348	Visual: 700x1000mm		Graphic Size: 734x1007mm		

TOTEM DETAILS



INFORMATION

\* W: Width H: Height D: Depth \* mm

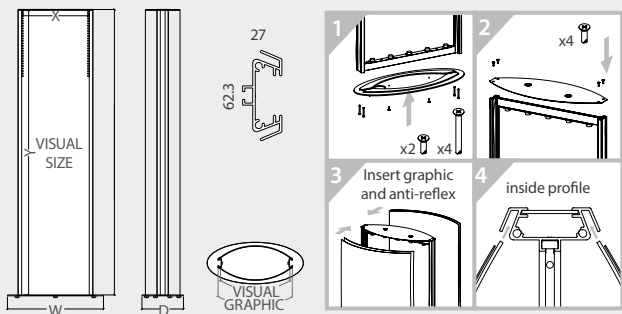

INFORMATION

The Obidos double-sided Totem is built from sturdy, durable silver anodized aluminum with a steel base. Designed with a convex display and brilliant illumination for day or night use (PVC lens to prevent glare is included). Ideal for restaurants, clinics, academies, darker halls or movie theaters. Anti-reflective plastic included. Obidos is sure attract the attention of your target audience.

OBIDOS H1600

\* W: Width H: Height D: Depth \*mm

	QTY	N.W	G.W	C.B.M	Size (WxHxD)	
Packing	1	9.46kg	11.70kg	0.1078	570x1645x115	 x2
	1	5.30kg	5.65kg	0.0054	565x275x35	
		Visual (X-Y)		External (WxHxD)		
Product	488x1600	540x1610x234				
10.221	Totem: 500x1600mm		Graphic Size: 516x1600mm			

OBIDOS H1800

\* W: Width H: Height D: Depth \*mm

	QTY	N.W	G.W	C.B.M	Size (WxHxD)	
Packing	1	13.20kg	16.10kg	0.14	660x1845x115	 x2
	1	6.05kg	6.45kg	0.0072	665x310x35	
		Visual (X-Y)		External (WxHxD)		
Product	602x1800	640x1810x277				
10.222	Totem: 600x1800mm		Graphic Size: 630x1800mm			

OBIDOS LIGHT TOTEM



OBIDOS H2000

\* W: Width H: Height D: Depth \*mm

	QTY	N.W	G.W	C.B.M	Size (WxHxD)	
Packing	1	16kg	19.40kg	0.1764	750x2045x115	 x2
	1	10kg	10.50kg	0.0095	765x355x35	
		Visual (X-Y)		External (WxHxD)		
Product	703x2000	740x2010x320				
10.223	Totem: 700x2000mm		Graphic Size: 731x2000mm			

## TOTEM DETAILS



## DIMENSIONS

\* W: Width H: Height D: Depth \* mm

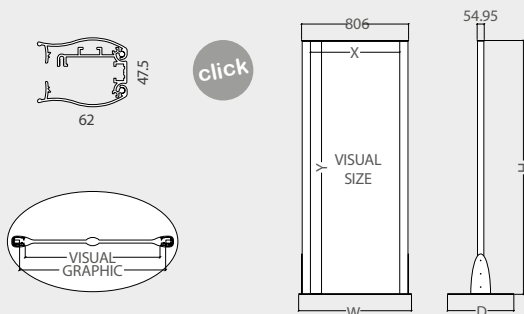

The Cascais double-sided Totem is built from sturdy, durable silver anodized aluminum with steel base. Designed for day or night time use, the illuminated lightbox stand has clear PVC lens to prevent glare. This Totem is freestanding and is very well suited as display frame for advertising in retail locations, restaurants, clinics or exhibitions. Anti-reflective plastic included. Cascais lightbox stand is useful for darker halls or movie theaters.

## CASCAIS \* W: Width H: Height D: Depth \*mm

	QTY	N.W	G.W	C.B.M	Size (WxHxD)	
Packing	1	19.25kg	21.9kg	0.1579	850x1955x95	 x2
	1	14.85kg	15.75kg	0.0213	875x540x45	
	Visual (X-Y)		External (WxHxD)			
Product	672x1900		850x1910x500			
10.356	Totem: 700x1900mm		Graphic Size: 728x1900mm			

## CASCAIS LED \* W: Width H: Height D: Depth \*mm

	QTY	N.W	G.W	C.B.M	Size (WxHxD)	
Packing	1	20.45kg	23.1kg	0.1579	850x1955x95	 x2 
	1	14.85kg	15.75kg	0.0213	875x540x45	
	Visual (X-Y)		External (WxHxD)			
Product	672x1900		850x1910x500			
10.354	Totem: 700x1900mm		Graphic Size: 728x1900mm			

## CASCAIS LIGHT TOTEM



## TOTEM DETAILS



with /  
without  
LED

## INFORMATION

\* W: Width H: Height D: Depth \* mm

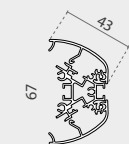

click

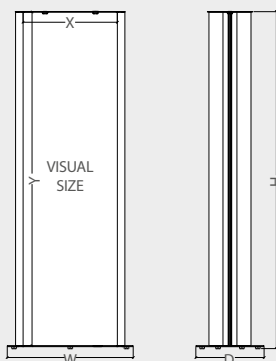
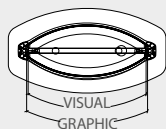

The Nantes Totem is built from sturdy, durable silver anodized aluminum with steel base. Designed for day or night time use (PVC lens included). Anti-reflective plastic included. Ideal for restaurants, clinics, darker halls or movie theaters.

## NANTES LIGHT TOTEM



### NANTES H1200 \* W: Width H: Height D: Depth \*mm

	QTY	N.W	G.W	C.B.M	Size (WxHxD)	
Packing	1	8.25kg	10.1kg	0.0816	570x1245x115	 x2
	1	7.65kg	8.65kg	0.0077	620x355x35	
	Visual (X-Y)		External (WxHxD)			
Product	485x1200		600x1217x325			

10.602 Totem: 500x1200mm Graphic: 524x1200mm

### NANTES H1600 \* W: Width H: Height D: Depth \*mm

	QTY	N.W	G.W	C.B.M	Size (WxHxD)	
Packing	1	9.5kg	11.45kg	0.1078	570x1645x115	 x2
	1	7.65kg	8.65kg	0.0077	620x355x35	
	Visual (X-Y)		External (WxHxD)			
Product	485x1600		600x1617x325			

10.436 Totem: 500x1600mm Graphic: 524x1600mm

### NANTES H1800 \* W: Width H: Height D: Depth \*mm

	QTY	N.W	G.W	C.B.M	Size (WxHxD)	
Packing	1	14.6kg	17kg	0.14	660x1845x115	 x2
	1	9.95kg	11.05kg	0.0101	720x400x35	
	Visual (X-Y)		External (WxHxD)			
Product	588x1800		700x1817x370			



10.460 Totem: 600x1800mm Graphic: 626x1800mm

### NANTES W700xH1800 \* W: Width H: Height D: Depth \*mm

	QTY	N.W	G.W	C.B.M	Size (WxHxD)	
Packing	1	15.95kg	18.55kg	0.1570	740x1845x115	 x2
	1	13.4kg	14.55kg	0.0132	820x460x35	
	Visual (X-Y)		External (WxHxD)			
Product	695x1800		800x1817x427			



10.521 Totem: 700x1800mm Graphic: 724x1800mm

### NANTES H1200 LED \* W: Width H: Height D: Depth \*mm

	QTY	N.W	G.W	C.B.M	Size (WxHxD)	
Packing	1	9.35kg	11.2kg	0.0816	570x1245x115	 x2 
	1	7.65kg	8.65kg	0.0077	620x355x35	
	Visual (X-Y)		External (WxHxD)			
Product	485x1200		600x1217x325			



10.402 Totem: 500x1200mm Graphic: 524x1200mm

### NANTES H1600 LED \* W: Width H: Height D: Depth \*mm

	QTY	N.W	G.W	C.B.M	Size (WxHxD)	
Packing	1	10.5kg	12.45kg	0.1078	570x1645x115	 x2 
	1	7.65kg	8.65kg	0.0077	620x355x35	
	Visual (X-Y)		External (WxHxD)			
Product	485x1600		600x1617x325			



10.464 Totem: 500x1600mm Graphic: 524x1600mm

### NANTES 1800 LED \* W: Width H: Height D: Depth \*mm

	QTY	N.W	G.W	C.B.M	Size (WxHxD)	
Packing	1	15.6kg	18kg	0.14	660x1845x115	 x2 
	1	9.95kg	11.05kg	0.0101	720x400x35	
	Visual (X-Y)		External (WxHxD)			
Product	588x1800		700x1817x370			

10.465 Totem: 600x1800mm Graphic: 626x1800mm

### NANTES W700xH1800 LED \* W: Width H: Height D: Depth \*mm

	QTY	N.W	G.W	C.B.M	Size (WxHxD)	
Packing	1	16.95kg	19.55kg	0.1570	740x1845x115	 x2 
	1	13.4kg	14.55kg	0.0132	820x460x35	
	Visual (X-Y)		External (WxHxD)			
Product	695x1800		800x1817x427			

10.556 Totem: 700x1800mm Graphic: 724x1800mm

### TOTEM DETAILS



### DIMENSIONS

\* W: Width H: Height D: Depth \* mm

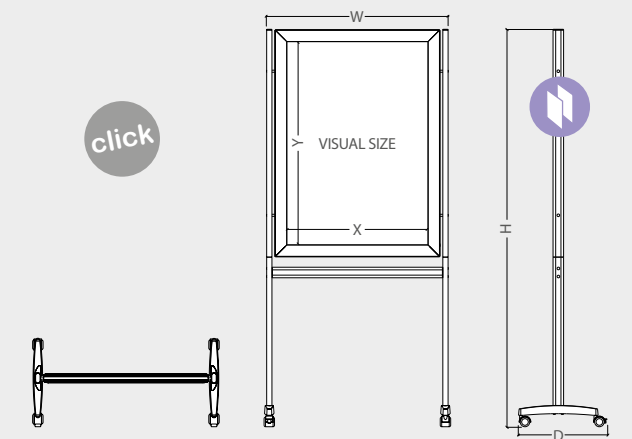

### INFORMATION

Designed for day or night time use, Sintra Info Stand is built from sturdy, durable aluminum frame, with a 32mm width Click System profile and edge-lit LED bulbs. Also, it has brake wheels and a resistant antireflection sheet. Ideal for tradeshows, medical clinics, academies, highly-populated lobbies, travel agencies, darker venues, movie theaters, libraries or for waiting rooms.

## SINTRA



SINTRA		* W: Width	H: Height	D: Depth	* mm
	QTY	N.W	G.W	C.B.M	Size (WxHxD)
Packing	1	16.5kg	19.95kg	0.01455	920x140x1130
	Visual (X-Y)	External (WxHxD)			
Product	683x983	900x1925x430			
10.313	Graphic Size: 700x1000mm				

SINTRA LED LIGHT		* W: Width	H: Height	D: Depth	* mm
	QTY	N.W	G.W	C.B.M	Size (WxHxD)
Packing	1	20.35kg	22.7kg	0.01455	920x140x1130
	Visual (X-Y)	External (WxHxD)			
Product	683x983	900x1925x430			
10.767	Graphic Size: 700x1000mm				

TOTEM DETAILS



INFORMATION

\* W: Width H: Height D: Depth \* mm

Almendralejo Info Stand is designed to be used with brochure advertising. It has a 32mm width profile with click system. Also Resistant antireflection sheet and brake wheels. Ideal for tradeshows, clinics, academies, highly-populated lobbies, travel agencies, libraries or waiting rooms to provide reading material to clients.

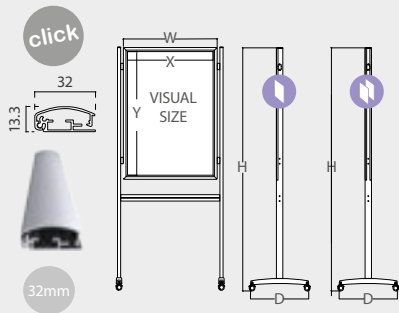

BROCHURE HOLDERS OPTIONS

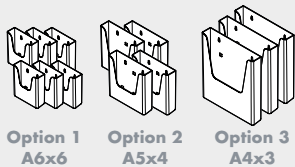

You can choose between 3 options to set-up your brochure holders:

- 6 Brochure Holders A6 size format.
- 4 Brochure Holders A5 size format.
- 3 Brochure Holders A4 size format.

ALMENDRALEJO

\* W: Width H: Height D: Depth \*mm

	QTY	N.W	G.W	C.B.M	Size (WxHxD)	
Packing	1	8.6kg	10.9kg	0.1258	860x1950x75	
		Visual (X-Y)	External (WxHxD)			
Product	677x977	834x1920x460				

10.160 Graphic Size: 700x1000mm

ALMENDRALEJO 2-SIDED

\* W: Width H: Height D: Depth \*mm

	QTY	N.W	G.W	C.B.M	Size (WxHxD)	
Packing	1	10.3kg	13.5kg	0.1258	860x1950x75	
		Visual (X-Y)	External (WxHxD)			
Product	677x977	834x1920x460				

10.759 Graphic Size: 700x1000mm

ALMENDRALEJO



POLAN



STAND DETAILS



DIMENSIONS

\* W: Width H: Height D: Depth \* mm

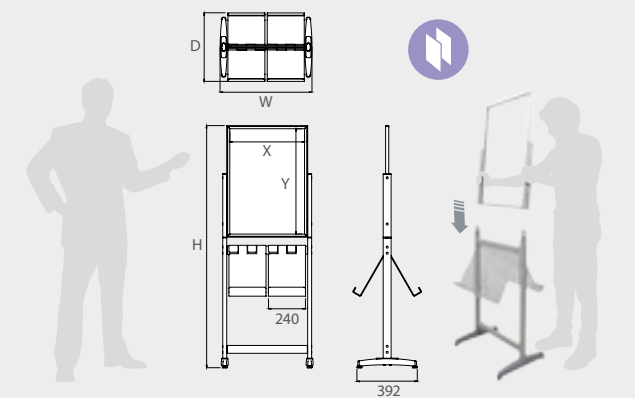

INFORMATION

The Double-sided Polan Info Stand is made of aluminium. There are two available models: without shelves (Ref: 13.862) and with 4 acrylic shelves for 4x A4 format literature documents (Ref: 13.599) like brochures, magazines, or newspapers. Also it features an aluminium frame header at the top. With adjustable leveling feet and an easy glide for the graphic poster (9mm maximum thickness) into the metal grooves of the structure and display it back-to-back.

POLAN WITHOUT SHELVES \* W: Width H: Height D: Depth \*mm

	QTY	N.W	G.W	C.B.M	Size (WxHxD)
Packing	1	4.41kg	5.67kg	0.0614	880x665x105
		Visual (X-Y)	External (WxHxD)		
Product	485x683	596.5x1569x446			
13.862	Top Header Graphic Size: 500x700mm				



POLAN WITH SHELVES \* W: Width H: Height D: Depth \*mm

	QTY	N.W	G.W	C.B.M	Size (WxHxD)
Packing	1	6.77kg	8.47kg	0.0614	880x665x105
		Visual (X-Y)	External (WxHxD)		
Product	485x683	596.5x1569x446			
13.599	Top Header Graphic Size: 500x700mm				



4x A4 brochures holders

leveling feet



STAND DETAILS

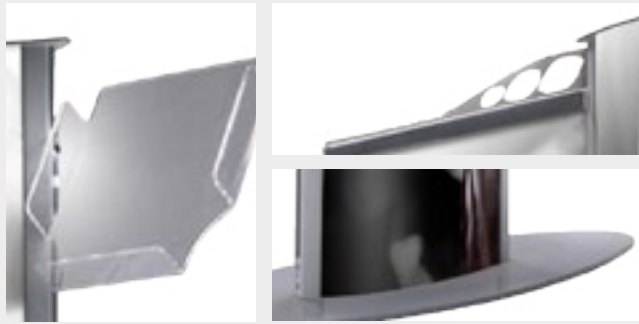

INFORMATION

\*mm

Cañada is made of aluminium with 4 acrylic shelves for A4 documents. It features a double-sided large poster holder. Perfect for using in highly populated lobbies, travel agencies, libraries or for waiting rooms to provide reading material to the clients, also thanks to its LED Light, it's ideal for darker halls or movie theaters.

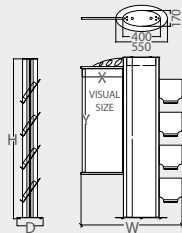

CAÑADA

\* W: Width H: Height D: Depth \*mm

	QTY	N.W	G.W	C.B.M	Size (WxHxD)
Packing	1	18.5kg	19.7kg	0.3752	652x345x1740
		Visual (X-Y)	External (WxHxD)		
Product	Totem: 308x1699		1074x1700x280		
	Totem: 430x1109				
10.470	Totem Graphic Size: 324x1700mm Poster Graphic Size: 430x1100mm				

CAÑADA



double sided



4x A4 holders

made of aluminium and acrylic supports

STAND DETAILS



made of aluminium

INFORMATION

\*mm

Hito is made of silver finish aluminium with 3 acrylic shelves for A4 documents. It features a solid and stable 8kg weight steel base and a double-sided large poster holder. Ideal for using in highly populated lobbies, travel agencies, libraries or for waiting rooms to provide reading material to the visiting clients.

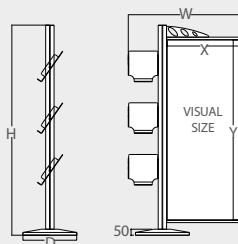

HITO

\* W: Width H: Height D: Depth \*mm

	QTY	N.W	G.W	C.B.M	Size (WxHxD)
Packing	1	2.8kg	3.6kg	0.0123	80x1920x80
	1	8.2kg	8.5kg	0.0097	440x440x50
	1	1.6kg	1.9kg	0.0190	390x650x75
	Visual (X-Y)	External (WxHxD)			
Product	600x1500		930x1753x450		
10.471	Graphic Size: 600x1510mm				

HITO



3x A4 holders

double faced

8 kg steel base



# LITERATURE STAND Literature Stands

## STAND DETAILS



## INFORMATION

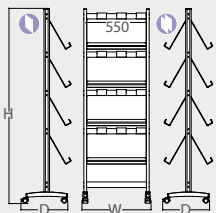

\*mm

Cañamo has wheels and it is made of aluminium with acrylic shelves. The 1-sided model has 4 shelves for 8xA4 documents and 2-sided: 8 shelves for 16xA4 documents, like brochures, journals or newspapers. Ideal for using in highly-populated lobbies, travel agencies, libraries or waiting rooms to provide literature for clients.



## CAÑAMO

\* W: Width H: Height D: Depth \*mm

	QTY	N.W	G.W	C.B.M	Size (WxHxD)	
Packing	1	7.3kg	9kg	0.0487	165x720x410	 x2
	1	6.45kg	8.05kg	0.0772	70x1750x630	
	External (WxHxD)					
Product	629x1769x487					
10.468		1-Sided (8xA4)				
14.098		2-Sided (16xA4)				

## CAÑAMO



made of acrylic and aluminium

2 sided available



brake wheels



## STAND DETAILS



## INFORMATION

\*mm

Abad has wheels and it is made of aluminium with acrylic shelves. The 1-sided model has 4 shelves for 8xA4 documents and 2-sided: 8 shelves for 16xA4 documents. Also it has a "Click" frame header at the top. Ideal for using in highly-populated lobbies, travel agencies, libraries or waiting rooms to provide literature for clients.

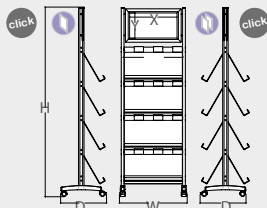

## ABAD

\* W: Width H: Height D: Depth \*mm

	QTY	N.W	G.W	C.B.M	Size (WxHxD)	
Packing	1	7.3kg	9kg	0.0487	165x720x410	 x2
	1	6.45kg	8.05kg	0.0772	70x1750x630	
	Visual (X-Y)		External (WxHxD)			
Product	466x236		629x1769x487			
10.467		Top Header Graphic Size: 488x257mm				
14.099		Top Headers Graphic Size: 488x257mm (x2)				

## ABAD



- EN With a "Click" aluminium header frame at the top.
- FR Avec un cadre "Click" dans la partie supérieure.
- PT Possui um marco "Click" na parte superior.
- ES Dispone de un marco "Click" en su parte superior.

2 sided available



brake wheels



# LITERATURE STAND Literature Stands

## STAND DETAILS



## INFORMATION

\*mm

Sotillo Stand is made of aluminium with 4 acrylic shelves for 12xA4 documents. It features a "Click" frame header at the top. Also It is equipped with 4 brake wheels. Ideal for using in highly-populated lobbies, travel agencies, libraries or for waiting rooms to provide reading material to the clients.

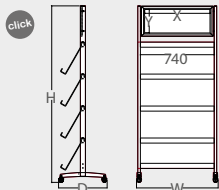

## SOTILLO

\* W: Width H: Height D: Depth \*mm

	QTY	N.W	G.W	C.B.M	Size (WxHxD)	
Packing	1	9kg	10.5kg	0.062	410x920x165	 x2
	1	7.35kg	9.35kg	0.101	830x1750x70	
Product	Visual (X-Y)		External (WxHxD)			
	656x236		819x1769x487			
10.469	Graphic Size: 677x257mm					

## SOTILLO



- EN With a "Click" aluminium header frame at the top.
- FR Avec un cadre "Click" dans la partie supérieure.
- PT Possui um marco de abertura "Click" na parte superior.
- ES Dispone de un marco "Click" en su parte superior.

for 12xA4 brochures

made of acrylic and aluminium

brake wheels



## STAND DETAILS

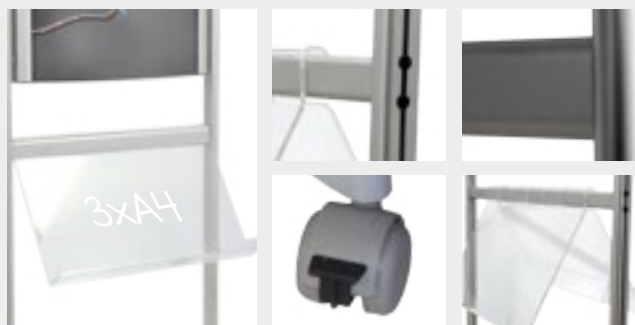

## INFORMATION

\*mm

Olmedilla is made of aluminium with 1 acrylic shelf for 3xA4 documents. It features a 2-sided "Click" frame board (2 sizes available). Also It has 4 brake wheels. Ideal for using in highly populated lobbies, travel agencies, libraries or for waiting rooms to provide reading material to the clients.

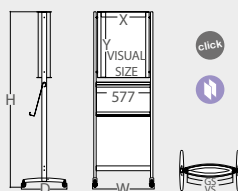

## OLMEDILLA H700

\* W: Width H: Height D: Depth \*mm

	QTY	N.W	G.W	C.B.M	Size (WxHxD)	
Packing	1	11.5kg	13.4kg	0.243	1825x205x650	 x2
	Visual (X-Y)		External (WxHxD)			
Product	476x696		655x1864x487			
10.472	Top Header Graphic Size: 500x700mm					

## OLMEDILLA H1000

\* W: Width H: Height D: Depth \*mm

	QTY	N.W	G.W	C.B.M	Size (WxHxD)	
Packing	1	17kg	18.5kg	0.372	850x1825x240	 x2
	Visual (X-Y)		External (WxHxD)			
Product	690x996		856x1864x487			
10.273	Top Header Graphic Size: 700x1000mm					

## OLMEDILLA



- EN With a "Click" aluminium header frame at the top.
- FR Avec un cadre "Click" dans la partie supérieure.
- PT Possui um marco de abertura "Click" na parte superior.
- ES Dispone de un marco "Click" en su parte superior.

double sided

made of acrylic and aluminium

brake wheels



## STAND DETAILS



## INFORMATION

\*mm

The Verona Brochure stand is made of aluminium with acrylic shelves and it has 4 shelves for A4 format documents. Also it has a top acrylic header for a 255x147mm graphic. It is ideal for using in highly populated lobbies, at travel agencies, libraries or for waiting rooms to provide reading material to the visiting clients.

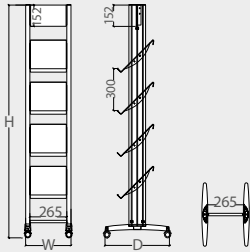

## VERONA 4xA4

\* W: Width H: Height D: Depth \*mm

	QTY	N.W	G.W	C.B.M	Size (WxHxD)	
Packing	1	3kg	3.95kg	0.0307	420x430x170	 x2
	1	4.45kg	5kg	0.0118	145x1620x80	
	External (WxHxD)					
Product	325x1660x380					
10.217	Top Header Graphic Size: 255x147mm					

## VERONA 4x4



with acrylic header at the top

with 4x4 brochures



brake wheels



## STAND DETAILS

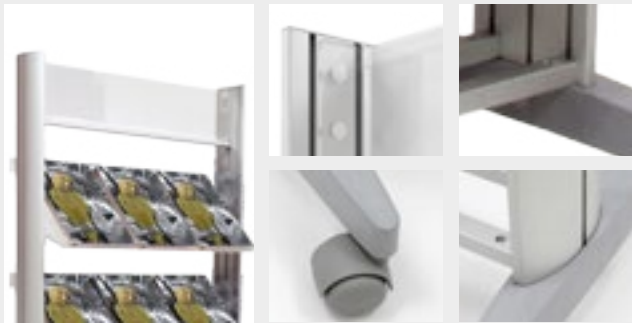

## INFORMATION

\*mm

Verona Stand is made of aluminium with acrylic shelves. This model has 4 shelves for 12 xA4 format documents. Also it has a top acrylic header for a 730x147mm graphic and wheels. Ideal for using in highly-populated lobbies, travel agencies, libraries or for waiting rooms to provide reading material to the visiting clients.

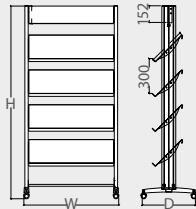

## VERONA 12xA4

\* W: Width H: Height D: Depth \*mm

	QTY	N.W	G.W	C.B.M	Size (WxHxD)	
Packing	1	3kg	3.95kg	0.0307	420x430x170	 x2
	1	4.45kg	5kg	0.0118	145x1620x80	
	External (WxHxD)					
Product	800x1660x380					
10.218	Top Header Graphic Size: 730x147mm					

## VERONA 12x4



made of acrylic and aluminium

with 12xA4 brochures



brake wheels



STAND DETAILS



DIMENSIONS

\* W: Width H: Height D: Depth \* mm

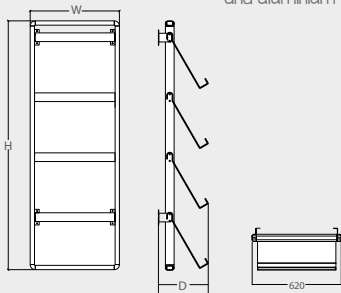

made of acrylic and aluminium

INFORMATION

Athy Brochure Wall Holder has 4 shelves and it is designed to accommodate 2xA4 portrait format documents by shelf. The magazine rack is wall mounting, giving you more floor space while still providing passersby with information. This type of rack system allows you to adjust the literature holders to the size you need. In this manner, it is up and out of your way, while remaining at eye level for your customers. Athy Holder is ideal for an office or lobby. Also see it in waiting rooms to hold your magazines and newspapers, or in information centers, travel bureaus and clinics to hold your brochures.

ATHY

\* W: Width H: Height D: Depth \* mm

	QTY	N.W	G.W	C.B.M	Size (WxHxD)
Packing	1	11.7kg	13.4kg	0.1742	185x1500x650
					External (WxHxD)
Product					620x1450x290
10.988					

ATHY

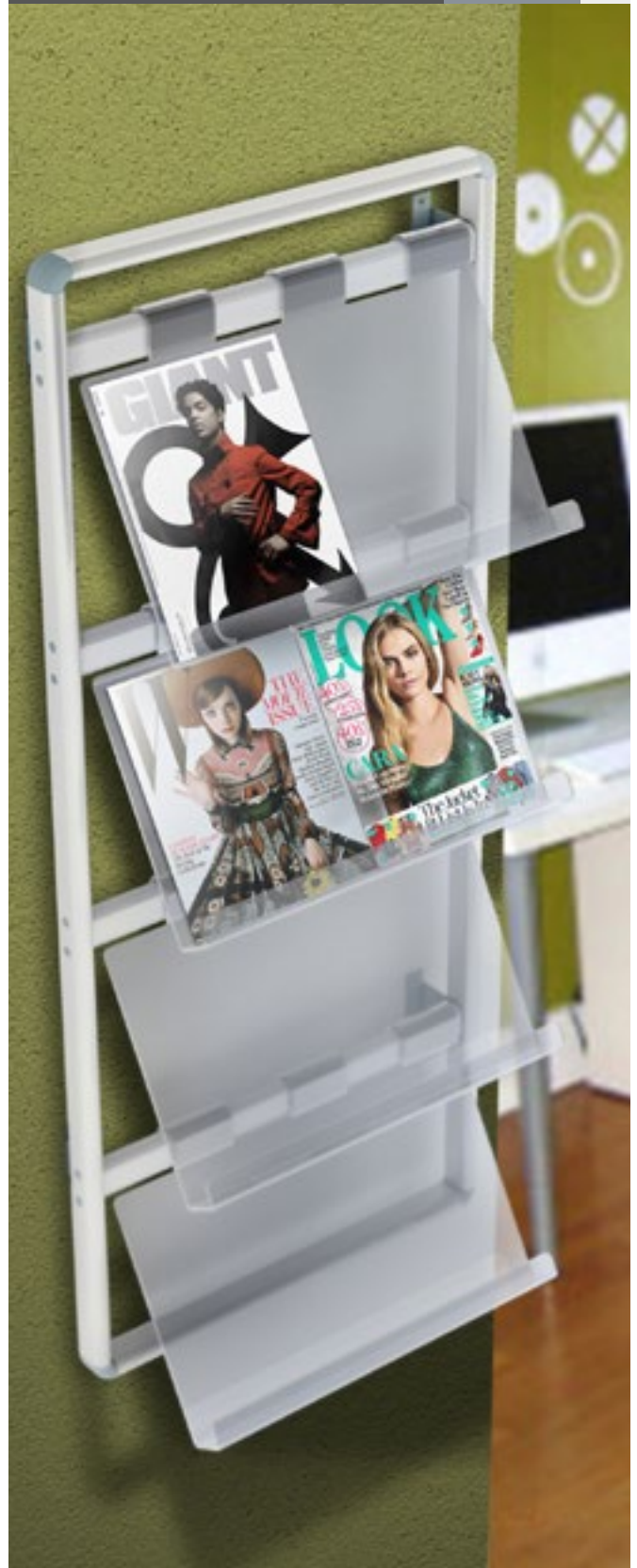

## STAND DETAILS



## DIMENSIONS

\* W: Width H: Height D: Depth \* mm

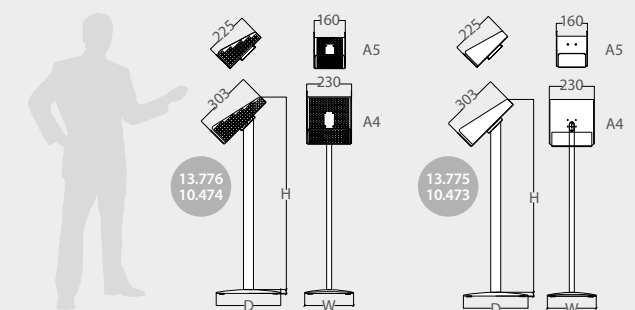

## INFORMATION

The Sagres brochure tray stand features acrylic or steel literature holder (depending on model) available for A4 or A5 format documents, an aluminium profile structure with a highly resistant and solid base, which ensures that the unit stays upright in heavily trafficked areas. The silver finish provides a neutral tone that will complement any commercial environment. Ideal for tradeshows, mall stores, exhibitions or places with a high traffic area.

## SAGRES METALLIC

\* W: Width H: Height D: Depth \*mm

	QTY	N.W	G.W	C.B.M	Size (WxHxD)
Packing	1	3.2kg	3.5kg	0.0322	295x120x910
	External (WxHxD)				
Product	± 250x1000x330				
13.776	Brochure Holder Size: A5				
10.474	Brochure Holder Size: A4				

## SAGRES ACRYLIC

\* W: Width H: Height D: Depth \*mm

	QTY	N.W	G.W	C.B.M	Size (WxHxD)
Packing	1	3.1kg	3.4kg	0.0322	295x120x910
	External (WxHxD)				
Product	± 250x1000x330				
13.775	Brochure Holder Size: A5				
10.473	Brochure Holder Size: A4				

## SAGRES LECTERN



# LITERATURE STAND Literature Stands

## STAND DETAILS



## DIMENSIONS

\* W: Width H: Height D: Depth \* mm

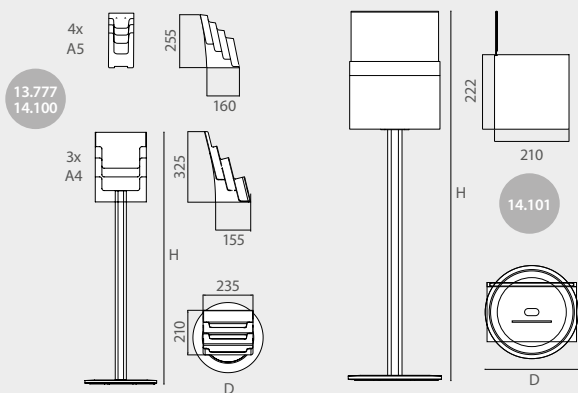

## INFORMATION

\* W: Width H: Height D: Depth \* mm

This Holder Stand features 2 model design: The Brochure Holder has 2 dispenser sizes available: A4 (3 pockets) or A5 format (4 pockets) for displaying documents like brochures, flyers, or catalogues. The BallotBox model is designed for gathering customer feedback, complaints, ideas or contests. Both models has a solid 5kg base with 2 decorative interchangeable extra covers (included). The acrylic brochure holder arrives in a separate box from the base and pole stand. These floorstanding leaflet dispenser are also ideal for special promotions at various events, like tradeshows, hotels information, restaurants, retailers, corporate events or places with a high traffic area.

## LEAFLET STAND

\* W: Width H: Height D: Depth \*mm

	QTY	N.W	G.W	C.B.M	Size (WxHxD)	
Packing	1	5kg	5.3kg	0.0055	350x35x45	x3
	1	0.70kg	0.85kg	0.0035	895x65x37	
	1	1.1kg	1.5kg	0.0194	330x230x260	
External (HxD)						
Product	1170xØ330					
13.777	Leaflet Dispenser Size: A5					
14.100	Leaflet Dispenser Size: A4					

## BALLOT BOX

\* W: Width H: Height D: Depth \*mm

	QTY	N.W	G.W	C.B.M	Size (WxHxD)	
Packing	1	5kg	5.3kg	0.0055	350x350x45	x3
	1	0.70kg	0.85kg	0.0035	895x65x37	
	1	1.7kg	2.4kg	0.0332	380x265x330	
External (HxD)						
Product	1323xØ330					
14.101						

## BROCHURE & BALLOTBOX FREESTAND



## DISPLAY DETAILS

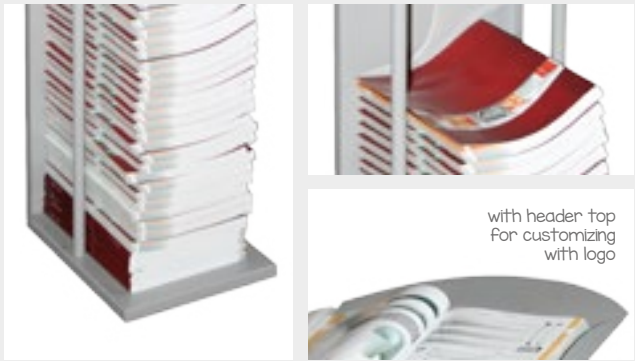

## INFORMATION

\*mm

Bari features a strong and stable design and it is made of steel with a silver finish to easily match any environment. Featuring a top holder for 2xA4 max. wide documents. Perfect for displaying in an orderly manner with an open-front design for customers. Bari is ideal for displaying travel magazines, real estate booklets, autos-for-sale publications, catalogues and other types of literature.

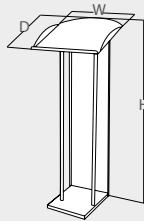

## BARI

\* W: Width H: Height D: Depth \*mm

	QTY	N.W	G.W	C.B.M	Size (WxHxD)
Packing	1	8.6kg	11kg	0.3125	500x1250x500
		External (WxHxD)			
Product	455x1210x450				
10.219					

## BARI

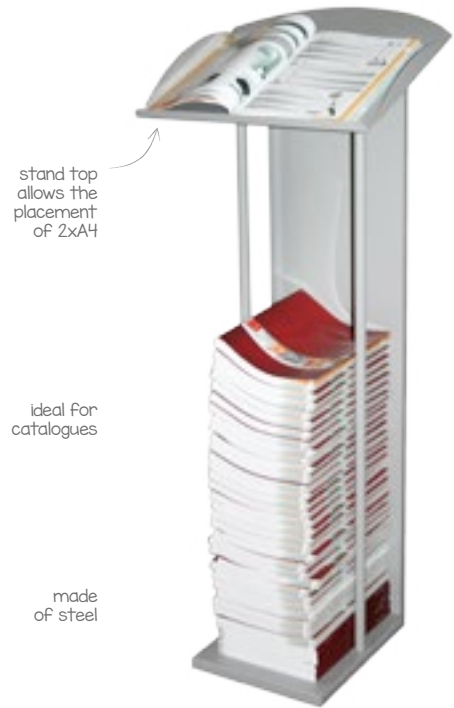

## DISPLAY DETAILS



## INFORMATION

\*mm

Vegas Brochure Stand offers the look and stability of a permanent fixture and the versatility of a portable stand. Featuring 4x4A4 format pockets. This foldable silver tradeshow literature rack can be stored with pamphlets and magazines in the pockets, even when the unit is collapsed and stowed away. Set up is simple, just taking the unit out of the carrying bag and pulling the pockets upward. Ideal for conventions, tradeshow, exhibitions, media events or places with a high traffic area.



## VEGAS

\* W: Width H: Height D: Depth \*mm

	QTY	N.W	G.W	C.B.M	Size (WxHxD)
Packing	1	6kg	8kg	0.067	380x470x380
		External (WxHxD)			
Product	280x1605x260				
10.048					

## VEGAS





## STAND DETAILS



## INFORMATION

\*mm

Soubran is designed to be mobile and compact. In this model it features 5 portrait steel pockets for A4 portrait format documents. This tradeshow literature rack can be stored with magazines in the pockets, even when the unit is folded and stowed away. With a front bottom space to place a graphic and a carry-bag. Ideal for trade shows, conventions, exhibitions, retail outlets or showroom floors to attract customers looking for additional information.

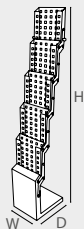

## SouBRAN

\* W: Width H: Height D: Depth

\*mm

	QTY	N.W	G.W	C.B.M	Size (WxHxD)
Packing	1	8kg	10kg	0.148	550x770x350
		External (WxHxD)			
Product	230x1420x290				
10.416					

## SOUBRAN

5x A4 portrait steel shelves

steel structure

the bottom can be used to place a graphic



## STAND DETAILS

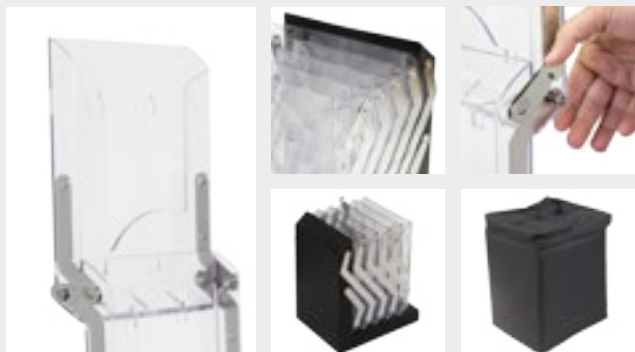

## INFORMATION

\*mm

Colmenar is designed to be mobile and compact. In this model it features 5 portrait acrylic pockets for A4 portrait format documents. This tradeshow literature rack can be stored with magazines in the pockets, even when the unit is folded and stowed away. With a front bottom space for graphic and a nylon carry-bag. Ideal for trade shows, conventions, exhibitions, retail outlets or showroom floors to attract customers looking for additional information.

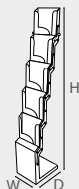

## COLMENAR

\* W: Width H: Height D: Depth

\*mm

	QTY	N.W	G.W	C.B.M	Size (WxHxD)
Packing	1	5kg	7kg	0.148	550x770x350
		External (WxHxD)			
Product	230x1420x290				
13.718					

## COLMENAR

5x A4 portrait acrylic shelves

steel structure

the bottom can be used to place a graphic





## STAND DETAILS



nylon bag  
option 13.717

briefcase  
option 10.047

## DIMENSIONS

\* W: Width H: Height D: Depth \* mm

option 1  
Nylon Bag  
13.717

option 2  
Briefcase  
10.047

13.717

10.047

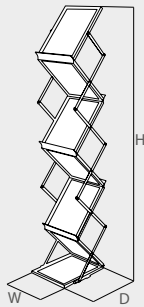

## INFORMATION

Sahagun is designed to be mobile and compact. It has a zigzag design that folds down into a small unit. Featuring 5x4 format literature holders for displaying. The literature holders provide a multi-level display system with an unobstructed view of magazines, brochures or any other periodicals you wish to display, also it is very lightweight thanks to its aluminium structure and acrylic holders. This brochure stand folds up into a small, lightweight unit. For a simple transportation you can choose between the nylon carry-bag or the deluxe briefcase option, which has reinforced foam padding. Use this portable literature stand as a single or double sided display at trade shows, retail outlets, or showroom floors to attract customers looking for additional information.

## SAHAGUN

\* W: Width H: Height D: Depth \*mm

	QTY	N.W	G.W	C.B.M	Size (WxHxD)
Packing	1	7.35kg	7.95kg	0.0293	360x480x170
	External (WxHxD)				
Product	260x1490x350				
13.717	Nylon Travel Bag				
10.047	Briefcase				

## SAHAGUN

5x4 portrait shelves

stable base by secure system



## STAND DETAILS

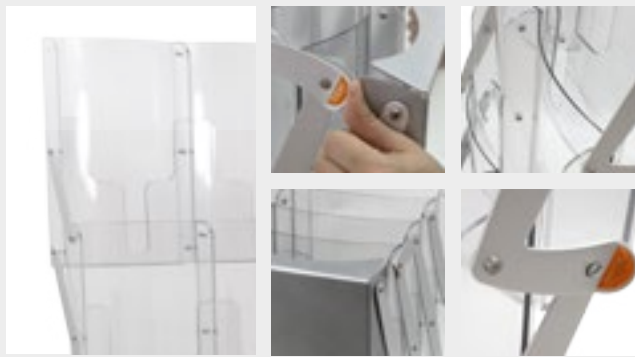

## INFORMATION

\*mm

The combination of contemporary design, durability and portability make Legnica one of the best options for literature displaying. With front bottom for graphics and 8 pockets for A4 portrait documents. Its design allows you to leave literature inside the pockets when the unit is folded. Ideal for travel magazines, real estate booklets, autos-for-sale publications, bussiness catalogues and also great for libraries, schools, hospitals, tradeshows or showroom floors.

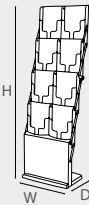

## LEGNICA

\* W: Width H: Height D: Depth

\*mm

	QTY	N.W	G.W	C.B.M	Size (WxHxD)
Packing	1	14.4kg	15.5kg	0.109	355x570x540
		External (WxHxD)			
Product	480x1560x300				
10.114					

## LEGNICA

8x A4 portrait pockets



includes carry-bag



## STAND DETAILS

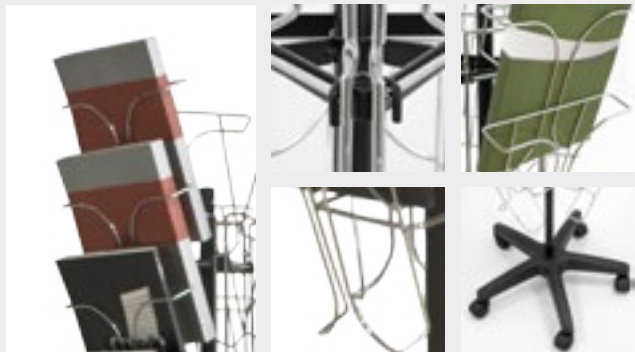

## INFORMATION

\*mm

The Nelas Brochure Stand is made of light weight and durable wire and it is designed for an easy rotation and quick selection of literature. With 21 pockets for displaying A4 portrait format documents. Featuring 5 swivel castors for an easy and comfortable transport. These displays are great for use at libraries, schools, offices, trade shows, exhibitions, travel agencies, waiting rooms, retail outlets or showroom floors.

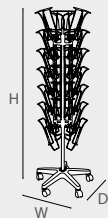

## NELAS

\* W: Width H: Height D: Depth

\*mm

	QTY	N.W	G.W	C.B.M	Size (WxHxD)
Packing	1	8kg	10.05kg	0.203	530x320x1200
		External (WxHxD)			
Product	510x1550x510				
13.101					

## NELAS

21x A4 portrait pockets

made of steel and plastic parts

easy rotation



## STAND DETAILS

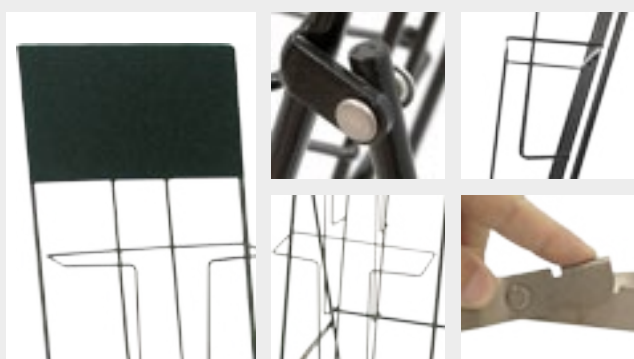

## INFORMATION

\*mm

Mentrida features a stable design with a black finish to easily match any environment. Featuring a top header and a front bottom area for graphics. It also organizes and displays your magazines in an orderly manner with an open-front design for customers. Mentrida Stand features 5 pockets for displaying A4 portrait format documents. Ideal for travel magazines, real estate booklets, autos-for-sale publications, bussiness catalogues and also great for use at libraries, schools, hospitals or doctors' offices.



## MENTRIDA

\* W: Width H: Height D: Depth \*mm

	QTY	N.W	G.W	C.B.M	Size (WxHxD)
Packing	1	4.2kg	5.1kg	0.0565	120x1520x310
		External (WxHxD)			
Product	250x1465x470				
10.720					

## MENTRIDA

5x A4 portrait pockets

made in black painted steel

the bottom can be used to place a graphic



## STAND DETAILS



## INFORMATION

\*mm

Bañeza features a stable design with a black finish to easily match any environment. Featuring a top header and front bottom areas for graphics. Featuring 7 pockets for displaying A4 portrait format documents. Bañeza is ideal for travel magazines, real estate booklets, autos-for-sale publications, bussiness catalogues and also great for use at libraries, schools, hospitals or doctors' offices.



## BAÑEZA

\* W: Width H: Height D: Depth \*mm

	QTY	N.W	G.W	C.B.M	Size (WxHxD)
Packing	1	2.9kg	3.6kg	0.0532	100x1420x375
		External (WxHxD)			
Product	280x1370x370				
10.044					

## BAÑEZA

7x A4 portrait pockets

made in black painted steel

the bottom can be used to place a graphic



## STAND DETAILS

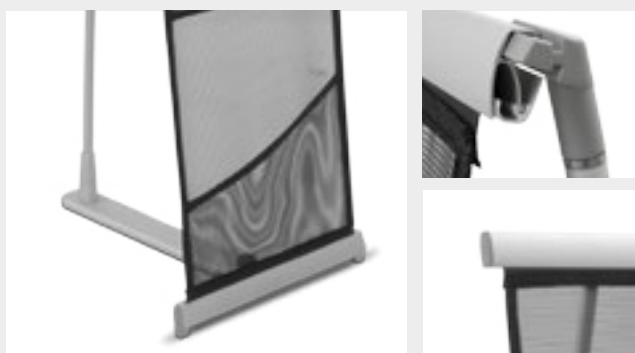

## INFORMATION

Sil Brochure Stand is perfect for exhibitors who need a lightweight and portable display for their tradeshow booth. This magazine stand is made of black mesh and has 4 pockets for A4 Portrait format documents. Featuring an elastic design to the pockets that keeps reading materials secure and erect while on display. Includes carrying-bag.

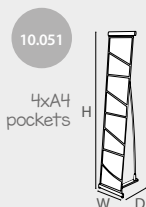

## SIL SIMPLE

\* W: Width H: Height D: Depth \*mm

	QTY	N.W	G.W	C.B.M	Size (WxHxD)
Packing	1	1.05kg	1.20kg	0.0086	120x600x120
	External (WxHxD)				
Product	270x1360x380				
10.051	4 x A4 Pockets				

## SIL

4x A4 pockets

made of nylon and aluminium

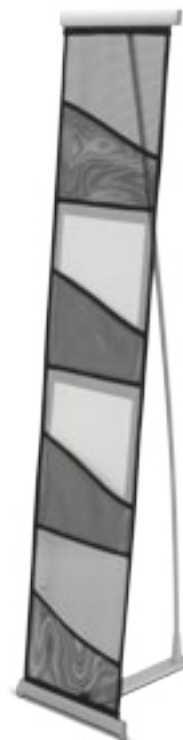

## STAND DETAILS

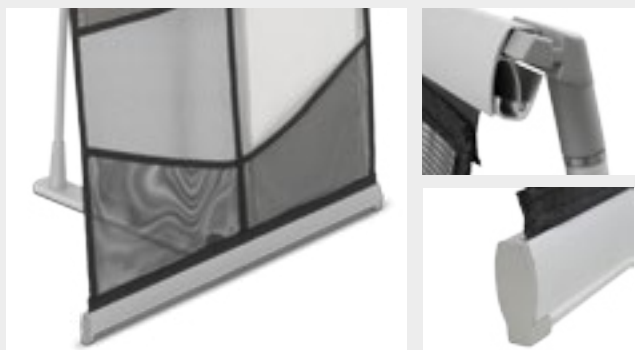

## INFORMATION

Sil Double Brochure Stand is perfect for exhibitors who need a lightweight and portable display for their tradeshow booth. This magazine stand is made of black mesh and has 8 pockets for A4 Portrait format documents. Featuring an elastic design to the pockets that keeps reading materials secure and erect while on display. Includes carrying-bag.

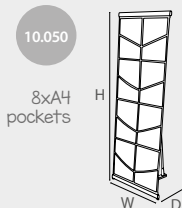

## SIL DOUBLE

\* W: Width H: Height D: Depth \*mm

	QTY	N.W	G.W	C.B.M	Size (WxHxD)
Packing	1	1.4kg	1.55kg	0.0086	120x600x120
	External (WxHxD)				
Product	545x1360x380				
10.050	8 x A4 Pockets				

## SIL DOUBLE

8x A4 pockets

made of nylon and aluminium

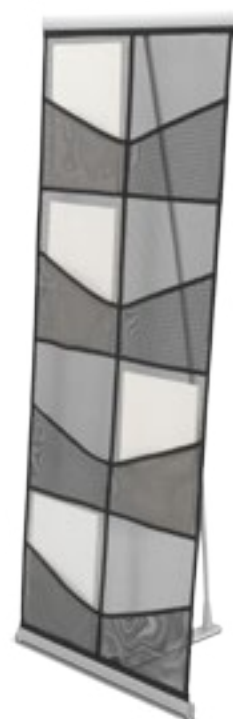

## HOLDER DETAILS



## DIMENSIONS

\* mm

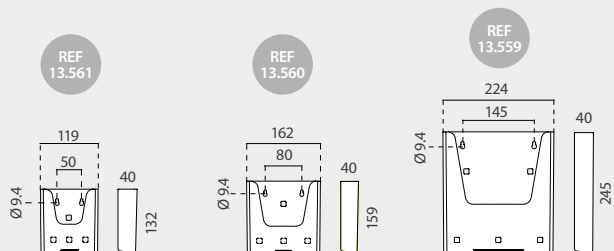

## ACCESSORIES COMBINATIONS (NEXT PAGE)

REF 12.171



REF 13.499



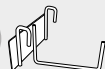

REF 13.406



## INFORMATION

This acrylic Brochure Holder features 3 sizes: A6, A5 or A4 formats. Built with pre-drilled holes, suitable for being used with suction cups, base feet or for wall mounting with proper accessories (see next page). Rounded pocket fronts give this display a stylish appearance and its acrylic is optically clear.

DISPENSER COMPARTMENTS COMPARTMENT SIZE

DISPENSER	COMPARTMENTS	COMPARTMENT SIZE	
13.561	1	A6	x10 
13.560	1	A5	x10 
13.559	1	A4	x10 

## SINGLE BROCHURE HOLDER



REF 13.499

## HANGER DETAILS



## INFORMATION

\*mm

Acrylic Brochure Holder for A6 leaflet size. Double magnet fixing system. No tools required. Ideal for any Roll Up.



MAGNET DISPENSER	QTY	N.W.	G.W.	C.B.M.	SIZE
Packing	5	0.85kg	0.95kg	0.004	165x130x215mm 
10.860	Graphic Size: A6		x5 		

## MAGNETIC BROCHURE HOLDER



## BASE FEET DETAILS

## DIMENSIONS

\* mm



## INFORMATION

Base feet made of acrylic with transparent appearance, they are designed for being used with brochure holders. Possibility of using one or two bases according to holder model. Ideal for making a desktop use. Sold in packs of 20 units.

BASE FEET	SIZE	
13.499	45x17x89mm	x20 

## BASE FEET FOR BROCHURE HOLDER



## SUCTION CUPS DETAILS

## DIMENSIONS

\* mm

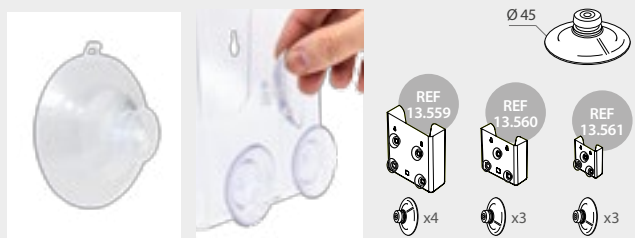

## INFORMATION

These Suction Cups give a reinforced adhesion to your brochure holders thanks to their double suction. Possibility of using 3 or 4 suction cups according to holder model. Ideal for making a wall mounted use. Sold in packs of 100 units.

SUCTION CUPS	DIAMETER	
12.171	Ø45mm	x100 

## DOUBLE SUCTION CUP FOR BROCHURE HOLDER



## HANGER DETAILS



## INFORMATION

## DIMENSIONS

\* mm

This Hanger is made of metal and it has 3 hooks. It is suitable for being used with leaflet dispensers on shelves. Sold in packs of 10 units.

HANGER	SIZE	
13.406	80x30x70mm	x10 

## SHELF HANGER FOR BROCHURE HOLDER



\* Wall holders at this page are available but not included.

## HOLDER DETAILS



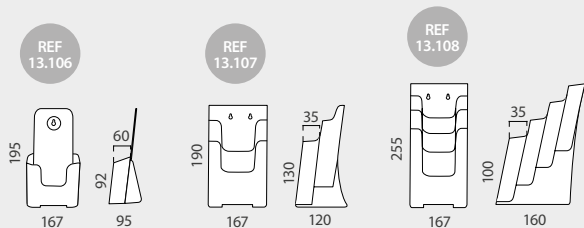

## DIMENSIONS

\* mm



## INFORMATION

This Brochure Holder features an A5 format size and 3 models, depending of its compartments. These literature holders, also known as leaflet displays, pamphlet dispensers, are ideal for distributing your free promotional literature. Built with pre-drilled holes, this literature rack can be wall mounted to ensure that customers will be able to see your promotional material while they browse your gift shop or wait in your lobby. Also, the compact design of this display helps keep your table tops and counters neat and organized. Rounded pocket fronts give this economy display a slightly stylish appearance and its acrylic is optically clear.

1x A5	COMPARTMENTS	COMPARTMENT SIZE		
13.106	1	A5	x4	
2x A5	COMPARTMENTS	COMPARTMENT SIZE		
13.107	2	A5	x4	
4x A5	COMPARTMENTS	COMPARTMENT SIZE		
13.108	4	A5	x2	

## TRANSPARENT A5 BROCHURE HOLDER





## HOLDER DETAILS



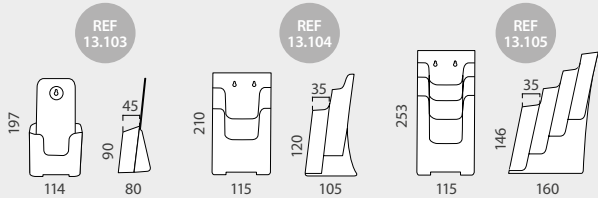

## DIMENSIONS

\* mm



## INFORMATION

This Brochure Holder features a 1/3 of A4 format size and 3 models, depending of its compartments. Built with pre-drilled holes, this literature rack can be wall mounted. Compact design and rounded pocket fronts give this economy display a stylish appearance and its acrylic is optically clear.

1x 1/3 A4	COMPARTMENTS	COMPARTMENT SIZE		
13.103	1	1/3 A4	x6	
2x 1/3 A4	COMPARTMENTS	COMPARTMENT SIZE		
13.104	2	1/3 A4	x4	
4x 1/3 A4	COMPARTMENTS	COMPARTMENT SIZE		
13.105	4	1/3 A4	x2	

## TRANSPARENT 1/3 A4 BROCHURE HOLDER



## HOLDER DETAILS



## INFORMATION

This Brochure Holder features a double 1/3 of A4 format. Rounded pocket fronts give this economy display a stylish appearance and its acrylic is optically clear.

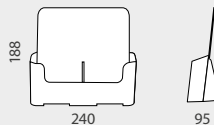

DOUBLE 1/3 A4	COMPARTMENTS	COMPARTMENT SIZE		
13.834	2	1/3 A4	x4	

## TRANSPARENT DOUBLE 1/3 A4 BROCHURE HOLDER

**NEW**



## HOLDER DETAILS



## DIMENSIONS

\* mm

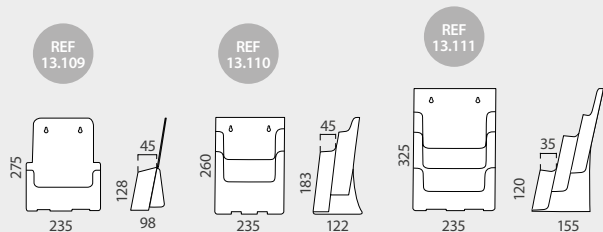

## INFORMATION

This Brochure Holder features an A4 format size and 3 models, depending of its compartments. These literature holders, also known as leaflet displays, pamphlet dispensers, are ideal for distributing your free promotional literature. Built with pre-drilled holes, this literature rack can be wall mounted to ensure that customers will be able to see your promotional material while they browse your gift shop or wait in your lobby. Also, the compact design of this display helps keep your table tops and counters neat and organized. Rounded pocket fronts give this economy display a slightly stylish appearance and its acrylic is optically clear.

1x A4	COMPARTMENTS	COMPARTMENT SIZE		
13.109	1	A4	x4	

2x A4	COMPARTMENTS	COMPARTMENT SIZE		
13.110	2	A4	x2	

3x A4	COMPARTMENTS	COMPARTMENT SIZE		
13.111	3	A4	x2	

## TRANSPARENT A4 BROCHURE HOLDER



## HOLDER DETAILS

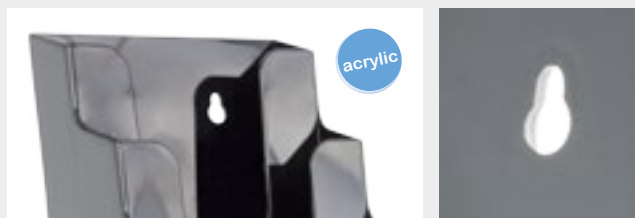

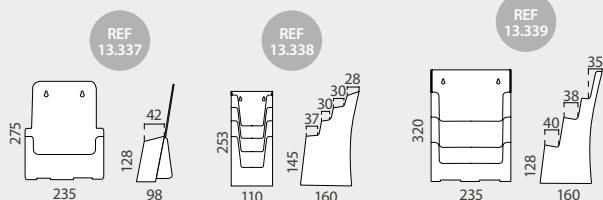

## DIMENSIONS

\*mm



## INFORMATION

These three models of dispensers are made of black colored plastic. Suitable for use them over countertops or mounted on walls. Ideal for being used at retail stores, real estates, offices, hospitals or academies

BLACK	COMPARTMENTS	COMPARTMENT SIZE	
13.337	1	A4	x4 
13.338	4	1/3 A4	x2 
13.339	3	A4	x2 

## BLACK BROCHURE HOLDER

countertop or wall  
mount unit



## HOLDER DETAILS

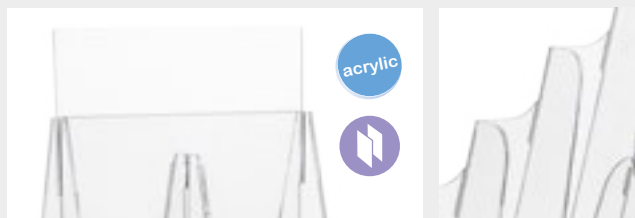

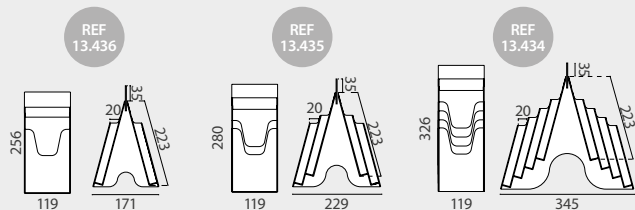

## DIMENSIONS

\*mm



## INFORMATION

These three models of double-sided dispensers are made of transparent plastic. Suitable for use them over countertops. Ideal for being used at retail stores, real estates, offices, hospitals or academies

2-SIDED	COMPARTMENTS	COMPARTMENT SIZE	
13.436	1x2	1/3 A4	x4 
13.435	2x2	1/3 A4	x2 
13.434	4x2	1/3 A4	x2 

## 2-SIDED 1/3 A4 BROCHURE HOLDER

top advert  
insert\* included

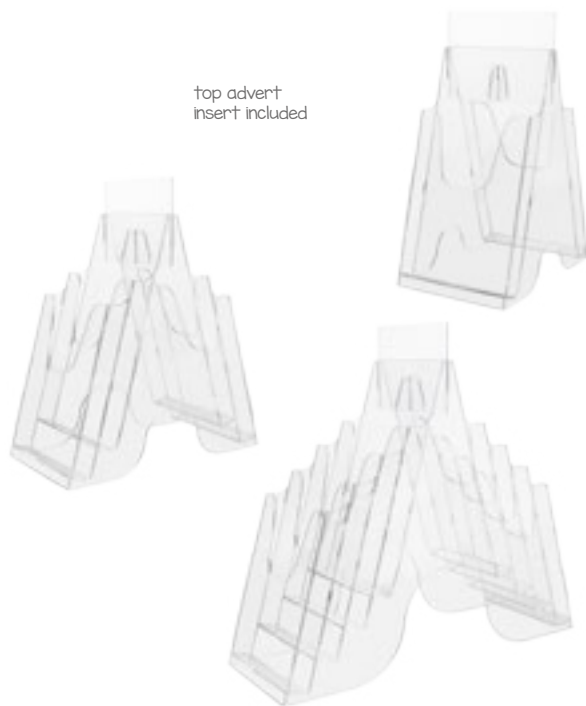



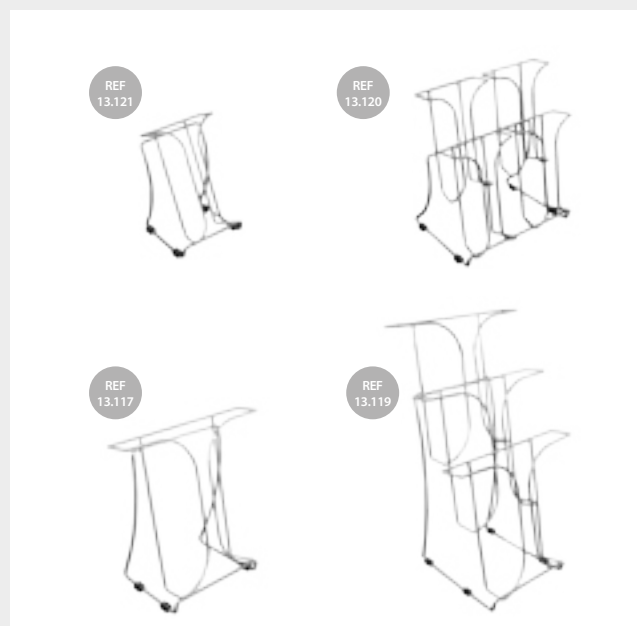

## HOLDER DETAILS



## INFORMATION

Desktop leaflet dispensers made of chromed wire. Suitable for A4 or 1/3 A4 documents. There are 4 models available. Features rubber feet to protect countertop surface. Ideal for being used at retail stores, offices or hospitals.

WIRE 1/3 A4	QTY	N.W	G.W	C.B.M	SIZE
Packing	1	0.25kg	0.45kg	0.004	135x140x220 mm
<b>13.121</b>	<b>Graphic Size: 1/3 A4</b>				<b>x1</b> 
WIRE 4A	QTY	N.W	G.W	C.B.M	SIZE
Packing	1	0.35kg	0.55kg	0.01	270x150x270 mm
<b>13.117</b>	<b>Graphic Size: 1x A4</b>				<b>x1</b> 
WIRE 4x 1/3 A4	QTY	N.W	G.W	C.B.M	SIZE
Packing	1	0.6kg	0.8kg	0.015	270x200x295 mm
<b>13.120</b>	<b>Graphic Size: 4x 1/3 A4</b>				<b>x1</b> 
WIRE 3xA4	QTY	N.W	G.W	C.B.M	SIZE
Packing	1	0.7kg	0.9kg	0.029	270x230x470 mm
<b>13.119</b>	<b>Graphic Size: 3x A4</b>				<b>x1</b> 

## WIRE BROCHURE HOLDER



with rubber feet to protect countertop surface



## HOLDER DETAILS

## INFORMATION

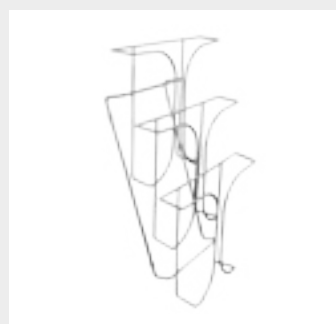

Wall leaflet dispensers made of chromed wire. Suitable for three A4 documents. Ideal for being used at retail stores, offices or hospitals.

WALL WIRE 3xA4	QTY	N.W	G.W	C.B.M	SIZE
Packing	1	0.65kg	0.85kg	0.027	270x230x450 mm
<b>13.118</b>	<b>Graphic Size: 3x A4</b>				<b>x1</b> 

## WALL WIRE BROCHURE HOLDER

wall unit









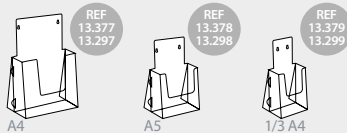

## HOLDER DETAILS



## INFORMATION

These Dispensers are made of white or transparent PVC. Suitable for A4, A5 and 1/3 A4 format documents. Ideal for being used on desktops.



L. CLEAR	COLOR	SIZE	THICKNESS		
13.377		A4	0.7mm	x10	
13.378		A5	0.7mm	x10	
13.379		1/3 A4	0.7mm	x10	
L. WHITE	COLOR	SIZE	THICKNESS		
13.297		A4	0.7mm	x10	
13.298		A5	0.7mm	x10	
13.299		1/3 A4	0.7mm	x10	

## PVC BROCHURE HOLDER



## HOLDER DETAILS

## INFORMATION

\*mm



This brochure holder is made of 0.6mm thickness PVC and is suitable for A6 size documents (or for 105mm maximum width documents). It is ideal for desktops.



105x141 A6	DOCUMENT	SIZE	THICKNESS		
13.063	A6	105x141mm	0.6mm	x30	

## A6 PVC BROCHURE HOLDER



## HOLDER DETAILS

## INFORMATION

\*mm



Brochure pocket is made of 0.4mm thickness PVC. It is suitable for coupons, calendars or documents with 98mm maximum width. It is ideal for desktops.

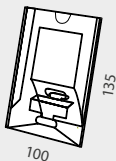

PVC POCKET	SIZE	THICKNESS		
13.432	100x135mm	0.4mm	x30	

## POCKET PVC BROCHURE HOLDER



**HOLDER DETAILS**



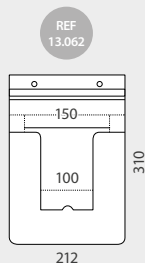
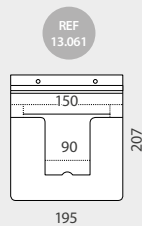
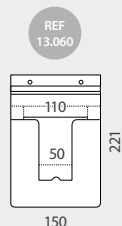

**DIMENSIONS**

\*mm



**INFORMATION**

This dispensers are made of 0.5mm thickness PVC. Suitable for A5 or A6 documents (from 110 to 150mm maximum width documents). They are excellent for fixing on shelf edges thank to its top adhesive strip.

DISPENSER	DOCUMENT	SIZE	THICKNESS	
13.060	A6	150x221mm	0.5mm	x30 
13.061	A5-A6	195x207mm	0.5mm	x30 
13.062	A5	212x310mm	0.5mm	x30 

**SHELF PVC  
BROCHURE HOLDER**



**HOLDER DETAILS**

**INFORMATION**

\*mm

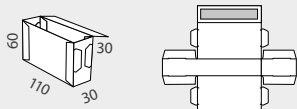

This dispenser, made of PVC with adhesive strip, is excellent for holding business cards or promotional coupons. Container external size: 110x60x30mm.

DISPENSER	SIZE	THICKNESS	
13.431	110x60x30mm	0.4mm	x30 

**COUPON CARD  
BROCHURE HOLDER**



## HOLDER DETAILS

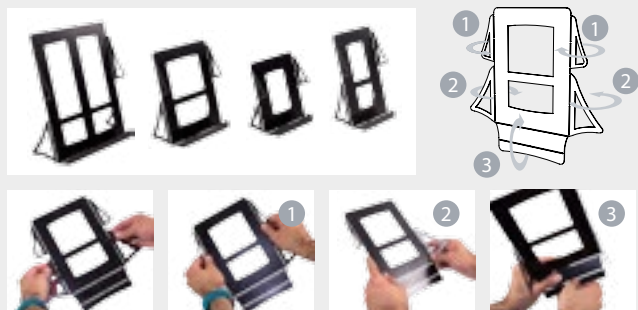

## EXTERNAL AND FORMAT SIZES

\*mm

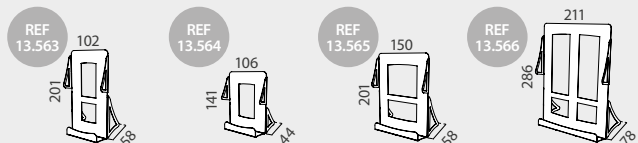

## INFORMATION

Black Leaflet Holder made of metal and supplied flat for optimum storage. Featuring 4 sizes (1/3 A4, A6, A5 and A4 format). Quick and simple assembly, in only three steps and folding it with your hands is completely assembled.

METAL H. 1/3 A4	QTY	N.W	G.W	C.B.M	SIZE
Packing	1	0.78kg	0.88kg	0.0009	260x255x16 mm
13.563		Graphic Size: 1/3 A4		x4	
METAL H. A6	QTY	N.W	G.W	C.B.M	SIZE
Packing	1	0.6kg	0.65kg	0.0006	203x195x16 mm
13.564		Graphic Size: A6		x4	
METAL H. A5	QTY	N.W	G.W	C.B.M	SIZE
Packing	1	0.96kg	1.08kg	0.0011	276x255x16 mm
13.565		Graphic Size: A5		x4	
METAL H. A4	QTY	N.W	G.W	C.B.M	SIZE
Packing	1	1.59kg	1.79kg	0.002	375x340x16 mm
13.566		Graphic Size: A4		x4	

## HAND FOLDED METAL HOLDER



## STAND DETAILS



## INFORMATION

\*mm

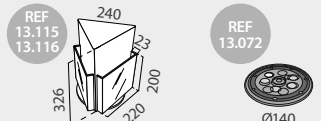

This acrylic Rotating Stand is suitable for placing A4 format documents. Offered in black or white color. Also, available the Turntable Display (ref. 13.072).



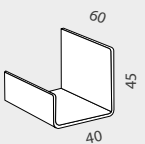

ROTATORY	COLOR	SIZE	
13.115		A4	x1
13.116		A4	x1
TURNTABLE	SIZE		
13.072	Ø140mm	x2	

## ROTATORY BROCHURE STAND



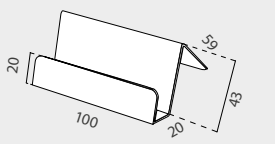

HOLDER DETAIL	INFORMATION	DIMENSIONS *mm
	<p>This transparent Business Card Holder is made of 2mm thickness acrylic. It is ideal for displaying ID cards, directory signage, temporary notes... It is an excellent addition to any desktop. Featuring 3 models available.</p>	
A.HOLDER	SIZE	THICKNESS
50.321	60x45x40mm	2mm
		x20 



HOLDER DETAIL	DIMENSIONS *mm	
		
INFORMATION		
<p>This grey Business Card Holder is made of 1mm thickness metal. It is ideal for displaying ID cards, directory signage, little notebooks or just for temporary notes... This Card Holder is an excellent addition to any desktop.</p>		
METAL HOLDER	SIZE	THICKNESS
13.413	100x43x20mm	1mm
		x10 

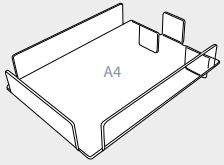

HOLDER DETAILS		
		
INFORMATION		
<p>This desktop acrylic document tray holder is suitable for A4 format documents. It is made of 4mm thickness acrylic.</p>		
		
D.D.HOLDER	SIZE	THICKNESS
13.405	A4	4mm
		x2 

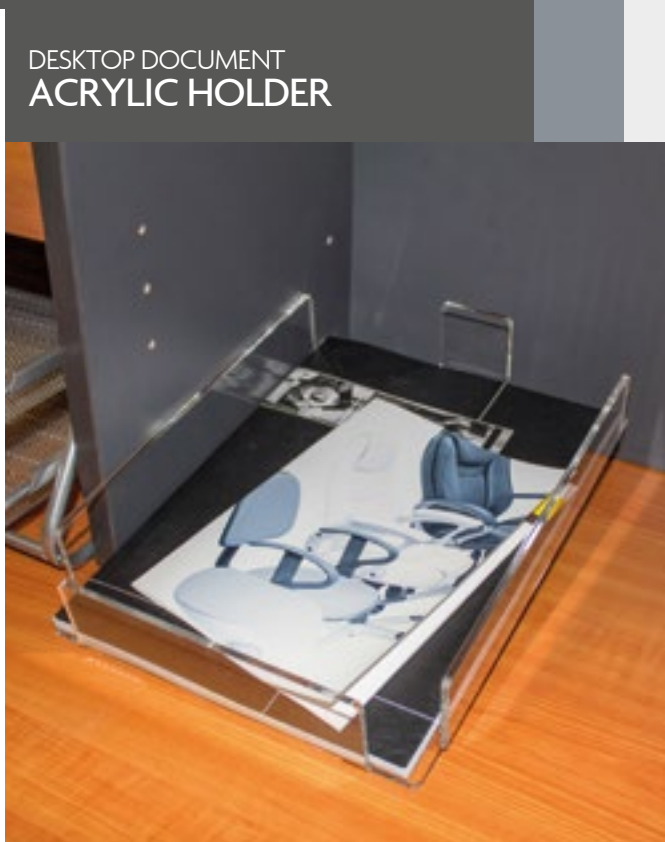



## HOLDER DETAIL



## POCKET LANDSCAPE WALL MOUNTED BUSINESS CARD HOLDER



## INFORMATION

## DIMENSIONS \*mm

This Transparent Card Holder is made of 2mm thickness acrylic and it suitable for wall mounting. Thanks to its 6 pockets it is ideal for placing near a reception desk, beside an information point or just next to the entry door, keeping countertops clean and cards highly visible. Each compartment holds approximately 80 cards.

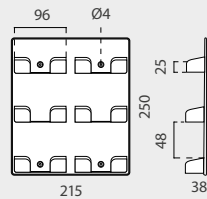

W.M.C.HOLDER	SIZE	THICKNESS	
13.439	250x38x215mm	2mm	x6 

## HOLDER DETAILS



## ACRYLIC POCKET WALL BROCHURE HOLDER



## INFORMATION

This acrylic Wall Dispenser with portrait orientation has 2 holes at the top for wall mounting. With A4 and A5 format available.

REF  
13.382

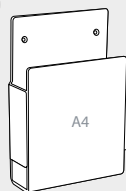

REF  
13.383

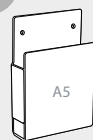

W.D.POCKET	SIZE	THICKNESS	
13.382	A4	4mm	x5 
13.383	A5	4mm	x5 

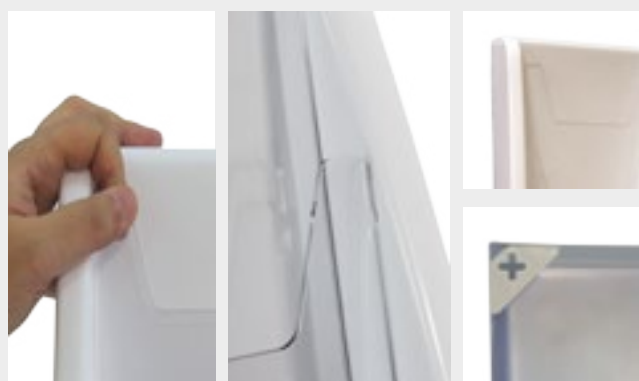

## HOLDER DETAILS

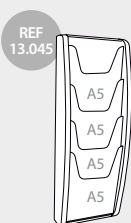
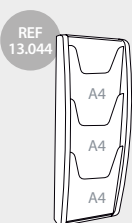

## INFORMATION

This wall mount dispenser with portrait orientation white pockets features 2 options: with 3 pockets for A4 size documents or with 4 pockets for A5 size documents. It is ideal for displaying literature documents like flyers, promotions, magazines placed at waiting rooms.



POLYSTYRENE	GRAPHIC SIZE		
13.044	3x 4A	x1	
13.045	4x A5	x1	

## WALL MOUNTED POLYSTYRENE DISPENSER



## HOLDER DETAILS



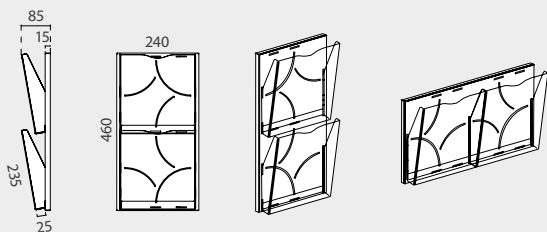

## EXTERNAL SIZE

\*mm



## INFORMATION

This decorative panel for A4 brochures or documents has 2 methacrylate dispensers. Featuring the possibility of installing bolted to the wall vertically or horizontally. It is produced in BLACK RAL 9005 and GREY RAL 9006. It includes 1 black or grey metallic panel, 2 acrylic pockets, screws and hangers.

MULTIPLEX	QTY	N.W	G.W	C.B.M	SIZE	
Packing	1	1.49kg	1.92kg	0.0129	485x265x100mm	
13.374		Pocket Size: A5			x1	

## MULTIPLEX WALL POCKET PANEL

black or grey color available



horizontal or vertical orientation available

## HOLDER DETAILS



## DIMENSIONS

\* mm

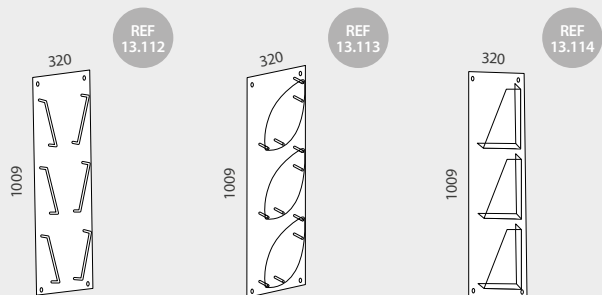

## INFORMATION

These Wall Mount Holders are made of plastic, featuring 3 pockets with portrait orientation for A4 size documents. There are available 3 different models according to the shape of their pockets ("line" shaped, "oval" shaped or "straight" shaped pockets). These displays are ideal for displaying literature A4 documents placed at waiting rooms.

A4 LINE

SIZE

13.112

320x1009mm

x1 

A4 OVAL

SIZE

13.113

320x1009mm

x1 

A4 FLASH

SIZE

13.114

320x1009mm

x1 

## WALL MOUNTED POLYSTYRENE HOLDER



## HOLDER DETAILS



### INFORMATION

\* mm

This wall leaflet dispenser features a transparent pocket with portrait orientation for A4 size documents. Our display is ideal for displaying literature documents such as flyers, promotions, magazines placed at waiting rooms or offices.

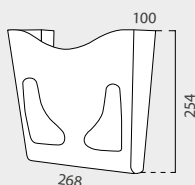

PORTRAIT W.P.	QTY	N.W	G.W	C.B.M	SIZE
Packing	1	0.32kg	0.52kg	0.008	270x270x115 mm
13.126	Size: A4 Portrait		x1 		

## WALL POCKET LEAFLET DISPENSER

### HOLDER DETAILS



### INFORMATION

\* mm

This wall leaflet dispenser features a transparent pocket with landscape orientation for A4 size documents. Our display is ideal for displaying literature documents such as flyers, promotions, magazines placed at waiting rooms or offices.

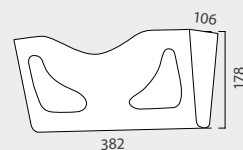

LANDSCAPE W.P.	QTY	N.W	G.W	C.B.M	SIZE
Packing	1	0.3kg	0.5kg	0.009	405x200x115 mm
13.127	Size: A4 Landscape		x1 		

## MAILBOX DETAILS



### INFORMATION

\* mm

This mailbox features a translucent body with portrait orientation and a black cover at the top. Our display is ideal for saving literature documents like flyers, promotions or suggestion forms placed at waiting rooms or offices.

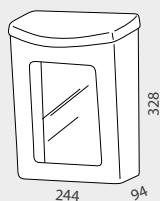

D. MAILBOX	QTY	N.W	G.W	C.B.M	SIZE
Packing	1	0.6kg	0.8kg	0.013	270x350x140 mm
13.125	Size: 244x328x94mm		x1 		

## DOCUMENT MAILBOX



## BALLOT BOX

214x214x213mm

### BALLOT BOX DETAILS



### INFORMATION

\*mm

This transparent ballot box is made of acrylic (Sides: 5mm thickness, Base, front and cap cover: 3mm thick and Top header: 1.5mm). It features a top landscape header which allows you to display graphic information and an easy change of graphics without having to open the unit. The old image is slid out the side through the openings. Clear entry boxes, acrylic ballot boxes are inexpensive marketing tools with a dual purpose. You can promote your business while creating an interactive display.

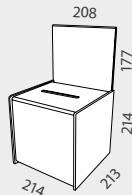

B. B.	214x214x213	QTY	N.W	G.W	C. B. M	SIZE
Packing	2	2.266kg	3.116kg	0.041	501x283x289 mm	
<b>13.567</b>	Graphic Size: 208x175mm		x2			

## BALLOT BOX

LOCKABLE 224x210x210mm

### BALLOT BOX DETAILS

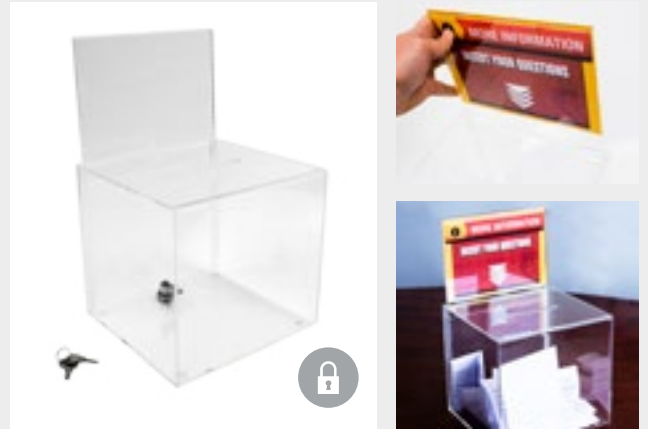

### INFORMATION

\*mm

This transparent ballot box is made of 3mm thickness acrylic. It features a top A5 landscape header which allows you to display graphic information and an easy change of graphics without having to unlock the unit. The old image is slid out the side through the openings. Also, this acrylic ballot box has a key lock to keep the contents secure and control access. Each unit is shipped with two keys.

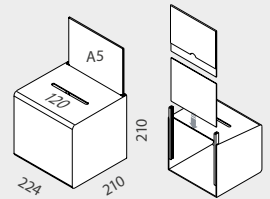

B. B.	224x210x210	GRAPHIC SIZE	THICKNESS
13.375	A5	3mm	x1

### BALLOT BOX DETAILS



### INFORMATION

\* mm

This transparent ballot box is made of acrylic. It features a 150x100mm top landscape header which allows you to display graphic information and an easy change of graphics without having to unlock the unit. The old image is slid out the side through the openings. Also, key lock is available to keep the contents secure and control access.

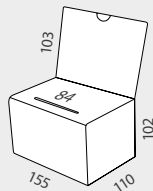

B. B.	150x110x102	QTY	N.W	G.W	C. B. M	SIZE
Packing	1	0.36kg	0.56kg	0.005	175x130x220 mm	
<b>13.099</b>	Graphic Size:150x100mm		x2			

B. B.	150x110x102 L	QTY	N.W	G.W	C. B. M	SIZE
Packing	1	0.32kg	0.52kg	0.005	175x130x220 mm	
<b>13.100</b>	Graphic Size:150x100mm		x2			

## BALLOT BOX

155x110x102mm



## BALLOT BOX DETAILS



REF 13.833

## INFORMATION

## DIMENSIONS

\*mm

This ballot boxes are made of 4mm thickness acrylic. Reference 13.833 features a frosted finish. References 13.568 and 13.569 transparent finish. Key lock is available to keep the contents secure and control access.

REF 13.833

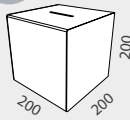

REF 13.568  
13.569

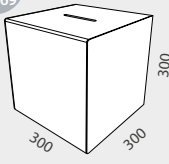

Frosted Ballot Box	QTY	N.W	G.W	C.B.M	SIZE
Packing	1	0.96kg	1.34kg	0.0165	255x250x260 mm
<b>13.833</b>		<b>Size:200x200x200mm</b>			<b>x1</b> 
Ballot Box 300	QTY	N.W	G.W	C.B.M	SIZE
Packing	1	1.88kg	2.738kg	0.0473	360x360x365 mm
<b>13.568</b>		<b>Size:300x300x300mm</b>			<b>x1</b> 
Lock Ballot Box 300	QTY	N.W	G.W	C.B.M	SIZE
Packing	1	1.9kg	2.762kg	0.0473	360x360x365 mm
<b>13.569</b>		<b>Size:300x300x300mm</b>			<b>x1</b> 

## SQUARE SIMPLE BALLOT BOX



REF 13.833

 Frosted Finish

REF 13.568

transparent Finish

REF 13.569



## BALLOT BOX DETAILS



## INFORMATION

\*mm

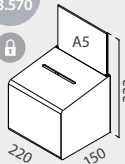

This Smoked ballot box is made of 3mm thickness acrylic. Features a top landscape header to display information. Easy change of graphics without having to unlock the unit through the side openings. Also, these acrylic ballot boxes have a key lock. Each unit is shipped with two keys.

REF 13.570

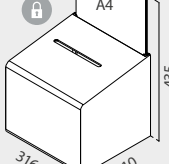

REF 13.571



A5 SMOKED	QTY	N.W	G.W	C.B.M	SIZE
Packing	2	1.89kg	2.42kg	0.0298	430x235x295 mm
<b>13.570</b>		<b>Graphic Size: A5 Landscape</b>			<b>x2</b> 
A4 SMOKED	QTY	N.W	G.W	C.B.M	SIZE
Packing	1	3.42kg	4.31kg	0.0587	510x295x390 mm
<b>13.571</b>		<b>Graphic Size: A4 Landscape</b>			<b>x1</b> 

## SMOKED ACRYLIC LOCKABLE BALLOT BOX





## BALLOT BOX DETAILS

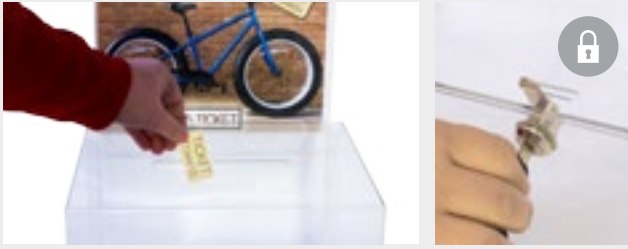

## INFORMATION

\* mm

This transparent ballot box is made of acrylic. It features a top A4 landscape header which allows you to display graphic information and an easy change of graphics without having to unlock the unit. The old image is slid out the side through the openings. Also, this acrylic ballot box has a key lock to keep the contents secure and control access. Each unit is shipped with two keys.

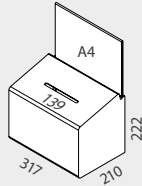

B.B.317x222x210	QTY	N.W	G.W	C.B.M	SIZE
Packing	1	1.7kg	1.9kg	0.022	290x240x330 mm
13.124	Graphic Size:297x210mm		x1 		

## BALLOT BOX LOCKABLE 317x222x210mm

Ideal for tradeshow, retail stores, malls or supermarkets



## BALLOT BOX DETAILS



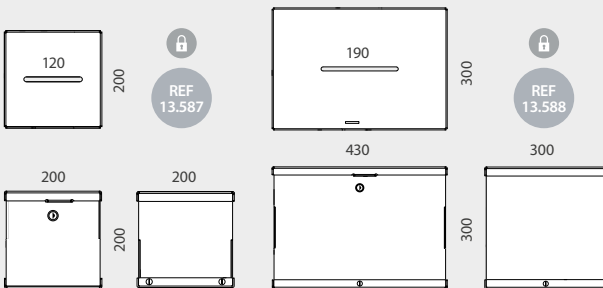

## DIMENSIONS

\* mm



## INFORMATION

This transparent ballot box is made of 4mm thick acrylic. This removable ballot box has a key lock to keep the contents secure and control access. It includes 4 sides, 2 caps, 4 screws, Key lock + 2 Keys. Once removed, all parts are overlapped for an optimum storage. Each unit is shipped with two keys and all the pieces for a correct assembly. Ideal for tradeshow, retail stores, malls or supermarkets.

REMOVABLE 1	QTY	N.W	G.W	C.B.M	SIZE
Packing	1	0.95kg	1.05kg	0.003	265x220x55 mm
13.587	Size: 200x200x200mm		x1 		
REMOVABLE 2	QTY	N.W	G.W	C.B.M	SIZE
Packing	1	2.6kg	2.8kg	0.0083	495x325x55 mm
13.588	Size: 430x300x300mm		x1 		

## REMOVABLE BALLOT BOX LOCKABLE 430x300x300mm

fully removable



## ACRYLIC DETAILS

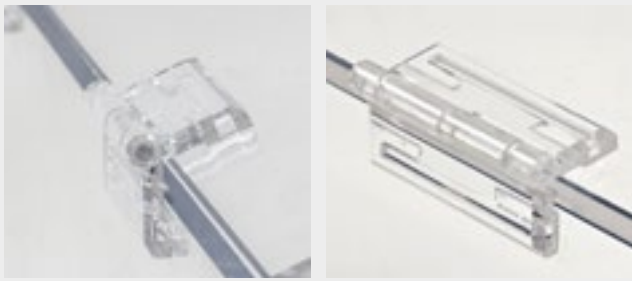

### INFORMATION

Acrylic Hinges with 6 available sizes. Ideal for creating acrylic boxes or ballot boxes.



### 200mm ACRYLIC HINGE

Size

10.943      200mm      x20 



### 65mm ACRYLIC HINGE

Size

10.945      65mm      x20 



### 30mm ACRYLIC HINGE

Size

10.947      30mm      x20 

## ACRYLIC HINGE

### ACRYLIC DETAILS



### 100mm ACRYLIC HINGE

Size

10.944      100mm      x20 



### 45mm ACRYLIC HINGE

Size

10.946      45mm      x20 



### 25mm ACRYLIC HINGE

Size

10.948      25mm      x20 

## 3 PIECES ACRYLIC LOCK

### ACRYLIC DETAILS

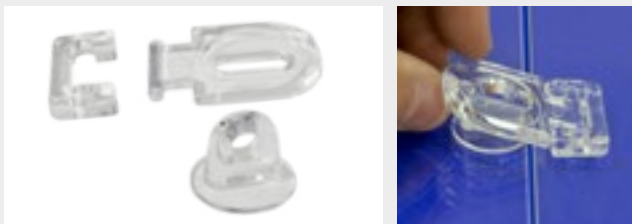

### INFORMATION

Acrylic Lock composed by 3 pieces. Ideal for creating acrylic boxes or ballot boxes.

A LOCK      Pieces

10.949      3 pieces      x20 

## ACRYLIC HANGER

### ACRYLIC DETAILS

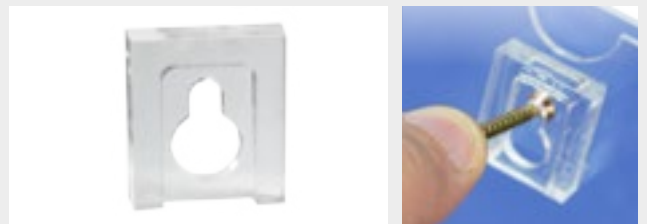

### INFORMATION

Acrylic Hanger. Ideal for holding acrylic stands, boxes or ballot boxes.

A HANGER      Size

10.950      22x25mm      x20 



# TEXTILE 07

Complete range of displays, wall holding systems for textile printing which provide an integral solution for the signage exhibition at selling point areas.

- 292** TEXTFIX
- 310** TEXTFIX ACCESSORIES
- 314** TENSION TEXTILE
- 337** PROMOTION COUNTERS
- 340** INDOOR FLAG BANNERS
- 342** HANGING SIGNS
- 345** ROTATING STAND



# TEXTIFIX



EN	Special profile system made of aluminium for textil. Profiles sizes are available in standard or linear meters. The textil should be sewn to a silicone "strip" around all its perimeter, then it is inserted into the rail of the profile being tight and perfectly framed.
FR	Profil spécial en aluminium pour textile. Les profils sont fournis en formats standard ou en barre. Facile et rapide à assembler. Le textile se coud sur une « bande de silicone », qui va s'introduire dans la rainure du profil ce qui permet un visuel parfaitement présenté, tendu et encadré.
PT	Perfil em alumínio para impressão em têxtil. Os perfis são fornecidos em medidas estandardizadas ou por metro linear. O tecido deve ser cosido a uma tira de silicone, que posteriormente será introduzida na ranhura do perfil de modo a ficar tenso e perfeitamente colocado.
ES	Sistema de perfilería de aluminio para tejidos. Los perfiles se suministran en medidas estándar o por metros lineales. El tejido es cosido a una "tira" de silicona en todo su perímetro, posteriormente para su fijación y tensado se introduce en el rail de la perfilería quedando perfectamente enmarcada.



## RANGE OF APPLICATIONS

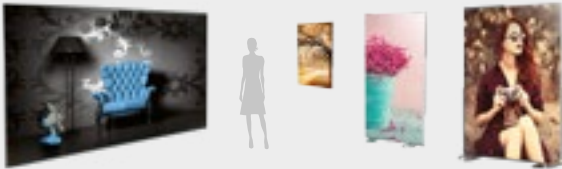

The Textifix Profile System is ideal for dressing and setting up shops, for showrooms, offices promotional booths, windows dressing or fair stands. Whether you want a wall frame, a backlite divider, a light totem, a standalone or hanging frame, you will find the right solution with our wide range of Textifix system. Among all Textifix options available are: Thin profiles, simple and double Ssided profiles, standard measurements or by linear meters, complete kit with lighting, blackened aluminum profiles, profiling designed for large surfaces and a complete series of accessories: hangers, bases, trays, connectors, etc...

## TEXTIL ARTWORK \*mm

- Place the hangers and fix them.
- Locate the corners connectors and join the aluminium profiles.
- Screw the corners and insert the silicone of the textil into the rail of the profile, get it total framed.

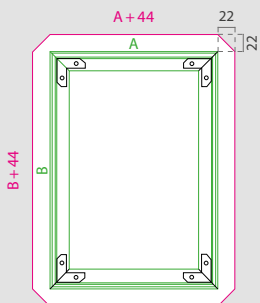

PROFILE SIZE TEXTIL TOTAL SIZE

## INSTALL EXPLANATION | TEXTIFIX



**INFORMATION**

- EN Other sizes available upon request.
- FR Disponible autres des tailles par demande.
- PT Outras medidas mediante consulta.
- ES Otras medidas disponibles bajo consulta.



**TEXTFIX LIGHT**  
ULTRA SLIM FRAME 15.5mm

15.5 mm  
thickness



**INFORMATION**

\*mm

- Featuring single-sided slim design of 15.5mm thickness.
- With LED system included. (lower power consumption)
- It's ideal for wall mounting at showrooms, expositions or windows/shop dressing.
- Other sizes of this profile are available upon a request.

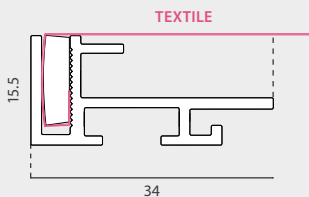

\*Printed on fabric.  
Impression sur toile.  
Impressão em tecido.  
Impresión en tela.

**STANDARD SIZES AVAILABLE**

ULTRA SLIM	GRAPHIC SIZE
13.180	A4
13.179	A3
13.178	A2
13.177	A1
13.176	A0
13.306	500x700mm
13.307	700x1000mm



TEXTIFIX CONTENT



EN Includes: 4 simple profiles, 4 corners and 1 Allen key type. Optional hangers available.

FR inclus: 4 profils simples, 4 équerres et 1 clef Allen. Crochets vendus séparément.

PT Inclui 4 perfis simples, 4 esquinas e 1 chave tipo Allen. Suspensão opcional.

ES Incluye 4 perfiles simples, 4 esquineros y 1 llave tipo Allen. Colgadores opcionales.

 \*Printed on fabric. Impression sur toile. Impressão em tecido. Impresión en tela.

INFORMATION

\*mm

- Set includes: 4 simple aluminum profiles, 4 corners and 1 Allen key.
- It's perfectly suitable for dressing and setting up shops, showrooms, offices and fair stands.
- Also displaying it as a promotional picture using hangers available next in TextFix accessories.

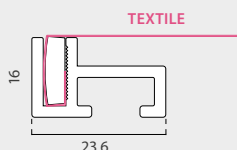

STANDARD SIZES AVAILABLE

16mm	GRAPHIC SIZE		
13.132	A4		
13.133	A3		
13.134	A2		
13.135	A1		T
13.136	500x700mm		T
13.137	700x1000mm		T
13.138	500x1000mm		T

TEXTIFIX 16mm



- optional hangers at TextFix accessories -



- T
- EN Fixing on the wall with screws in these sizes.
  - FR Fixer avec des vises pour toutes les tailles.
  - PT Fixar à parede seguindo as medidas indicadas.
  - ES Fijar con tornillos a la pared en estas medidas.

ALUMINIUM PROFILE BY LINEAR METERS

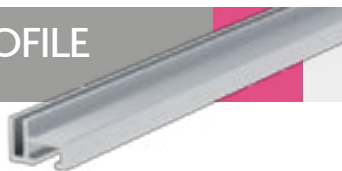

- EN Includes 4 units of 3m. Total 12m.
- FR Inclus 4 barres de 3 m. Total 12m.
- PT Inclui 4 perfis de 3m. Total: 12m.
- ES Incluye 4 perfiles de 3m. Total 12m.

PROFILE \*mm

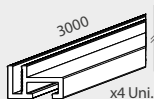

CORNER CONNECTORS



CONNECTOR \*mm

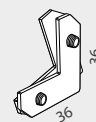

16mm   m	SIZE	
13.139	 4 Uni. x 3m/l=12m/l	

CORNER 16mm		
13.171	x20 	

## INFORMATION

EN Simple aluminum frame profile for textile digital printing. Ideal for being used on free spaces on walls. Easy and quick to assemble.

FR Profil simple en aluminium pour des impressions digitales en textile et de montage facile. Idéal pour combler des espaces vides.

PT Perfil simples de alumínio que permitem a colocação de impressões têxteis digitais. De fácil montagem. Ideal para cavidades nas paredes.

ES Perfil simple de aluminio ideal para la colocación en los huecos y espacios libres de las paredes. De montaje sencillo y rápido.



\*Printed on fabric.  
Impression sur toile.  
Impressão em tecido.  
Impresión en tela.

## TEXTIFIX WALL 27.5mm

Ideal For  
Free spaces  
on walls



## INFORMATION

\*mm

- This set includes: 4 Double-sided profiles, 4 corners and 1 Allen key.
- Thanks to its 27.5mm width profile is ideal for creating promotional frames at free spaces on the walls, dressing and setting up shops, fair stands, showrooms or offices.

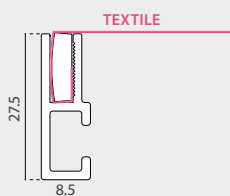

## ALUMINIUM PROFILE BY LINEAR METERS



- EN Includes 4 units of 3m. Total 12m.
- FR Inclus 4 barres de 3 m. Total 12m.
- PT Inclui 4 perfis de 3m. Total: 12m.
- ES Incluye 4 perfiles de 3m. Total 12m.

PROFILE \*mm

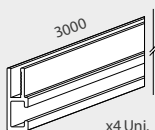

## CORNER CONNECTORS



CONNECTOR \*mm

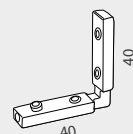

27.5mm | m SIZE

13.157  4 Uni. x 3m/|=12m/|

CORNER 40x40

13.243  x20

**TEXTIFIX CONTENT**



- EN Includes: 4 simple profiles, 4 corners and 1 Allen key type. Optional hangers available.
- FR inclus: 4 profils simples, 4 équerres et 1 clef Allen. Crochets vendus séparément.
- PT Inclui 4 perfis simples, 4 esquinas e 1 chave tipo Allen. Suspensão opcional.
- ES Incluye 4 perfiles simples, 4 esquineros y 1 llave tipo Allen. Colgadores opcionales.



\*Printed on fabric.  
Impression sur toile.  
Impressão em tecido.  
Impresión en tela.

**TEXTIFIX 2-SIDED 41.5x16mm**



**INFORMATION**

\*mm

- Set includes:  
4 simple aluminum profiles.  
4 corners and 1 Allen key.
- Thanks to its double-sided profile it is perfectly suitable for dressing and setting up shops, showrooms, offices and fair stands.

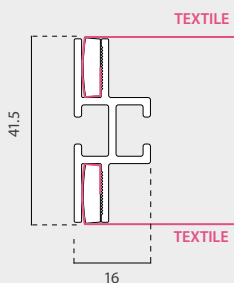

**STANDARD SIZES AVAILABLE**

41.5x16	GRAPHIC SIZE		
13.158	A4		
13.159	A3		
13.160	A2		
13.161	A1		

- optional hangers at Textifix accessories -



**ALUMINIUM PROFILE BY LINEAR METERS**



**PROFILE** \*mm

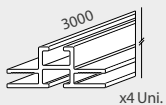

- EN Includes 4 units of 3m. Total 12m.
- FR Inclus 4 barres de 3 m. Total 12m.
- PT Inclui 4 perfis de 3m. Total: 12m.
- ES Incluye 4 perfiles de 3m. Total 12m.

41.5x16mm   m	QTY	N.W	G.W	C.B.M	SIZE
Packing	4	4.66kg	5.11kg	0.0147	75x65x3015mm
13.170					4 Uni. x 3m/l=12m/l

**CORNER CONNECTORS**



**CONNECTOR** \*mm

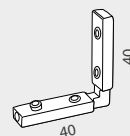

CORNER 40x40		
13.243	x20	

## TEXTIFIX CONTENT



EN Includes: 4 simple profiles, 4 corners and 1 Allen key type. Optional hangers available.

FR inclus: 4 profils simples, 4 équerres et 1 clef Allen. Crochets vendus séparément.

PT Inclui 4 perfis simples, 4 esquinas e 1 chave tipo Allen. Suspensão opcional.

ES Incluye 4 perfiles simples, 4 esquineros y 1 llave tipo Allen. Colgadores opcionales.



\*Printed on fabric.  
Impression sur toile.  
Impressão em tecido.  
Impresión en tela.

## TEXTIFIX 2-SIDED 41.3x38.1mm



## INFORMATION

\*mm

- This set includes: 4 Double-sided profiles, 4 corners and 1 Allen key.
- It's perfectly suitable for dressing and setting up shops, showrooms, offices and fair stands, displaying it as a totem using feet bases available next in TextFix accessories.

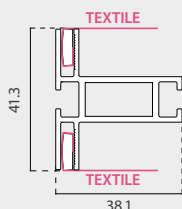

## STANDARD SIZES AVAILABLE

41.3x38.1	GRAPHIC SIZE
13.163	500x700mm
13.166	500x1000mm
13.164	700x1000mm
13.162	A0
13.167	1000x1000mm
13.165	1000x1400mm
13.168	1000x1500mm
13.282	700x2000mm
13.169	1000x2000mm

## ALUMINIUM PROFILE BY LINEAR METERS



EN Includes 4 units with 3m. Total 12m.

FR Inclus 4 barres de 3 m. Total 12m.

PT Inclui 4 perfis de 3m. Total: 12m.

ES Incluye 4 perfiles de 3m. Total 12m.

PROFILE \*mm

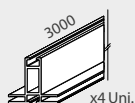

## CORNER CONNECTORS



CONNECTOR \*mm

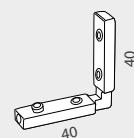

41.3x38.1mm   m	SIZE
13.058	 4 Uni. x 3m/ =12m/

CORNER 40x40	
13.243	x20 

\* the bases at this page are available but not included.

## TEXTFIX CONTENT

Ideal for textile use or rigid materials up to 3mm



\*Printed on fabric.  
Impression sur textile.  
Impressão em tecido.  
Impresión en tela.



**EN** Double-sided aluminum frame profile for textile printing. Black or aluminium finish. Includes: 2 Profiles, 4 corners and 1 Allen key type. Bases not included.

**FR** Profil double en aluminium pour des impressions en textile. Disponible en gris ou en noir. 2 profils, 4 équerres et 1 clef Allen inclus. Socles non inclus.

**PT** Perfil dupla face em alumínio para impressões têxteis. Disponível em preto ou cinzento. Inclui 2 perfis, 4 esquinas e 1 chave tipo Allen. Pés não incluídos.

**ES** Perfil doble para la elaboración de marcos de aluminio. Acabado en negro o aluminio. Incluye: 2 perfiles, 4 esquineros y 1 llave Allen. Bases no incluidas.

## TEXTILE TEXTFIX OPTION INFORMATION

\*mm

This TexFix frame features silver or black color and it is available in 3 sizes (2000, 3000 and 4000mm length). Also, each pack comes with 2 units. Aluprofit TexFix is an aluminium profile very used for dressing and setting up shops, showrooms, offices and fair stands or for using as a backlite totem display thanks its double sided option.

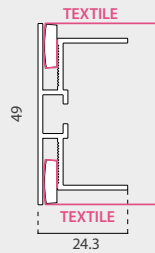

## RIGID MATERIAL OPTION INFORMATION

\*mm

Also, thanks its 4mm inner support, this TexFix aluminium profile features the possibility of being used with rigid materials up to 3mm. Bases and other optional accessories are available in TexFix accessories at this same chapter.

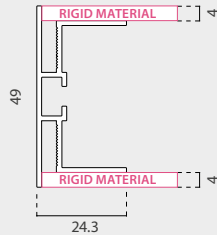

## ALUMINIUM PROFILE SIZES AVAILABLE

ALUPROFIT			SIZE
13.644			2 Uni. x 2000mm
13.645			2 Uni. x 3000mm
13.646			2 Uni. x 4000mm

## ALUPROFIT 49mm



double sided



simple set-up

CORNER 40x40

13.243 x20 

## CORNER CONNECTORS

CONNECTOR \*mm

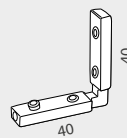

\* the bases at this page are available but not included.



TEXTIFIX CONTENT

with simple set-up



\*Printed on fabric.  
Impression sur toile.  
Impressão em tecido.  
Impresión en tela.

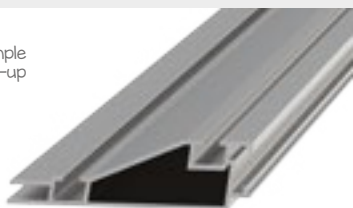

EN Includes: 4 simple profiles, 4 corners and 1 Allen key type.

FR inclus: 4 profils simples, 4 équerres et 1 clef Allen.

PT Inclui 4 perfis simples, 4 esquinas e 1 chave tipo Allen.

ES Incluye 4 perfiles simples, 4 esquineros y 1 llave tipo Allen.





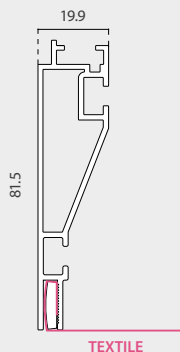

INFORMATION

\*mm

This TexFix frame features silver or black color and it is available in 3 sizes (2000, 3000 and 4000mm length). Also, each pack comes with 2 units. Aluprofit TexFix is an aluminium profile very used for dressing and setting up shops, showrooms, offices and fair stands or for using as a backlite totem display.



ALUMINIUM PROFILE SIZES AVAILABLE

WALL F. 81.5	SIZE	
13.647		 2 Uni. x 2000mm
13.648		 2 Uni. x 3000mm
13.649		 2 Uni. x 4000mm

CORNER CONNECTORS



CONNECTOR \*mm

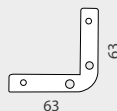

CORNER

13.333  x20

TEXTIFIX 81.5mm



CORNER CONNECTORS



CONNECTOR \*mm

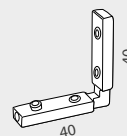

CORNER 40x40

13.243  x20

## TEXTFIX CONTENT

- EN Double-sided aluminum frame profile for textile printing. Black or aluminium finish. Includes: 4 Profiles, 4 corners and 1 Allen key type. Bases not included.
- FR Profil double en aluminium pour des impressions en textile. Disponible en gris ou en noir. 4 profils, 4 équerres et 1 clef Allen inclus. Socles non inclus.
- PT Perfil dupla face em alumínio para impressões têxteis. Disponível em preto ou cinzento. Inclui 4 perfis, 4 esquinas e 1 chave tipo Allen. Pés não incluídos.
- ES Perfil doble para la elaboración de marcos de aluminio. Acabado en negro o aluminio. Incluye: 4 perfiles, 4 esquineros y 1 llave Allen. Bases no incluidas.

## INFORMATION

\*mm

- This set includes: 4 Double-sided profiles, 4 corners and 1 Allen key.
- It's perfectly suitable for dressing and setting up shops, showrooms, offices and fair stands, displaying it as a totem using feet bases available next in TexFix accessories.

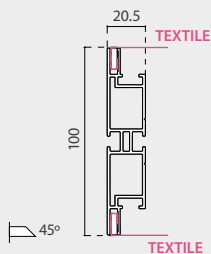

\*Printed on fabric.  
Impression sur toile.  
Impressão em tecido.  
Impresión en tela.

\* The ends are mitred / Couper en biais à 45° / Corte em esquadria de 45° / Cortado a inglete.

## TEXTFIX DETAILS



## TEXTFIX 2-SIDED 100x20.5mm















double sided



**i**

- optional tray at TexFix accessories -

## ALUMINIUM PROFILE SIZES AVAILABLE

100x20.5				100x20.5			
		SIZE				SIZE	
13.300		500mm	x2 	13.303		2000mm	x2 
13.301		1000mm	x2 	13.304		2500mm	x2 
13.302		1500mm	x2 	13.305		3000mm	x2 

## CENTRAL CONNECTOR PROFILE



CONNECTOR \*mm

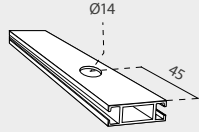

## CORNER CONNECTORS



CORNER	QTY	N.W	G.W	C.B.M	SIZE
Packing	20	0.66kg	0.85kg	0.0005	75x75x90mm
13.333			x20		

## LOCK



LOCK \*mm

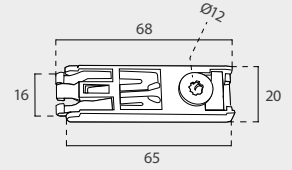

LOCK	QTY	N.W	G.W	C.B.M	SIZE
13.244				x2	

### STANDARD SIZES AVAILABLE

CENTRAL	SIZE	QTY	N.W	G.W	C.B.M	SIZE
13.342	600mm	x2				
13.343	700mm	x2				
13.344	1000mm	x2				
13.345	1500mm	x2				
13.346	2000mm	x2				
13.347	2500mm	x2				
13.348	3000mm	x2				

### LINEAR METERS

CENTRAL	QTY	N.W	G.W	C.B.M	SIZE
Packing	4	5.05kg	5.40kg	0.0147	75x65x3020mm
13.246				4 Uni. x 3m/l=12m/l	



\* the bases at this page are available but not included.

TEXTFIX DETAILS



COMPLETE KIT INCLUDES

PROFILE \*mm

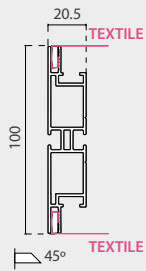
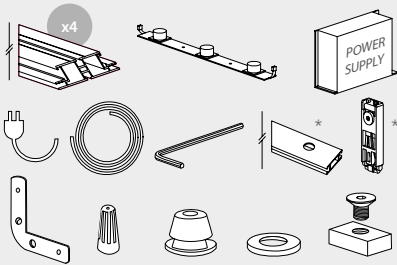

\* Only included in required measures.

The ends are mitted 45°

TEXTFIX COMPLETE KIT  
2-SIDED LIGHT 100x20.5mm



\* Bases and custom textile printing in full color at this page are available but not included

## INFORMATION

The TexFix Complete Kits backlit system is available in several standard sizes (see next pages) and contains everything necessary for assembly. The Kit includes 4 Double-sided profiles (2 horizontal + 2 vertical), corner profile connectors, Allen keys and a complete LED system (LED strips placed in 2000mm sides). The 4 profiles have the corners trimmed to miter and they are available in silver or black. It's ideal for dressing and setting up retail stores, showrooms offices and fair stands, or also, displaying it as a totem using feet bases available next in Texfix accessories.

## TEXTFIX COMPLETE KIT

### 2-SIDED LIGHT 100x20.5mm

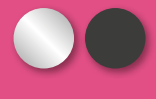

600mm		700mm		1000mm		1500mm		2000mm		2500mm		3000mm		600mm
LED 500 x1 Uni.		LED 500 x1 Uni. Use in 600mm sides		LED 500 x1 Uni. Use in 600mm sides		LED 500 x2 Uni. Use in 600mm sides		LED 300 x1 Uni. + LED 500 x3 Uni. (In 2000mm sides)		LED 500 x3 Uni.   LED 300 x2 Uni. (In 2500mm sides)		LED 500 x4 Uni.   LED 300 x2 Uni. (In 3000mm sides)		
60W 24Vx1 Uni		60W 24Vx1 Uni		60W 24Vx1 Uni		60W 24Vx1 Uni		100W 24Vx1 Uni	1 x Central Connector	100W 24Vx1 Uni	1 x Central Connector	100W 24Vx1 Uni	2 x Central Connectors	
13.308		13.309		13.310		13.311		13.312		13.313		13.314		
LED 500 x1 Uni.v		LED 500 x1 Uni. Use in 700mm side		LED 500 x2 Uni. Use in 700mm sides		LED 300 x1 Uni. + LED 500 x3 Uni. (In 2000mm sides)		LED 500 x3 Uni.   LED 300 x2 Uni. (In 2500mm sides)		LED 500 x4 Uni.   LED 300 x2 Uni. (In 3000mm sides)				700mm
60W 24Vx1 Uni		60W 24Vx1 Uni		60W 24Vx1 Uni		100W 24Vx1 Uni	1 x Central Connector.	100W 24Vx1 Uni	1 x Central Connector	100W 24Vx1 Uni	2 x Central Connectors			
13.315		13.316		13.317		13.318		13.319		13.320				
LED 500 x1 Uni. LED 300 x1 Uni.		LED 500 x2 Uni. LED 300 x1 Uni.		LED 500 x6 Uni. + LED 300 x2 Uni. (In 2000mm sides)		LED 500 x6 Uni.   LED 300 x4 Uni. (In 2500mm sides)		LED 500 x8 Uni.   LED 300 x4 Uni. (In 3000mm sides)						1000mm
60W 24Vx1 Uni. (in 1000mm sides)		60W 24Vx1 Uni. (in 1500mm sides)		150W 24Vx1 Uni	1 x Central Connector	150W 24Vx1 Uni	1 x Central Connector	200W 24Vx1 Uni	2 x Central Connectors					
13.321		13.322		13.323		13.324		13.325						
LED 500 x4 Uni.   LED 300 x2 Uni. (In 1500mm sides)		LED 500 x6 Uni.   LED 300 x2 Uni. (In 2000mm sides)		LED 500 x6 Uni.   LED 300 x4 Uni. (In 2500mm sides)		LED 500 x8 Uni.   LED 300 x4 Uni. (In 3000mm sides)								1500mm
100W 24Vx1 Uni. (in 1500mm sides)		150W 24Vx1 Uni	1 x Central Connector	150W 24Vx1 Uni	1 x Central Connector	200W 24Vx1 Uni	2 x Central Connectors							
13.326		13.327		13.328		13.329								
LED 500 x6 Uni.   LED 300 x2 Uni. (In 2000mm sides)		LED 500 x6 Uni.   LED 300 x4 Uni. (In 2500mm sides)		LED 500 x8 Uni.   LED 300 x4 Uni. (In 3000mm sides)										2000mm
200W 24Vx1 Uni	2 x Central Connectors	200W 24Vx1 Uni	2 x Central Connectors	200W 24Vx1 Uni	2 x Central Connectors									
13.330		13.331		13.332										

**new.**

TEXTFIX CONTENT



\*Printed on fabric.  
Impression sur toile.  
Impressão em tecido.  
Impresión en tela.

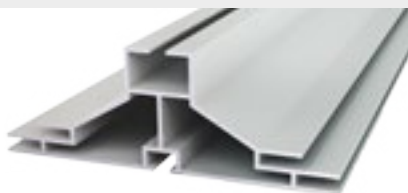

- EN Double-sided aluminum profile for frames. Textile digital printing.
- FR Profil double en aluminium pour des impressions digitales en textile.
- PT Perfil dupla face em alumínio para colocação de impressões têxteis digitais.
- ES Perfil doble de aluminio para elaborar marcos. Impresión digital sobre textil.







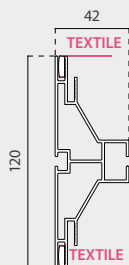

INFORMATION

\*mm

- Featuring 120x42mm double sided profile frame design.
- Fast TexFix is really simple and quick to assemble.
- It's ideal for wall mounting at showrooms, expositions or windows/shop dressing.



ALUMINIUM PROFILE SIZES AVAILABLE

FAST		SIZE
13.492		 2 Uni. x 500mm
13.491		 2 Uni. x 1000mm
13.490		 2 Uni. x 2000mm
13.489		 2 Uni. x 3000mm

FAST CORNER CONNECTOR



- EN Corner connector.
- FR Connexion d'angle.
- PT Esquina.
- ES Esquinero.

CORNER CONNECTOR

\*mm

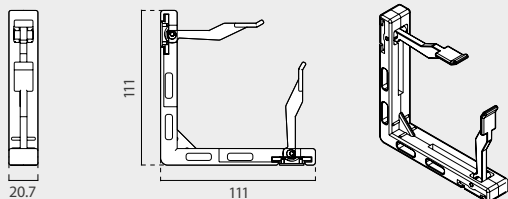

FAST CORNER

13.493	 x4
--------	--

FAST TEXTFIX  
2-SIDED 120x42mm



## TEXTFIX CONTENT



\*Printed on fabric.  
Impression sur toile.  
Impressão em tecido.  
Impresión en tela.



- EN Double-sided aluminum profile for frames. Textile digital printing.
- FR Profil double en aluminium pour des impressions digitales en textile.
- PT Perfil dupla face em alumínio para colocação de impressões têxteis digitais.
- ES Perfil doble de aluminio para elaborar marcos. Impresión digital sobre textil.

## INFORMATION

\*mm

- Featuring 120x20.5mm double sided profile frame design.
- Fast TexFix is really simple and quick to assemble.
- It's ideal for wall mounting at showrooms, expositions or windows/shop dressing.

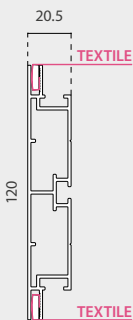

## PROFILE DETAILS



## ALUMINIUM PROFILE SIZES AVAILABLE

FLAT		SIZE
13.650	 	 2 Uni. x 2000mm
13.651	 	 2 Uni. x 3000mm
13.652	 	 2 Uni. x 4000mm

## FLAT TEXTFIX 2-SIDED 120x20.5mm



simple  
set-up



## CORNER

13.333  x20

## CORNER CONNECTORS

CONNECTOR \*mm

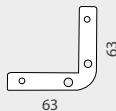

TEXTIFIX CONTENT



\*Printed on fabric.  
Impression sur toile.  
Impressão em tecido.  
Impresion en tela.



TEXTIFIX 2-SIDED 150mm

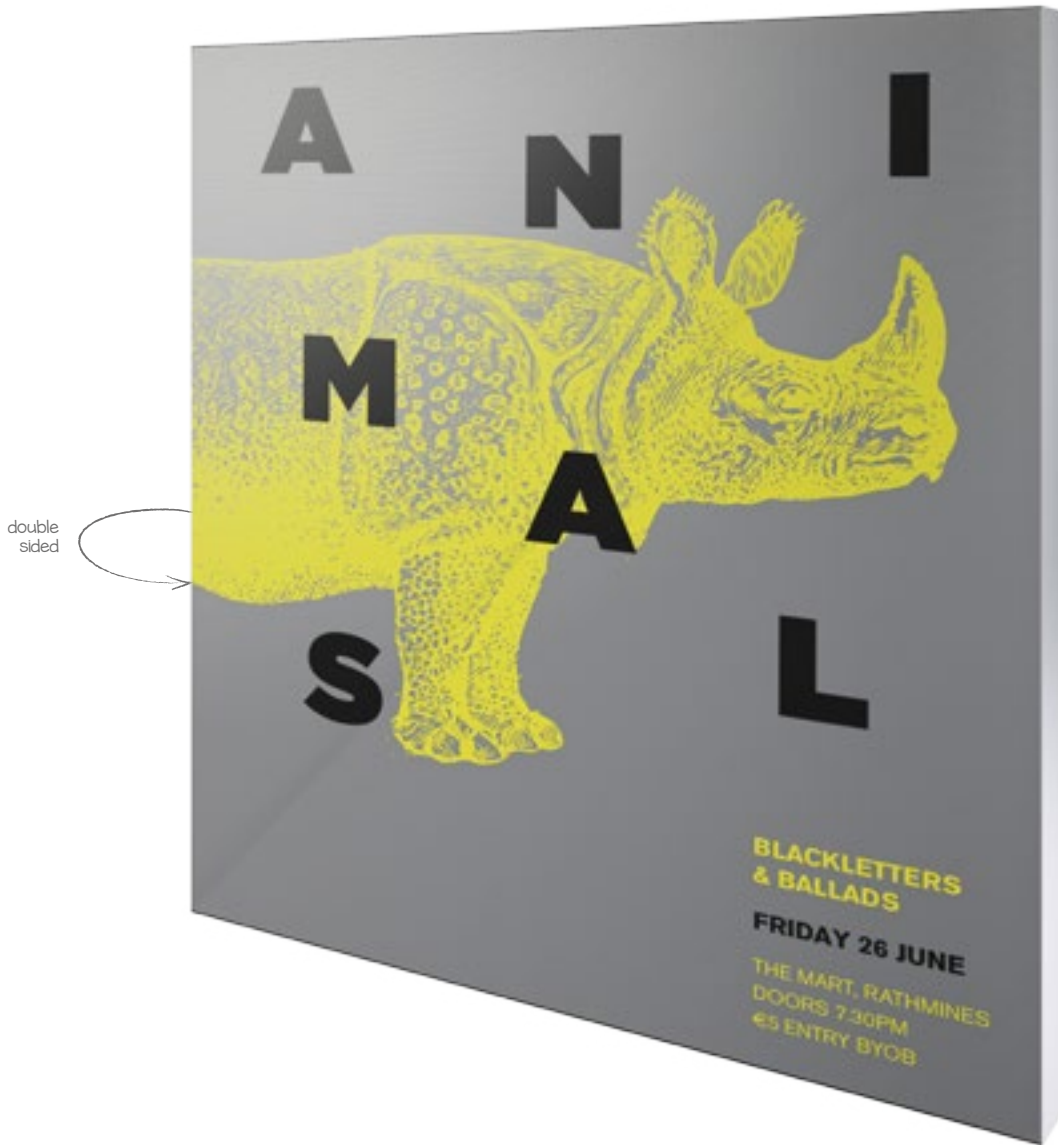

ALUMINIUM PROFILE SIZES AVAILABLE

150mm	SIZE	
13.653		 2 Uni. x 2000mm
13.654		 2 Uni. x 3000mm
13.655		 2 Uni. x 4000mm

INFORMATION

\*mm

- This set includes: 4 Double-sided profiles, 4 corners and 1 Allen key.
- It's perfectly suitable for dressing and setting up shops, showrooms, offices and fair stands, displaying it as a totem using feet bases available next in TexFix accessories.

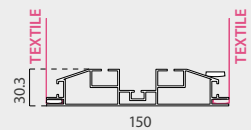



### CORNER CONNECTORS



CORNER

13.333      x20 

CONNECTOR \*mm

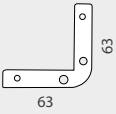

### CORNER CONNECTORS



CORNER 40x40

13.243      x20 

simple set-up

CONNECTOR \*mm



### CORNER CONNECTOR

\*mm

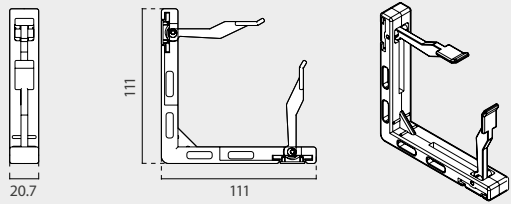

20.7      111      111

### FAST CORNER CONNECTOR

EN	Corner connector.	PT	Esquina.
FR	Connexion d'angle.	ES	Esquinero.

FAST CORNER

13.493      x4 



## 41mm PROFILE FOR STANDS

### PROFILE

\*mm

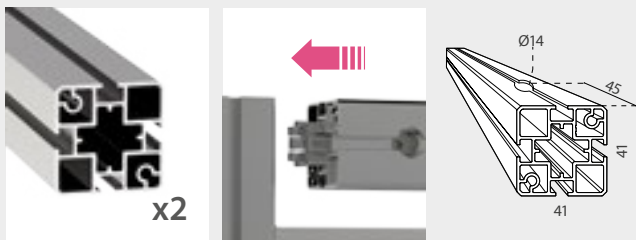

### INFORMATION

This range of Aluminum Profiles, its flexibility allows for the creation of stands, such as point of sale units, light boxes, display stands, cabinets, double deck, showcases, custom modular exhibition stand and retail interior. These 41mm profiles are made of anodized aluminium. Each pack includes 2 aluminium 41mm profile bars (3 sizes available).

#### ALUMINIUM PROFILE SIZES AVAILABLE

41 PROFILE	SIZE	
13.660		 2 Uni. x 2000mm
13.661		 2 Uni. x 3000mm
13.662		 2 Uni. x 4000mm

## STAND TEXFIX 41mm



## BASES FOR 41mm PROFILE

### INFORMATION | ASSEMBLY

These bases for 41mm profiles are made of 4mm thickness steel sheet, with grey lacquered finish (Ral 9006). Each pack includes 2 Bases with screws and Leveling feet included.

1. 41mm profile
2. Metallic base
3. M4.8 L50 screws
2. Leveling foot M8

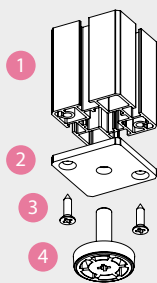

#### 41mm BASES

41 BASE		
13.663		x2 

## LOCK

### LOCK DETAILS



### INFORMATION

\*mm

This Lock is suitable for connecting frames of TexFix structures with the Central Connector Profiles, ideal for providing a stable TexFix profile structure. With an easy and fast set up.

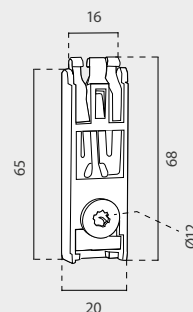

LOCK		
13.244		x2 

## 105mm PROFILE FOR STANDS

### PROFILE

\*mm



### INFORMATION

This range of Aluminum Profiles, its flexibility allows for the creation of stands, such as point of sale units, light boxes, display stands, cabinets, double deck, showcases, custom modular exhibition stand and retail interior. These 105mm profiles are made of anodized aluminium. Each pack includes 2 aluminium 105mm profile bars (3 sizes available).

#### ALUMINIUM PROFILE SIZES AVAILABLE

105 PROFILE	SIZE
13.656	 2 Uni. x 2000mm
13.657	 2 Uni. x 4000mm
13.658	 1 Uni. x 6000mm

## BASES FOR 105mm PROFILE

### INFORMATION | ASSEMBLY

These bases for 105mm profiles are made of 4mm thickness steel sheet, with grey lacquered finish (Ral 9006). Each pack includes 2 Bases with screws and Leveling feet included.

1. 105mm profile
2. Metallic base
3. M5.5 L60 screws
2. Leveling foot M10

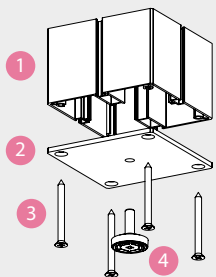

#### 105mm BASES

105 BASE	
13.659	 x2 

## TEXFIX FRAME 105mm FOR STANDS



## LOCK

### LOCK DETAILS



### INFORMATION

\*mm

This Lock is suitable for connecting frames of TexFix structures with the Central Connector Profiles, providing a stable TexFix profile structure. With an easy and fast set up.

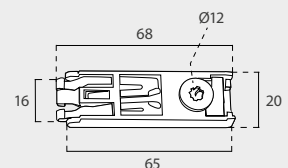

LOCK	
13.244	 x2 

## HANGER FOR FRAME 16mm

### HANGER DETAILS

\*mm



HANGERS 16	QTY	N.W	G.W	C.B.M	SIZE
Packing	20	0.31kg	0.45kg	0.0004	85x45x115mm
13.172	x20 				

## HANGER RING CLIP

### HANGER DETAILS

\*mm



HANGERS	QTY	N.W	G.W	C.B.M	SIZE
Packing	10	0.04kg	0.10kg	0.0004	65x10x65mm
10.197	x10 				

## CORNER CONNECTOR 36x36mm

### CONNECTOR DETAILS



### INFORMATION

\*mm

This Connector is suitable for connecting profiles of TexFix structures, providing stable corner unions. With screws for an easy and fast set up.

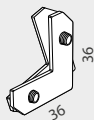

CORNER 1	
13.171	x20 

## CORNER CONNECTOR 40x40mm

### CONNECTOR DETAILS



### CONNECTOR

\*mm

This 40x40mm Connector is suitable for connecting profiles of TexFix structures, providing stable corner unions. With screws for an easy set up.

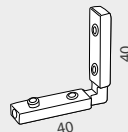

CORNER 40x40	
13.243	x20 

## CORNER CONNECTOR 63x63mm

### CONNECTOR DETAILS



### CONNECTOR

\*mm

This 63x63mm Connector is suitable for connecting profiles of TexFix structures, providing stable corner unions.

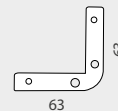

CORNER 1	
13.333	x20 

### STRIP DETAIL



### INFORMATION

This white silicone is ± 12mm width. The strip, once sewn to the fabric, allows to create a guide which is inserted into the grid of the profile being tight and perfectly framed.

SILICONE STRIP	QTY	N.W	G.W	C.B.M	SIZE
Packing	1	0.45kg	0.52kg	0.0021	100x80x265mm
13.173	10m./l				

## SILICONE STRIP



## STRAIGHT BASE



### BASE DETAILS



### INFORMATION

\*mm

This stable straight base for Textfix is made of metal and it is available in black or silver color.

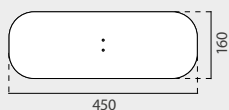

STRAIGHT	QTY	N.W	G.W	C.B.M	SIZE
Packing	1	5.9kg	6.1kg	0.0031	175x35x510mm
13.175	 	160x450mm		x2	

## BASE 'S'



### BASE DETAILS





### INFORMATION

\*mm

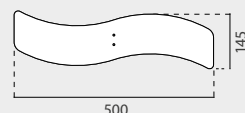
This stable "S" shape base for Textfix is made of metal and it is available in black or silver color.



BASE 'S'	QTY	N.W	G.W	C.B.M	SIZE
Packing	1	4.5kg	4.7kg	0.0031	175x35x510mm
13.174	 	145x500mm		x2	

## BOWTIE TEXTFIX BASE

### BASE DETAILS

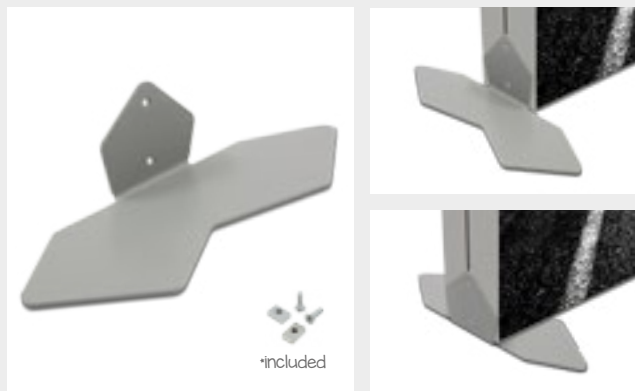

### INFORMATION

\*mm

Made of Steel of 4mm of thickness, grey color (RAL 9006). It can be used in 2 ways (in or out). It has protective round pads at the bottom.



BOW BASE	QTY	N.W	G.W	C.B.M	SIZE
Packing	1	2.1kg	5.07kg	0.0143	521x200x137mm
13.474	Width: 426mm		x2		

## FIN TEXTFIX BASE

### BASE DETAILS



### INFORMATION





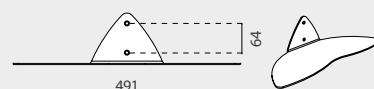

\*mm

Made of Steel of 4mm of thickness, grey color (RAL 9006). It can be used in 2 ways (in or out). It has protective round pads at the bottom.



FIN BASE	QTY	N.W	G.W	C.B.M	SIZE
Packing	1	2.38kg	5.07kg	0.0143	521x200x137mm
13.480	Width: 491mm		x2		

STANDARD SIZES AVAILABLE

CENTRAL	SIZE
13.342	600mm x2 
13.343	700mm x2 
13.344	1000mm x2 
13.345	1500mm x2 
13.346	2000mm x2 
13.347	2500mm x2 
13.348	3000mm x2 

LINEAR METERS

CENTRAL	QTY	N.W	G.W	C.B.M	SIZE
Packing	4	5.05kg	5.40kg	0.0147	75x65x3020mm
13.246		4 Uni. x 3m/l=12m/l			

LOCK

LOCK DETAILS

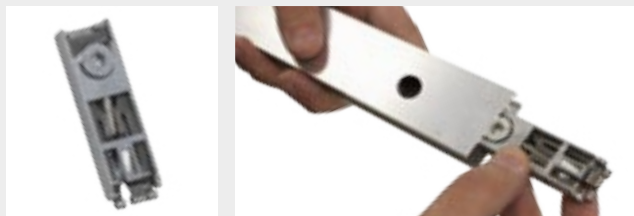

INFORMATION

\*mm

This Lock is suitable for connecting frames of TexFix structures with the Central Connector Profiles, providing a stable TexFix profile structure. With an easy and fast set up.

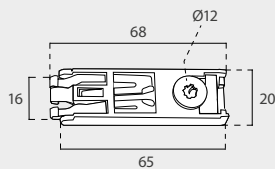

LOCK

13.244	x2 
--------	--

CENTRAL CONNECTOR PROFILE

CONNECTOR DETAILS



INFORMATION

\*mm

This Central Connector Profiles is ideal for connecting frames of TexFix structures. 7 Standard sizes available and also, linear meters option is available. It is made of aluminium. Suitable for being used with Lock.

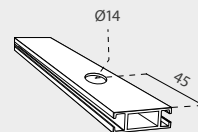

CABLE HOLDER FOR TEXTFIX

LOCK DETAILS





INFORMATION

\*mm

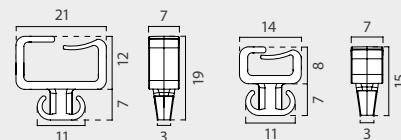
These Cable Holder are ideal for being used with the interior cable of TexFix Frames. 2 sizes are available.



HOLDER 21	QTY	N.W	G.W	C.B.M	SIZE
Packing	1	0.016kg	0.25kg	0.0003	170x100x15mm
13.772	x20 				
HOLDER 14	QTY	N.W	G.W	C.B.M	SIZE
Packing	1	0.008kg	0.015kg	0.0003	170x100x15mm
13.773	x20 				

WALL HANGERS FOR CANVAS

HANGER DETAIL

INFORMATION

DIMENSIONS

\*mm



Wall Hanger for Canvas is suitable for being used with the next profiles: TexFix Canvas, TexFix 80 and TexFix UltraSlim

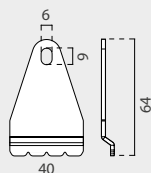

CENTRAL	QTY	N.W	G.W	C.B.M	SIZE
Packing	4	0.31kg	0.45kg	0.0004	85x45x15mm
13.708	x4 				

WALL HANGER FOR TEXTFIX 100-150

HANGER DETAILS

INFORMATION

\*mm

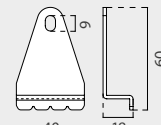

Suitable for hanging Texfix from walls. 2mm thickness steel sheet.

HANGER	QTY	N.W	G.W	C.B.M	SIZE
Packing	1	0.135kg	0.145kg	0.0003	170x100x15mm
13.774	x4 				

# TEXTFIX ACCESSORIES TV Support | Steel Tray

## SUPPORT DETAIL

## INFO SET-UP \*mm

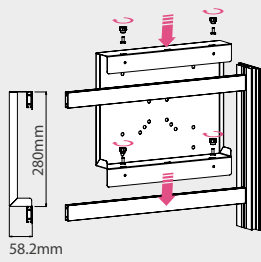

## INFORMATION \*mm

This TV Support for TexFix is suitable for being used with 100mm profiles. Set Up is very simple, it hangs from Central Connector Profiles and it adjusts thanks its screws (included). Ideal for displaying media promotions through TV Panels.

TV SUPPORT	QTY	N.W	G.W	C.B.M	SIZE	
Packing	1	1.67kg	1.95kg	0.0084	365x355x65mm	
13.597			x1			

## TV SUPPORT FOR TEXTFIX 100mm



## TRAY DETAILS

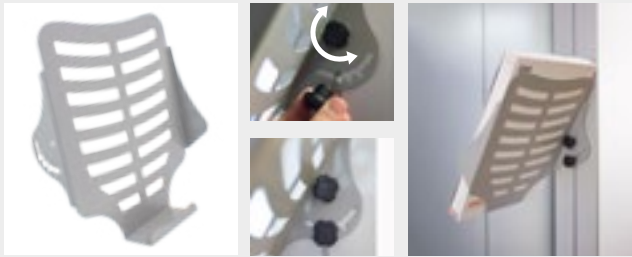

## STEEL TRAYS DIMENSIONS \*mm

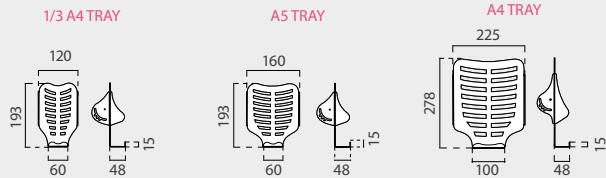

1/3 A4 TRAY	QTY	N.W	G.W	C.B.M	SIZE
Packing	1	0.55kg	0.80kg	0.003	240x130x120mm
13.440	Left	1/3 A4	x2		
13.441	Right	1/3 A4	x2		

A5 TRAY	QTY	N.W	G.W	C.B.M	SIZE
Packing	1	0.70kg	0.85kg	0.005	240x175x120mm
13.442	Left	A5	x2		
13.443	Right	A5	x2		

A4 TRAY	QTY	N.W	G.W	C.B.M	SIZE
Packing	1	1.25kg	1.60kg	0.009	330x240x120mm
13.444	Left	A4	x2		
13.445	Right	A4	x2		

## STEEL TRAY FOR TEXTFIX 100





### DISPLAY DETAILS

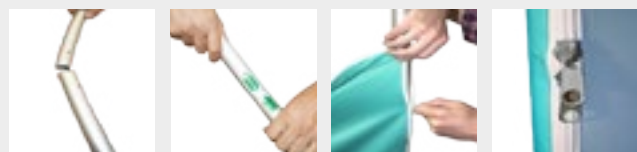

### DIMENSIONS

\*mm

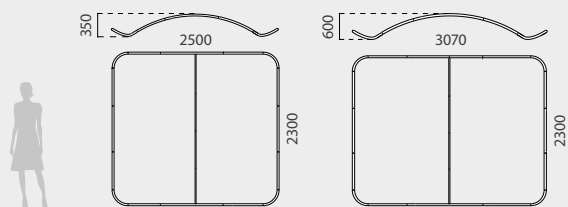

### GRAPHIC FOR TEXTILE

\*mm

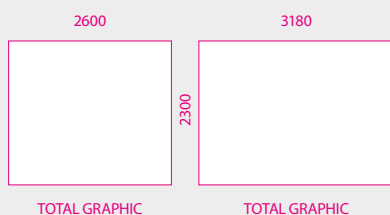

\*Printed on textile.  
Impression sur toile.  
Impressão em tecido.  
Impresión en tela.



### INFORMATION

The Tension Display features a curved lightweight aluminum structure that assembles in a few minutes. A padded canvas carrying bag included for an easy storage and transportation. Denote your stand or photocall with the innovative design and versatility of textile printing. Ideal as a divider for a meeting or as a stand-alone photocall for advertisements and promotional events. The Kano Tension Textile Wall features a 3x3 or 4x3 ratio available.

KANO 1	QTY	N.W	G.W	C.B.M	SIZE
Packing	1	10.7kg	12.2kg	0.0284	240x160x740mm
15.220	Graphic Size: 2600x2300mm				
KANO 2	QTY	N.W	G.W	C.B.M	SIZE
Packing	1	12.7kg	14.2kg	0.0343	290x160x740mm
15.221	Graphic Size: 3180x2300mm				

\* Custom textile printing in full color is available but not included.

## KANO

“

Ideal for being used with Spotlights (not included)

”







### BAMAKO



“  
Ideal for being used with  
Spotlights (not included)  
”



#### DISPLAY DETAILS

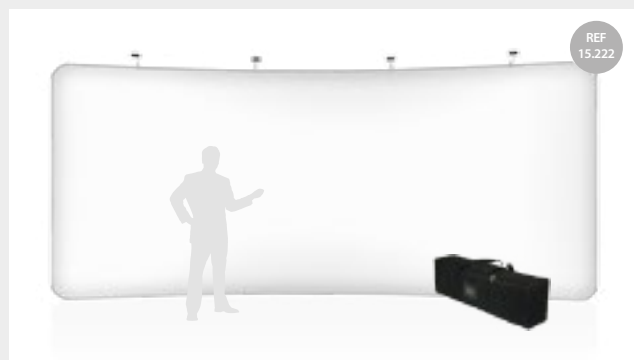

#### INFORMATION

The Bamako Tension Wall features a curved lightweight aluminum structure that assembles in a few minutes. A padded canvas carrying bag included for an easy storage and transportation. Create a 5280x2300mm big photocall with the innovative design and versatility of textile printing. Bamako is ideal for being used as divider for a meeting or as a stand-alone photocall for advertisements and promotional events. The Bamako Tension Textile Wall features a 7x3 ratio.

BAMAKO	QTY	N.W	G.W	C.B.M	SIZE
Packing	1	17.1kg	18.6kg	0.046	390x160x740mm
15.222	Graphic Size: 5420x2300mm				

\* Custom textile printing in full color is available but not included.

#### DIMENSIONS

\*mm

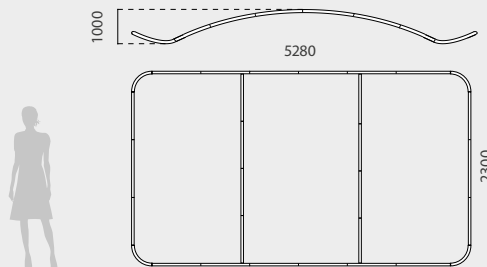

#### GRAPHIC FOR TEXTILE

\*mm



TOTAL GRAPHIC

\*Printed on textile.  
Impressão sur toile.  
Impressão em tecido.  
Impresión en tela.



## KAYES 2x3



 optional spotlight  
- sold apart -



\*Printed on textile.  
Impression sur toile.  
Impressão em tecido.  
Impresión en tela.



### EXTERNAL SIZE

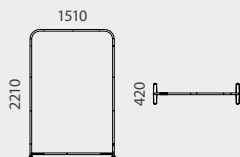

### ARTWORK

\*mm

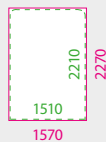

SAFE ZONE  
TOTAL GRAPHIC

### EXTERNAL SIZE

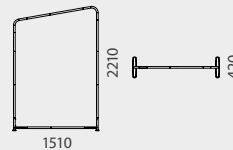

### ARTWORK

\*mm

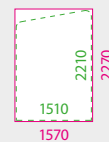

SAFE ZONE  
TOTAL GRAPHIC

### INFORMATION

Kayes features a 2x3 ratio, with a lightweight aluminum frame that assembles quickly. Carrying bag is included for an easy storage and transportation. 2 shapes available. Denote your stand or photocall with the innovative design and versatility of textile printing. Ideal as a divider or as photocall for advertisements and promotions.

KAYES 1	QTY	N.W	G.W	C.B.M	SIZE
Packing	1	15.1kg	17.6kg	0.022	190x160x740mm
15.223	Graphic Size: 1570x2270mm				

\* Custom textile printing in full color is available but not included.

KAYES 2	QTY	N.W	G.W	C.B.M	SIZE
Packing	1	15.1kg	17.6kg	0.022	190x160x740mm
15.233	Graphic Size: 1570x2270mm				

\* Custom textile printing in full color is available but not included.

### EXTERNAL SIZE

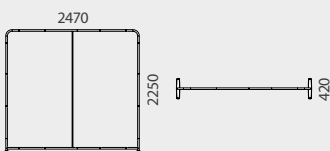

### ARTWORK

\*mm

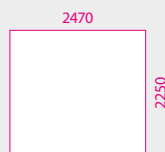

TOTAL GRAPHIC

### INFORMATION

Bilma features a 3x3 ratio, with a straight lightweight aluminum frame. Carrying bag is included for an easy storage and transportation. Denote your stand or photocall with the innovative design and versatility of textile printing. Ideal as a divider or as a photocall for advertisements and promotions.

BILMA	QTY	N.W	G.W	C.B.M	SIZE
Packing	1	17.1kg	18.6kg	0.028	240x160x740mm
15.224	Graphic Size: 2470x2250mm				

\* Custom textile printing in full color is available but not included.

## BILMA 3x3



\*Printed on textile.  
Impression sur toile.  
Impressão em tecido.  
Impresión en tela.

## NIAMEY 4x3

 optional spotlight - sold apart -

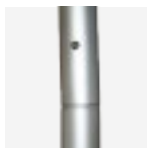

\*Printed on textile.  
Impression sur toile.  
Impressão em tecido.  
Impresión en tela.

### INFORMATION

Niamey features a 4x3 ratio, with a straight lightweight aluminum frame. Carrying bag is included for an easy storage and transportation. Denote your stand or photocall with the innovative design and versatility of textile printing. Ideal as a divider or as a photocall for advertisements and promotions.

NIAMEY	QTY	N.W	G.W	C.B.M	SIZE
Packing	1	12.7kg	14.2kg	0.034	290x160x740mm
15.225	Graphic Size: 2950x2250mm				

\* Custom textile printing in full color is available but not included.

### EXTERNAL SIZE

### ARTWORK

\*mm

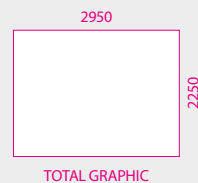
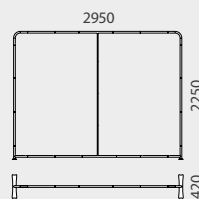

## DAKAR 7x3

easy to assemble



\*Printed on textile.  
Impression sur toile.  
Impressão em tecido.  
Impresión en tela.

### INFORMATION

Dakar features a large 7x3 ratio, with a straight lightweight aluminum frame. The graphic textile set attaches with a zipper underneath the frame for a seamless appearance. A canvas bag is included for an easy transportation. Denote your stand with the innovative design and versatility of the textile printing. Great for using at a trade show or at any media event.

DAKAR	QTY	N.W	G.W	C.B.M	SIZE
Packing	1	17.10kg	18.60kg	0.046	390x160x740mm
15.226	Graphic Size: 5830x2250mm				

\* Custom textile printing in full color is available but not included.

### EXTERNAL SIZE

### ARTWORK

\*mm

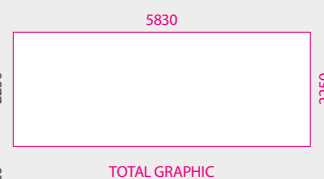
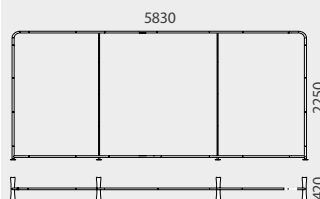

### ZAMBIA

“

Ideal for being used with Spotlights (not included)

”



denote your stand or photocal

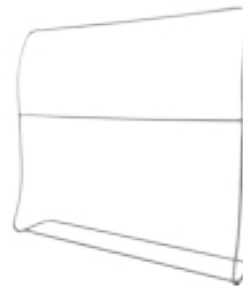
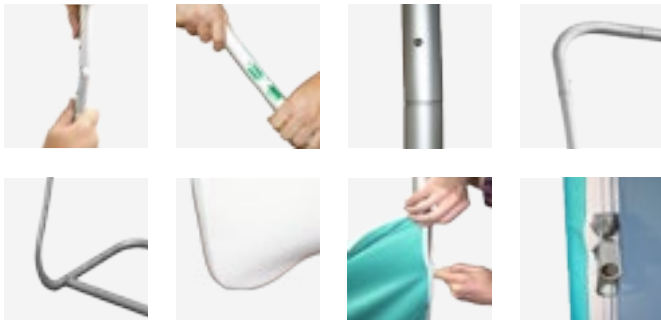

\*Printed on textile.  
Impression sur toile.  
Impressão em tecido.  
Impresión en tela.

#### INFORMATION

Zambia display features a lightweight aluminum frame that assembles in minutes. The graphic textile set attaches with a zipper underneath the frame for a seamless appearance. A canvas bag is included for an easy transportation. Denote your stand or photocal with the innovative design and versatility of the textile printing. Great for using at trade shows or at any media event.

ZAMBIA	QTY	N.W	G.W	C.B.M	SIZE
Packing	1	9.25kg	10.1kg	0.0463	310x180x830mm
15.219		Graphic Size: 2240x2860mm			

#### EXTERNAL SIZE

#### ARTWORK

\*mm

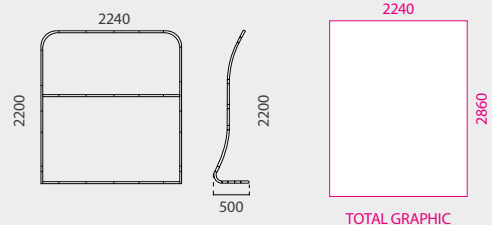

TOTAL GRAPHIC

\* Custom textile printing in full color is available but not included.

# NAMIBIA

“  
Ideal for being used with  
Spotlights (not included)  
”



Ideal for a meeting point

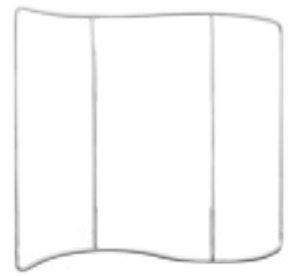

\*Printed on textile.  
Impression sur toile.  
Impressão em tecido.  
Impresión en tela.



### INFORMATION

Namibia display features a curved lightweight aluminum frame. A padded canvas carrying bag included for an easy storage and transportation. Denote your stand or tradebooth with the innovative design and versatility of textile printing. Ideal as a divider for a meeting or as a stand-alone photocall for advertisements and promotions at tradeshows or at any media event.

### EXTERNAL SIZE

### ARTWORK

\*mm

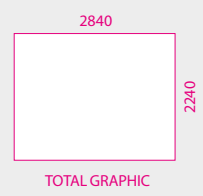
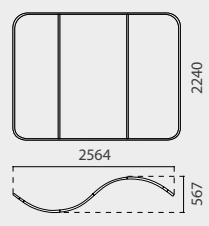

NAMIBIA	QTY	N.W	G.W	C.B.M	SIZE
Packing	1	9.4kg	10.3kg	0.0463	310x180x830mm
15.218	Graphic Size: 2840x2240mm				

\* Custom textile printing in full color is available but not included.

# BANGUI

“

Ideal for being used with Spotlights (not included)

”



\*Printed on textile.  
Impression sur toile.  
Impressão em tecido.  
Impresión en tela.

## INFORMATION

The Bangui display features a curved lightweight aluminum frame. Also a padded canvas carrying bag is included for an easy storage and transportation. Denote your tradebooth with the two useful wooden shelves included and the innovative design and versatility of textile printing. Great for using at trade shows or at any media event.

BANGUI	QTY	N.W	G.W	C.B.M	SIZE
Packing	1	15.95kg	16.90kg	0.0772	470x155x1060mm
15.215		Graphic Size: 2600x2200mm			

\* Custom textile printing in full color is available but not included.

## EXTERNAL SIZE

## ARTWORK

\*mm

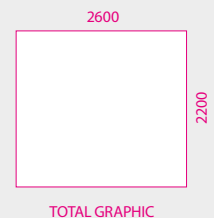
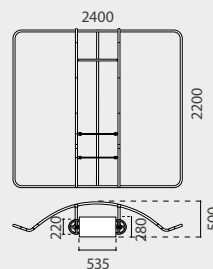

TOTAL GRAPHIC

# KENIA

“  
Ideal for being used with  
Spotlights (not included)  
”



\*Printed on textile.  
Impression sur toile.  
Impressão em tecido.  
Impresión en tela.

## INFORMATION

Kenia display features a straight lightweight aluminum frame. A padded canvas carrying bag is included. The graphic textile set attaches with a zipper underneath the frame for a seamless appearance. Denote your stand with the safety holder for tablet and the three useful wooden shelves included. Ideal as a divider for a meeting, advertisements and promotions.

## EXTERNAL SIZE

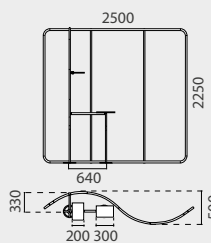

## ARTWORK

\*mm

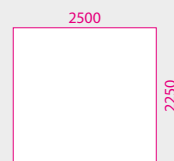

TOTAL GRAPHIC

KENIA	QTY	N.W	G.W	C.B.M	SIZE
Packing	1	16.55kg	17.65kg	0.0772	470x155x1060mm
15.213		Graphic Size: 2500x2250mm			

\* Custom textile printing in full color is available but not included.



### MALI

“

Ideal for being used with Spotlights (not included)

”



Safety Holder for Tablet 244x184mm

\* tablet not included

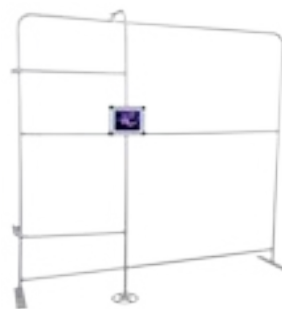
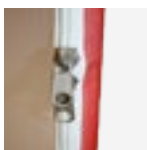
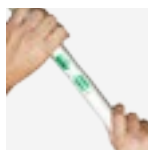
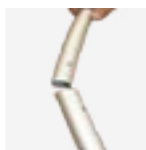
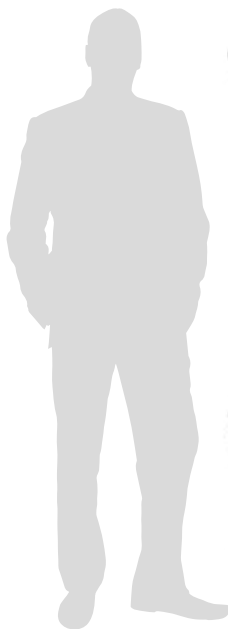

\*Printed on textile.  
Impression sur toile.  
Impressão em tecido.  
Impresión en tela.

#### INFORMATION

Mali tension display features a straight lightweight aluminum frame. A padded canvas carrying bag included for an easy storage and transportation. Denote your stand with the safety holder for tablet included and the innovative design and versatility of textile printing. Ideal as a divider for a meeting, advertisements and promotions.

MALI	QTY	N.W	G.W	C.B.M	SIZE
Packing	1	13.85kg	14.95kg	0.0772	470x155x1060mm
15.214		Graphic Size: 2470x2225mm			

\* Custom textile printing in full color is available but not included.

#### EXTERNAL SIZE

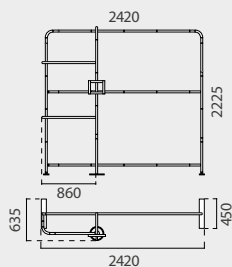

#### ARTWORK

\*mm

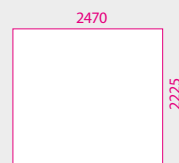

TOTAL GRAPHIC





### BURKINA

“

Ideal for being used with Spotlights (not included)

”



Safety Holder for Tablet 244x184mm

\* tablet not included

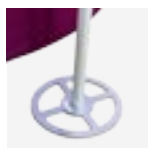
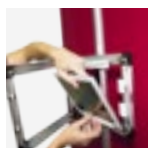

\*Printed on textile.  
Impression sur toile.  
Impressão em tecido.  
Impresión en tela.

#### INFORMATION

Burkina display features a straight lightweight aluminum frame. A padded canvas carrying bag included for an easy storage and transportation. Denote your stand with the safety holder for tablet and the two useful wooden shelves included. Ideal for using as a divider for a meetin or as a photocall for advertisements and promotions at trade shows or at any media event.

BURKINA	QTY	N.W	G.W	C.B.M	SIZE
Packing	1	15.90kg	16.10kg	0.0772	470x155x1060mm
15.216	Graphic Size: 1400x2200mm				

\* Custom textile printing in full color is available but not included.

#### EXTERNAL SIZE

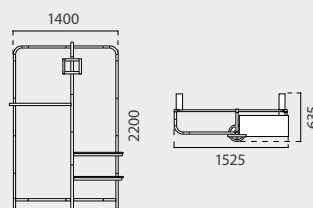

#### ARTWORK

\*mm



TOTAL GRAPHIC



### ITACA WALL ROOM



**i** optional spotlight  
- sold apart -

13.450

13.451



Ideal as a meeting point



\*Printed on textile.  
Impression sur toile.  
Impressão em tecido.  
Impresión en tela.

#### INFORMATION

Itaca display features a lightweight aluminum wall that assembles in minutes. The graphic textile set attaches with a zipper underneath the frame for a seamless appearance. A canvas bag is included for an easy transportation. Denote your stand or photocall with the innovative design and versatility of the textile printing. Great for using at trade shows or at any media event., this event fixture features enough space for setting up counters, chairs or any display and create a conference environment for your business. Ideal for meeting one-on-one with potential customers at a trade show.

ITACA	QTY	N.W	G.W	C.B.M	SIZE
Packing	1	9.5kg	10kg	0.09	1100x300x300mm
15.255		Graphic Size: 4890x1950mm			

\* Custom textile printing in full color is available but not included.

#### EXTERNAL SIZE

#### ARTWORK

\*mm

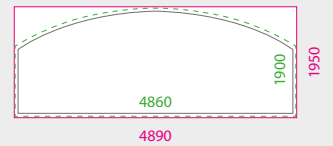
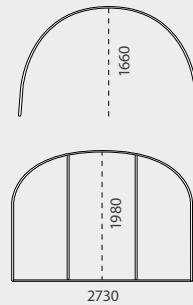

SAFE ZONE  
TOTAL GRAPHIC

#### EXTERNAL SIZE

#### ARTWORK

\*mm

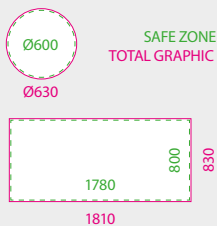
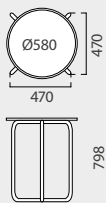

#### INFORMATION

The Delfos table features a Ø580mm wooden surface with a lightweight aluminum structure that assembles in minutes. The graphic textile set attaches with a zipper underneath the frame for a seamless appearance. A canvas bag is included. Ideal for being used with Itaca Wall.

DELFO	QTY	N.W	G.W	C.B.M	SIZE
Packing	1	6.6kg	7kg	0.0544	800x100x680mm
15.257		Graphic Size: 1810x830mm			

\* Custom textile printing in full color is available but not included.

### DELFO

### TABLE



fast  
to set-up



\*Printed on textile.  
Impression sur toile.  
Impressão em tecido.  
Impresión en tela.

## TEBAS CHAIR

EXTERNAL SIZE      ARTWORK      \*mm

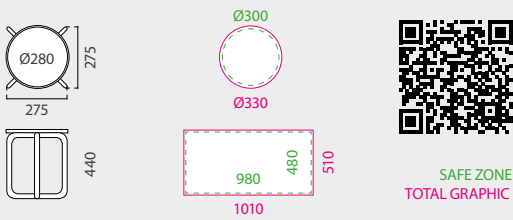

### INFORMATION

The Tebas Chair features a Ø280mm wooden surface with a lightweight aluminum 440mm high structure that assembles in a few minutes. The graphic textile set attaches with a zipper. A canvas bag is included. Ideal for being used with Itaca Wall and Delfos Table.

TEBAS	QTY	N.W	G.W	C.B.M	SIZE
Packing	1	2.5kg	3kg	0.018	450x100x400mm
15.256		Graphic Size: 1010x510mm			

\* Custom textile printing in full color is available but not included.



\*Printed on textile.  
Impression sur toile.  
Impressão em tecido.  
Impresión en tela.



## ALUMINIUM TUBULAR SYSTEM



 \*Printed on textile.  
Impression sur toile.  
Impressão em tecido.  
Impresión en tela.

### INFORMATION

\*mm

This pack of 4 aluminium tubes for tubular system has Ø28mm diameter, it has 1mm of thickness and 3m length. The bars do not bring the holes made, so that the client can determine where to place them. Each pack comes with instructions included. Set up your own aluminum structure using these aluminum tubes with the connecting pieces of the tubular system. Ideal for tradeshows, media events or expositions.



## ALUMINIUM TUBE Ø28 FOR TUBULAR SYSTEM

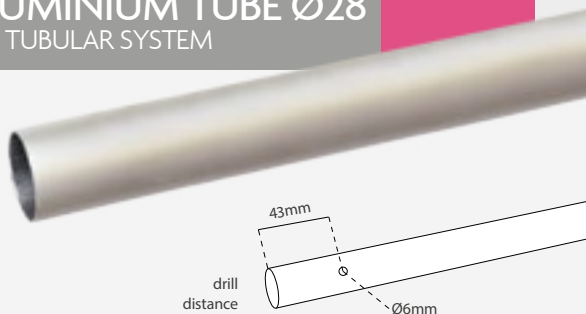

15.258  4 Uni. x 3000mm

## CORNER CONNECTION FOR TUBULAR SYSTEM

## "T" CONNECTION FOR TUBULAR SYSTEM

## CLIP STRIP FOR TUBULAR SYSTEM



### INFORMATION

\*mm

This Corner connection piece is made of polycarbonate and it fits with aluminium tubes by the click system. Clip Strips are included.

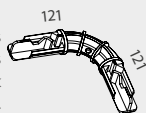

### INFORMATION

\*mm

This "T" shape connection piece is made of polycarbonate and it fits with aluminium tubes by the click system. Clip Strips are included.

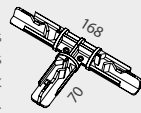



### INFORMATION

\*mm

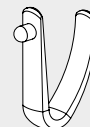
Pack of 10 plastic Clip Strip. This clip fits in tubular connections for the click system.



15.259  x4

15.260  x2

15.261  x10

## SET-UP INFORMATION

The multi-function Tubular System is designed to support several configurations applied by the customer, such as turning it into a Display Totem, a Barrier Banner or a Stand by using tension textil, panels or incorporating bases. Easy to assemble, each piece is designed for quick installation and use. Featuring 3m aluminum tubes without drilling for user's personalization (sold in pack of 4 units), Corner and "T" connections for setting-up structures and Clip Strips for connecting easily the aluminum tubes with corners and "Ts". Denote your stand or tradebooth with your own customizable display or stand. Ideal for setting-up dividers for a meeting or as a stand-alone photocal for advertisements and promotions at tradeshows or at any media event so is a practical display case that will look great in markets, shops, exhibition events or stores.

## ALUMINIUM TUBULAR SYSTEM EXAMPLES



## DISPLAY APPLICATIONS



same structure, different functionality

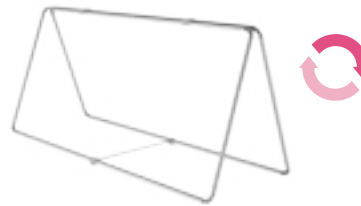

\* Custom textile printing in full color is available but not included.

## STAND APPLICATIONS

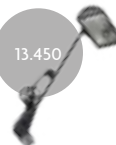
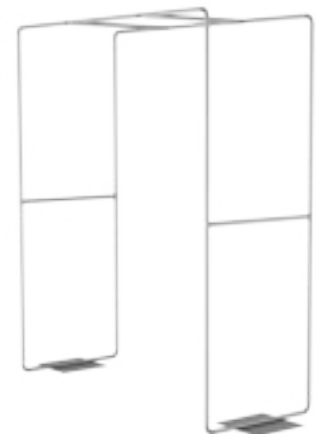

sold apart;  
see accessories

\* Customization possibilities are orientative ideas, in no case are supplied with the display / \* Les possible personnalisation sont à titre indicatif mais ne sont pas incluses dans le display.  
\* As possibilidades de personalização são orientativas, em nenhum caso são fornecidas com o artigo. / \* Las posibilidades de personalización son orientativas, en ningún caso se suministran con el display.



## MAPUKO



graphic size  
700x1700mm

graphic size  
800x1815mm



2 exhibition modes



\*Printed on textile.  
Impression sur toile.  
Impressão em tecido.  
Impresión en tela.

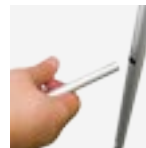
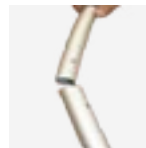

### INFORMATION

Mapuko display features a straight lightweight aluminum frame. It features 2 exhibition modes available. Carrying bag is included. This 2-sided textile banner stand is an excellent upgrade to any trade show booth or event promotion.

MAPUKO	QTY	N.W	G.W	C.B.M	SIZE
Packing	1	3.95kg	4.45kg	0.0285	240x125x950mm
15.217		800x1815mm		700x1700mm	

\* Custom textile printing in full color is available but not included.

### EXTERNAL SIZE

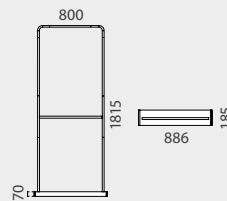

### ARTWORK

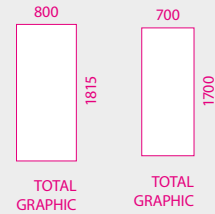

\*mm



## THERA

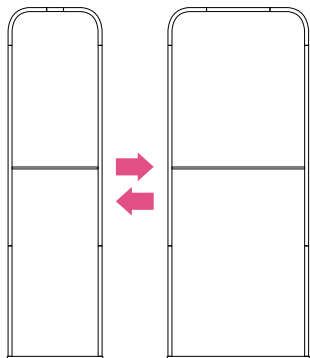

**TEXTILE**  
\*Printed on textile.  
Impression sur toile.  
Impressão em tecido.  
Impresión en tela.

carry bag included



### EXTERNAL SIZES & DOWNLOADABLES ARTWORKS (QR CODE)

\*mm

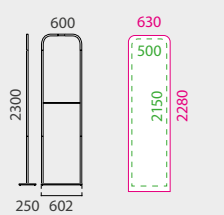

**SAFE ZONE**  
**TOTAL GRAPHIC**

REF 15.245

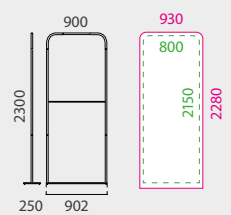

**SAFE ZONE**  
**TOTAL GRAPHIC**

REF 15.246

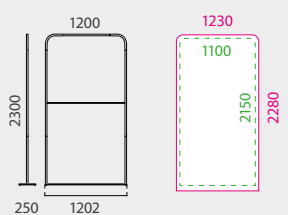

**SAFE ZONE**  
**TOTAL GRAPHIC**

REF 15.247

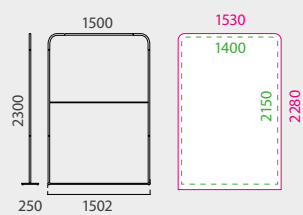

**SAFE ZONE**  
**TOTAL GRAPHIC**

REF 15.248

### INFORMATION

THERA features a linkable lightweight aluminum frame with stable base that assembles quickly. Carrying bag is included. Four widths available. Denote your stand or photocall with the innovative design and versatility of textile printing. Ideal as a divider or stand-alone photocall for advertisements and promotions.

THERA 60	QTY	N.W	G.W	C.B.M	SIZE
Packing	1	6.5kg	8.0kg	0.023	280x105x800mm
15.245	Graphic Size: 630x2280mm				
THERA 90	QTY	N.W	G.W	C.B.M	SIZE
Packing	1	8.5kg	10kg	0.027	280x105x950mm
15.246	Graphic Size: 930x2280mm				

THERA 120	QTY	N.W	G.W	C.B.M	SIZE
Packing	1	10.5kg	12.0kg	0.036	280x105x1250mm
15.247	Graphic Size: 1230x2280mm				
THERA 150	QTY	N.W	G.W	C.B.M	SIZE
Packing	1	12.5kg	14kg	0.045	280x105x1550mm
15.248	Graphic Size: 1530x2280mm				

\* Custom textile printing in full color is available but not included.

\* Custom textile printing in full color is available but not included.

# BOARD



lightweight



easy assembly



\*Printed on textile.  
Impression sur toile.  
Impressão em tecido.  
Impresión en tela.

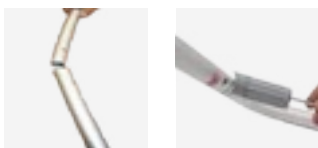

## INFORMATION

Board display features a curved lightweight aluminum frame that assembles in a few minutes. The graphic textile set is attached with a zipper underneath the frame for a seamless appearance. Carrying bag is included for an easy storage and transportation. Denote your stand with the innovative design and versatility of textile printing. Ideal for trade shows or promotional events.

BOARD	QTY	N.W	G.W	C.B.M	SIZE
Packing	1	4.10kg	4.75kg	0.07	800x260x320mm
15.236	Graphic Size: 530x2550mm				

\* Custom textile printing in full color is available but not included.

## EXTERNAL SIZE

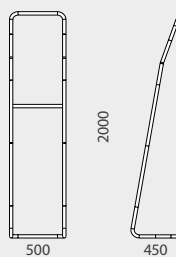

## ARTWORK



FRONT VIEW  
SAFE ZONE  
TOTAL GRAPHIC

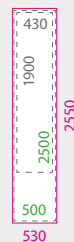

\*mm





LEAF



great visual impact

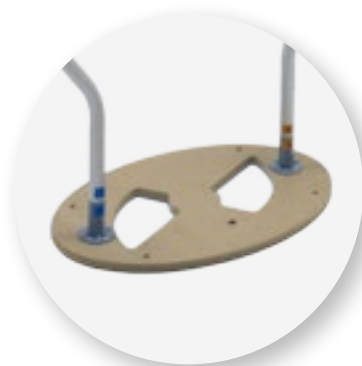

sturdy wooden base



\*Printed on textile.  
Impression sur toile.  
Impressão em tecido.  
Impresión en tela.

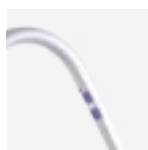
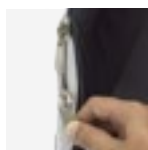

INFORMATION

This display features a leaf shape aluminum frame that assembles in a few minutes. The graphic textile set is attached with a zipper underneath the frame for a seamless appearance. Carrying bag is included for an easy storage and transportation. Denote your stand with the innovative design and versatility of textile printing. Ideal for trade shows or promotional events.

LEAF	QTY	N.W	G.W	C.B.M	SIZE
Packing	1	4.70kg	5.3kg	0.07	1150x140x430mm
15.237		Graphic Size: 960x2090mm			

\* Custom textile printing in full color is available but not included.

EXTERNAL SIZE

ARTWORK

\*mm

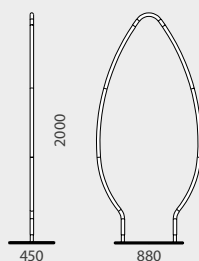

FRONT VIEW  
SAFE ZONE  
TOTAL GRAPHIC

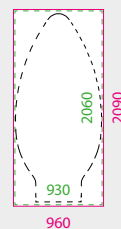



# SNAKE



quick assembly

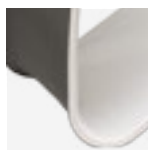

\*Printed on textile.  
Impression sur toile.  
Impressão em tecido.  
Impresión en tela.

## INFORMATION

Snake display features a curved lightweight aluminum frame that assembles in a few minutes. The graphic textile set is attached with a zipper underneath the frame for a seamless appearance. Carrying bag is included for an easy storage and transportation. Denote your stand with the innovative design and versatility of textile printing. Ideal for trade shows or promotional events.

SNAKE	QTY	N.W	G.W	C.B.M	SIZE
Packing	1	5kg	5.75kg	0.05	650x180x430mm
15.234		Graphic Size: 930x3190mm			

\* Custom textile printing in full color is available but not included.

## EXTERNAL SIZE

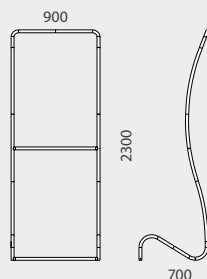

## ARTWORK

\*mm



FRONT VIEW  
SAFE ZONE  
TOTAL GRAPHIC

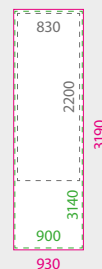

# COBRA



Fast and simple set-up



\*Printed on textile.  
Impression sur toile.  
Impressão em tecido.  
Impresión en tela.

## INFORMATION

Cobra display features a curved lightweight aluminum frame that assembles in a few minutes. The graphic textile set is attached with a zipper underneath the frame for a seamless appearance. Carrying bag is included for an easy storage and transportation. Denote your stand with the innovative design and versatility of textile printing. Ideal for trade shows or promotional events.

COBRA	QTY	N.W	G.W	C.B.M	SIZE
Packing	1	4.9kg	5.7kg	0.05	650x180x430mm
15.235		Graphic Size: 930x2750mm			

\* Custom textile printing in full color is available but not included.

## EXTERNAL SIZE

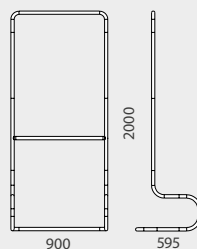

## ARTWORK

\*mm



FRONT VIEW  
SAFE ZONE  
TOTAL GRAPHIC

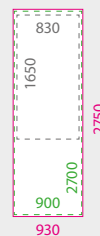



## DISPLAY DETAILS



## EXTERNAL SIZE

## ARTWORK

\*mm

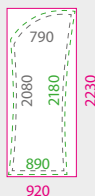
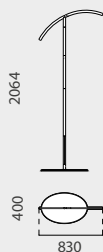

FRONT VIEW  
SAFE ZONE  
TOTAL GRAPHIC



## INFORMATION

Aluminium Tension Textile Display stand with upper curved design. Teguise is an excellent addition to any tradeshow configuration. Available with shelves.

TEGUISE	QTY	N.W	G.W	C.B.M	SIZE
Packing	1	4.9kg	5.32kg	0.04	430x120x610mm
10.198	Graphic Size: 920x2230mm				

## TEGUISE



\*Printed on textile.  
Impression sur toile.  
Impressão em tecido.  
Impresión en tela.

\* Custom textile printing in full color is available but not included.

## DISPLAY DETAILS

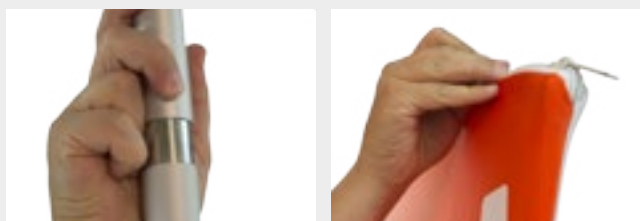

## EXTERNAL SIZE

## ARTWORK

\*mm

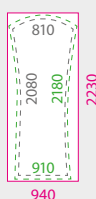

FRONT VIEW  
SAFE ZONE  
TOTAL GRAPHIC



## INFORMATION

Aluminium Tension Textile Display stand with upper curved design. Arona is an excellent addition to any tradeshow configuration. Available with shelves.

ARONA	QTY	N.W	G.W	C.B.M	SIZE
Packing	1	4.9kg	5.32kg	0.04	430x120x610mm
10.205	Graphic Size: 940x2230mm				

## ARONA



\*Printed on textile.  
Impression sur toile.  
Impressão em tecido.  
Impresión en tela.

\* Custom textile printing in full color is available but not included.



## BOARD DETAILS

double sided



REF 15.243

REF 15.242

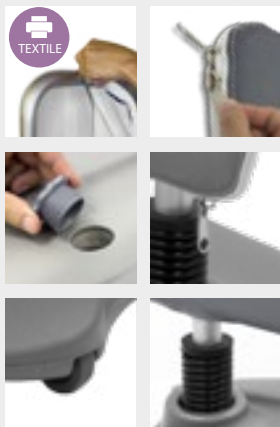

\*Printing on fabric.  
Impression sur toile.  
Impressão em tecido.  
Impresion en tela.

## EXTERNAL SIZES & DOWNLOADABLES ARTWORKS (QR CODE)

\*mm

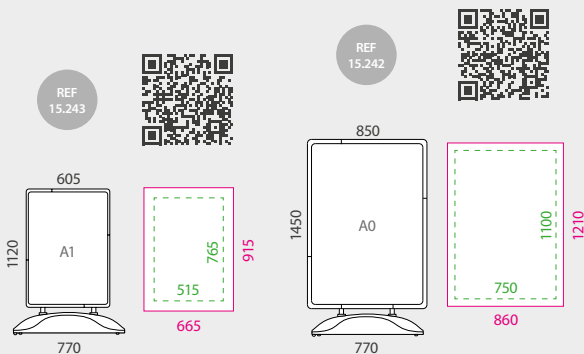

**Capacity**  
Ref. 15.243

**SAFE ZONE**  
**TOTAL GRAPHIC**



**Capacity**  
Ref. 15.242

**SAFE ZONE**  
**TOTAL GRAPHIC**

## INFORMATION

The Mikonos Sidewalk features a lightweight aluminum structure with a refillable plastic base that assembles in seconds (It is 3.95kg weight and it can be filled with 17l of water or sand). Also, the Textile Boards are also simple to setup. All the aluminium poles fit together and snap into base. Simply stretch the wrap over the completed base and it's ready to use. The aluminium structure is affixed to the base with 2 large springs, so it stays stable in windy conditions. Built-in wheels also make this board easy to move as needed. A Nylon Carrying bag is included for an easy storage and transportation. Ideal for denoting your business with the innovative design and versatility of textil printing. The Sidewalk is ideal for being used inside or outside of your restaurant, workshop, street stall, supermarket or heavily-trafficked areas such as tradeshows, events or conventions.

MIKONOS A1	QTY	N.W	G.W	C.B.M	Size (WxHxD)	
Packing	1	75kg	9.5kg	0.11	520x940x230	
15.243	Graphic Size:665x915mm					

MIKONOS A0	QTY	N.W	G.W	C.B.M	Size (WxHxD)	
Packing	1	8kg	10kg	0.11	520x940x230	
15.242	Graphic Size:860x1210mm					

## MIKONOS



\* Custom textil printing in full color is available but not included.

## SPOTLIGHT FOR TENSION TEXTILE DISPLAY

black or grey colored



SPOTLIGHT	QTY	N.W	G.W	C.B.M	SIZE
Packing	1	1kg	1.15kg	0.006	173x60x590mm
13.450	■				Power: 150 W
13.451	■				Power: 150 W

### INFORMATION

\*mm

Trade show display lighting adds the finishing touches needed to impress clients and to create effective presentations. This 150 W spotlight has a suitable fixing design for the tubular structures of the tension textile displays. Once in place, simply plug in the long cable to instantly add brightness. Stylish black or silver finish.

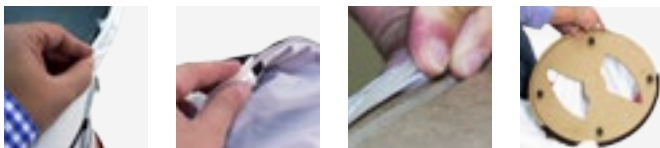
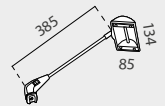

## SILICON STRIP

### INFORMATION

\*mm

Some Tension Textile Displays require that the set of textile graphics be made with a silicone around the perimeter so that these can be correctly introduced into their structures. This silicone is ideal for the manufacturing of textile for the Tension Display stands. It comes in 10m linear pack

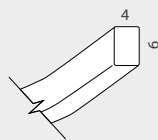

REF 13.465



13.465	Pack 10m/l
--------	------------



### COUNTER DETAILS



\*Printed on fabric.  
Impression sur toile.  
Impressão em tecido.  
Impresión en tela.



### EXTERNAL SIZE

### ARTWORK

\*mm

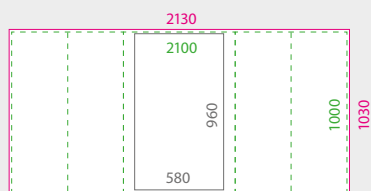
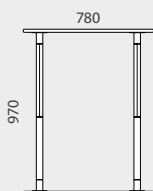

FRONT VIEW  
SAFE ZONE  
TOTAL GRAPHIC



### INFORMATION

These Counters are designed for using with fabric wrap (printed on textile) making it lightweight and easy to fold. Also, the Fabric Counters are also simple to setup. All the aluminium poles fit together and snap into place. Simply stretch the wrap over the completed base and it's ready to use. With carry bag for easy travelling. Features a double zip to the interior of the counter for storing, so your exhibition always appears clean and organized. Baracoa is ideal as a lectern or podium at tradeshow, promotional events or conventions and are great to pair with Pop Up banners or any stand.

BARACOA	QTY	N.W	G.W	C.B.M	SIZE
Packing	1	8kg	9.2kg	0.042	860x120x410mm
13.740	Graphic Size: 2130x1030mm				

## BARACOA





### COUNTER DETAILS



\*Printed on fabric.  
Impression sur toile.  
Impressão em tecido.  
Impresión en tela.

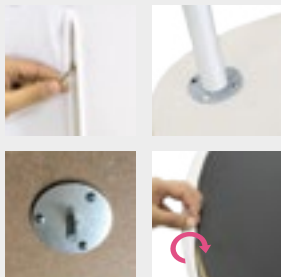

#### EXTERNAL SIZE

\*mm

#### ARTWORK

#### DOWNLOAD

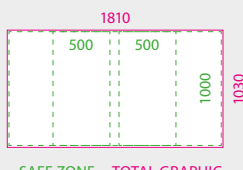
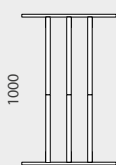

### INFORMATION

Creta is lightweight and easy to fold and setup. With carry bag and a single zip to the interior for storing. Features 3 points of view. Ideal as a lectern or podium at tradeshows, events or conventions.

CRETA	QTY	N.W	G.W	C.B.M	SIZE
Packing	1	11kg	12kg	0.04	650x100x650mm
10.311	Graphic Size: 1810x1030mm				

## CRETA



### COUNTER DETAILS



\*Printed on fabric.  
Impression sur toile.  
Impressão em tecido.  
Impresión en tela.

automatic hydraulic

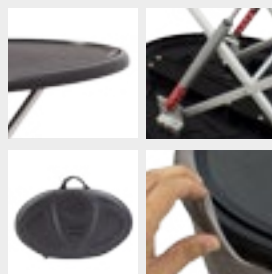

#### EXTERNAL SIZE

\*mm

#### ARTWORK

#### DOWNLOAD

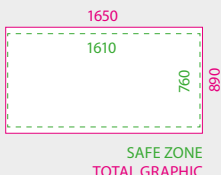
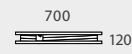
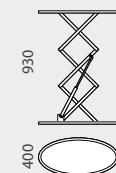

### INFORMATION

Sienna is lightweight and easy to fold and setup. With a hard carry padded bag and a double zip. Features an **hydraulic drive system** for an automatic and quick unfolding with just a slight push on the top of the counter. Ideal for events or conventions and are great to pair with Pop Up banners or any stand.

SIENNA	QTY	N.W	G.W	C.B.M	SIZE
Packing	1	5.6kg	7.6kg	0.21	970x600x360mm
15.244	Graphic Size: 1650x890mm				

## SIENNA



\* Printing is available but not included





### COUNTER DETAILS



\*Printed on fabric.  
Impression sur toile.  
Impressão em tecido.  
Impresión en tela.

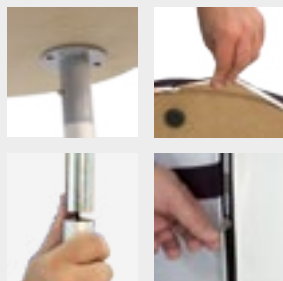

### EXTERNAL SIZE

\*mm

### ARTWORK

### DOWNLOAD

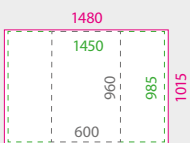

FRONT VIEW SAFE ZONE TOTAL GRAPHIC

### INFORMATION

Manacor is lightweight and fast to setup. Features an oval shape design. With carry bag and a double zip to the interior for storing. Ideal as a lectern or podium at tradeshows, events or conventions.

MANACOR	QTY	N.W	G.W	C.B.M	SIZE
Packing	1	7.0kg	7.44kg	0.0366	440x130x640mm
10.318	Graphic Size: 1480x1015mm				

## MANACOR



### COUNTER DETAILS



\*Printed on fabric.  
Impression sur toile.  
Impressão em tecido.  
Impresión en tela.



### EXTERNAL SIZE

\*mm

### ARTWORK

### DOWNLOAD

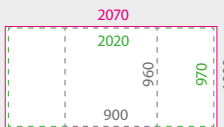
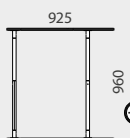

FRONT VIEW SAFE ZONE TOTAL GRAPHIC

### INFORMATION

Mahon is lightweight and easy to assembly. Features the classic raindrop shape design. With carry bag and a double zip to the interior for storing. Ideal as a lectern or podium at promotional events, tradeshows, point of sales.

MAHON	QTY	N.W	G.W	C.B.M	SIZE
Packing	1	10.50kg	10.93kg	0.0672	500x140x960mm
10.319	Graphic Size: 2070x1000mm				

## MAHON



\* Printing is available but not included

# INDOOR FLAG BANNER Indoor Flag Banner



**EN** Indoor Flag Banner. You can choose a flag banner base feet covered with an anti-scratch soft velvet finish. The price includes only the pole.

**FR** Drapeaux d'intérieure disponible en 6 modèles différentes. Possibilité d'être utilisé un socle avec finition anti-rayures . Prix seulement du mât.

**PT** Bandeira para interior disponível em 6 modelos diferentes. A base, vendida por separado, tem um revestimento que evita riscos. Preço do mastro.

**ES** Flag Banner de interior. Puede combinarse con una base antideslizante provista de revestimiento anti-arañazos. El precio incluye sólo el poste.

## ARTWORK \*mm

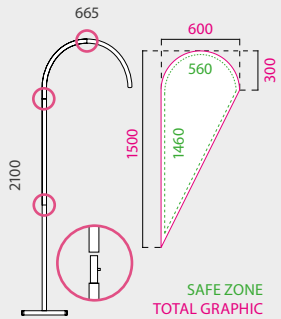

## INFORMATION

- Fast to assemble.
- Carry bag included.
- Suitable with indoor round base.
- Ideal for supermarkets, shops or indoor promotional events.

TEARDROP	QTY	N.W	G.W	C.B.M	SIZE
Packing	1	0.50kg	0.65kg	0.0087	145x60x1000mm
13.621	Graphic: 600x1500mm		Safe: 560x1460mm		

## TEARDROP



## FEATHER

## ARTWORK \*mm

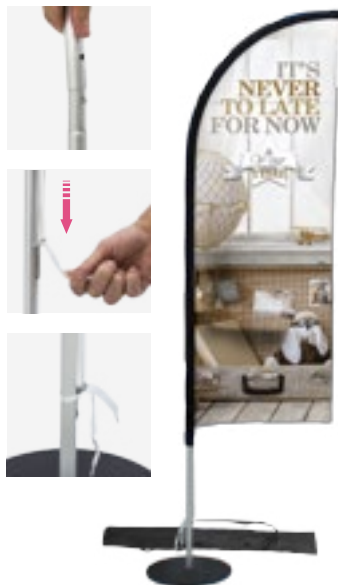
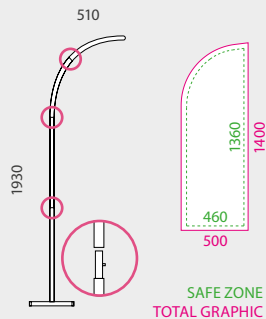

## INFORMATION

- Fast to assemble.
- Carry bag included.
- Suitable with indoor round base.
- Ideal for supermarkets, shops or indoor promotional events.

FEATHER	QTY	N.W	G.W	C.B.M	SIZE
Packing	1	0.40kg	0.55kg	0.0087	145x60x1000mm
13.622	Graphic: 500x1400mm		Safe: 460x1360mm		

## ARTWORK \*mm

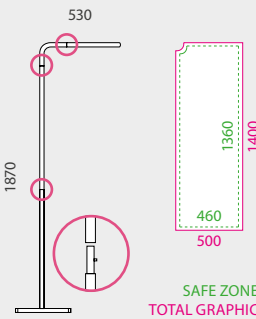

## INFORMATION

- Fast to assemble.
- Carry bag included.
- Suitable with indoor round base.
- Ideal for supermarkets, shops or indoor promotional events.

SQUARED	QTY	N.W	G.W	C.B.M	SIZE
Packing	1	0.40kg	0.55kg	0.0087	145x60x1000mm
13.623	Graphic: 500x1400mm		Safe: 460x1360mm		

\* Price includes only the flagpoles, not the bases.



### SENATOR

#### ARTWORK \*mm

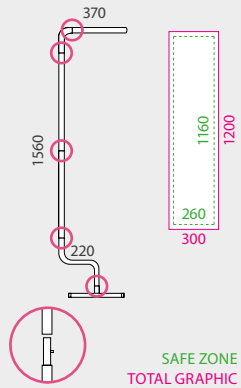

SAFE ZONE  
TOTAL GRAPHIC



with counterweight

#### INFORMATION

- Fast to assemble.
- Counterweight and bag included.
- Suitable with indoor round base.
- Ideal for supermarkets, shops or indoor promotional events.

SENATOR	QTY	N.W	G.W	C.B.M	SIZE
Packing	1	0.45kg	0.60kg	0.0087	145x60x1000mm
13.624	Graphic: 300x1200mm		Safe: 260x1160mm		

### RAZOR

#### ARTWORK \*mm

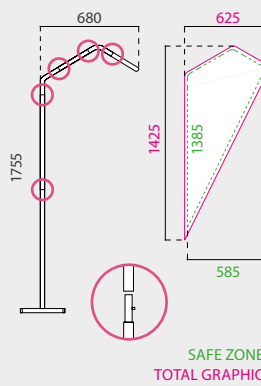

SAFE ZONE  
TOTAL GRAPHIC



#### INFORMATION

- Fast to assemble.
- With carry bag included.
- Suitable with indoor round base.
- Ideal for supermarkets, shops or indoor promotional events.

RAZOR	QTY	N.W	G.W	C.B.M	SIZE
Packing	1	0.45kg	0.60kg	0.0087	145x60x1000mm
13.625	Graphic: 625x1425mm		Safe: 585x1385mm		

### KITE

#### ARTWORK \*mm

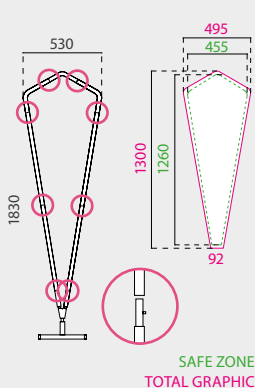

SAFE ZONE  
TOTAL GRAPHIC



indoor round base available

#### INFORMATION

- Fast to assemble.
- Carry bag included.
- Suitable with indoor round base.
- Ideal for supermarkets, shops or indoor promotional events.

KITE	QTY	N.W	G.W	C.B.M	SIZE
Packing	1	0.85kg	1.0kg	0.0087	145x60x1000mm
13.626	Graphic: 495x1300mm		Safe: 455x1260mm		

### INDOOR ROUND BASE

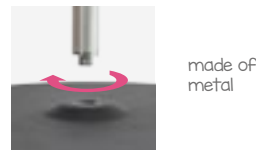

made of metal



2.5mm thickness  
anti-scratch finish



#### INFORMATION

- Made of metal.
- Sided zipped black nylon carry bag with hand-strap included.
- Anti-Scratch finished.

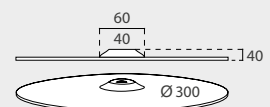

I.ROUND BASE	QTY	N.W	G.W	C.B.M	SIZE
Packing	1	1.10kg	1.20kg	0.00198	315x20x315mm
13.627	Diameter: Ø 300mm				

\* Price includes only the flagpoles, not the bases.

# HANGING SIGNS



## Hanging Signs



EN

The Hanging Signs provide a great visual impact at long distance. With easy-assembly aluminium profiles and high-quality printed graphics where you can expose your message at height. Lightweight and easy to hang from the ceiling by wires. This system comes ready to be used anywhere. Supplied with mounting parts and carry bag.

FR

Les Hanging Signs ont un grand impact visuel. Profils en aluminium, très faciles à monter, et impression de qualité sur toile tendue permettent l'exposition rapide de messages en hauteur. Léger et facile à suspendre, ce système est idéal pour tous les espaces.

PT

Os Hanging Signs transmitem um grande impacto visual. Com perfis de alumínio e de montagem fácil, pode colocar uma mensagem em altura. Leve e fácil de pendurar, este sistema é adequado a qualquer espaço. Fornecido com peças de montagem e saco de transporte.

ES

Los Hanging Signs aportan un gran impacto visual a larga distancia. Con perfiles de aluminio fáciles de montar y una gráfica impresa de alta calidad donde puedes situar un mensaje en altura. Ligeros y fáciles de colgar mediante cables del techo. Este sistema viene preparado para emplearlo en cualquier lugar. Se suministra con piezas de montaje y bolsa de transporte.

## HANGING SIGN SQUARE



easy to hang  
From ceiling by wires

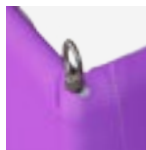
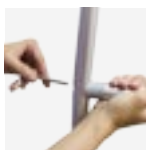
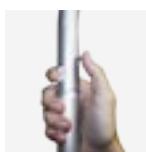

\*Printed on textile.  
Impression sur toile.  
Impressão em tecido.  
Impresión en tela.



### EXTERNAL SIZE

\*mm

REF 15.227

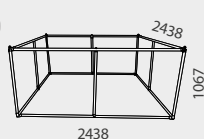

REF 15.228

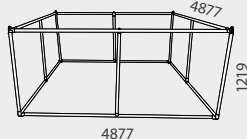

### INFORMATION

This advertising overhead square banner can stand out anywhere. Use this hanging display to gain attention at conventions, even in a large exhibit hall, helping people locate a specific company or booth. Easy to hang from ceiling by wires. This entire display breaks down to fit into one bag for portability. Carry bag is included. The frame pieces easily pop into place for quick setup. Make a lasting impression at a convention with these displays. Two different sizes available.

SQUARE "S"	QTY	N.W	G.W	C.B.M	SIZE
Packing	1	10.5kg	13.6kg	0.1237	370x220x1520mm
15.227		External Size: 2438x1067mm			
SQUARE "M"	QTY	N.W	G.W	C.B.M	SIZE
Packing	1	16.3kg	19.7kg	0.14	370x220x1720mm
15.228		External Size: 4877x1219mm			

\* Custom textile printing in full color is available but not included.





### HANGING SIGN CIRCLE



easy and fast assembly

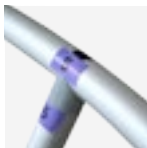

lightweight aluminium profiles

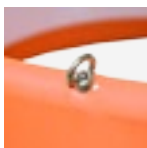

easy to hang from ceiling by wires

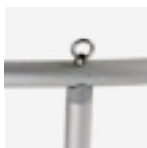

\*Printed on textile.  
Impression sur toile.  
Impressão em tecido.  
Impresión en tela.



#### EXTERNAL SIZE

\*mm

REF 15.229

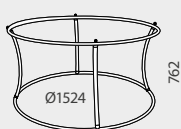

REF 15.230

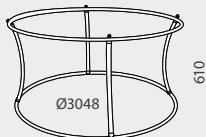

#### INFORMATION

This advertising overhead circular banner can stand out anywhere. Use this hanging display to gain attention at conventions, even in a large exhibit hall, helping people locate a specific company or booth. Easy to hang from ceiling by wires. This entire display breaks down to fit into one bag for portability. Carry bag is included. The frame pieces easily pop into place for quick setup. Make a lasting impression at a convention with these displays. Two different sizes available.

CIRCLE "S"	QTY	N.W	G.W	C.B.M	SIZE
Packing	1	5.5kg	7kg	0.0663	320x170x1220mm
15.229		External Size: 1524x762mm			
CIRCLE "M"	QTY	N.W	G.W	C.B.M	SIZE
Packing	1	16.3kg	19.7kg	0.14	370x220x1720mm
15.230		External Size: 3048x610mm			

\* Custom textile printing in full color is available but not included.



### HANGING SIGN TAPERED CIRCULAR



lightweight  
aluminium profiles

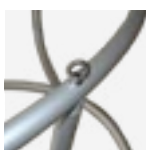
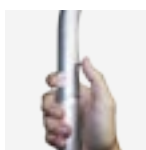

easy to hang from ceiling  
by wires



\*Printed on textile.  
Impression sur toile.  
Impressão em tecido.  
Impresión en tela.

#### EXTERNAL SIZE

\*mm



REF  
15.231



REF  
15.232

#### INFORMATION

This advertising overhead tapered banner can stand out anywhere. Use this hanging display to gain attention at conventions, even in a large exhibit hall, helping people locate a specific company or tradebooth. Easy to hang from ceiling by wires. This entire display breaks down to fit into one bag (included) for portability. The frame pieces easily pop into place for quick setup. Make a lasting impression at a convention with these displays. Two different sizes available.

T. CIRCLE "S"	QTY	N.W	G.W	C.B.M	SIZE
Packing	1	9.8kg	12.9kg	0.14	370x220x1720mm
15.231		External Size: Ø3048/2438x1067mm			
T. CIRCLE "M"	QTY	N.W	G.W	C.B.M	SIZE
Packing	1	12.4kg	15.8kg	0.14	370x220x1720mm
15.232		External Size: Ø4627/3658x1219mm			

\* Custom textile printing in full color is available but not included.

# ROTATING STAND



Rotating Stand

## ROTATING STAND



4m

maximum height of 4m

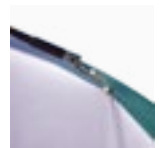

3 plug adapters included

Ø 44mm aluminium pole

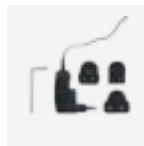

400x400mm steel base



rotating 360° motor



fiberglass sticks



also height can be customized by adding or removing aluminium poles



\*Printed on textile.  
Impression sur toile.  
Impressão em tecido.  
Impresión en tela.

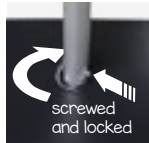
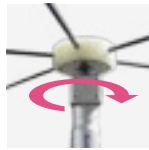

screwed and locked



### EXTERNAL SIZE

### ARTWORK

\*mm

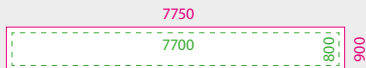
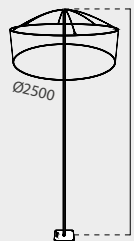

SAFE ZONE  
TOTAL GRAPHIC

### INFORMATION

The Rotating Stand provides a great visual impact at long distance. With easy-assembly aluminium poles and high-quality printed graphics where you can expose your message at height. This system comes ready to be used anywhere. Supplied with steel base, aluminium structure, fiberglass sticks, rotary 360° motor, power supply, plug adapters and carry bag. Use this display to gain attention at conventions or events, helping people locate a specific company or tradebooth.

ROTATING	QTY	N.W	G.W	C.B.M	SIZE
Packing	1	16.3kg	19.7kg	0.14	370x220x1720mm
15.254	Graphic Size: 7750x900mm				

\* Custom textile printing in full color is available but not included.

# DIN SIZES AND DINA FORMATS

A0	841x1189mm
A1	594x841mm
A2	420x594mm
A3	297x420mm

A4	210x297mm
A5	148x210mm
A6	105x148mm
A7	74x105mm

A8	52x74mm
A9	37x52mm
A10	26x37mm

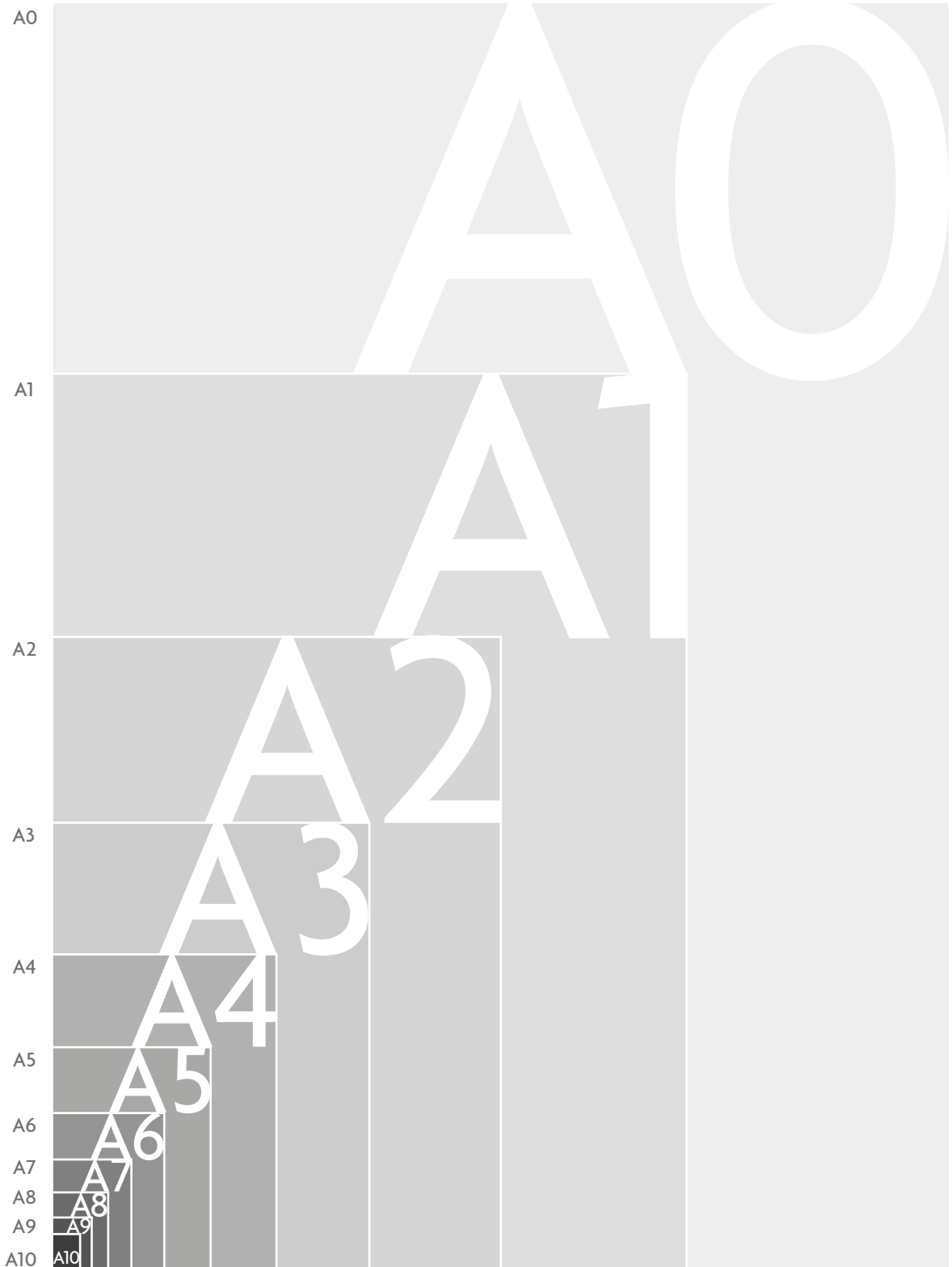



# SIGNAGE 08

Complete range of signage holders for desktops, hanging from wall or ceiling which provide an integral solution for the selling exhibition.

- 348** SIGN HOLDERS
- 376** MOBILE SYSTEM
- 377** POSTER SYSTEM
- 386** DECORAIL
- 387** SIGN SYSTEM
- 393** LED SIGN SYSTEM
- 394** STANDOFF FIXINGS
- 399** PANEL SUPPORT
- 400** OUTDOOR SIGN SYSTEM

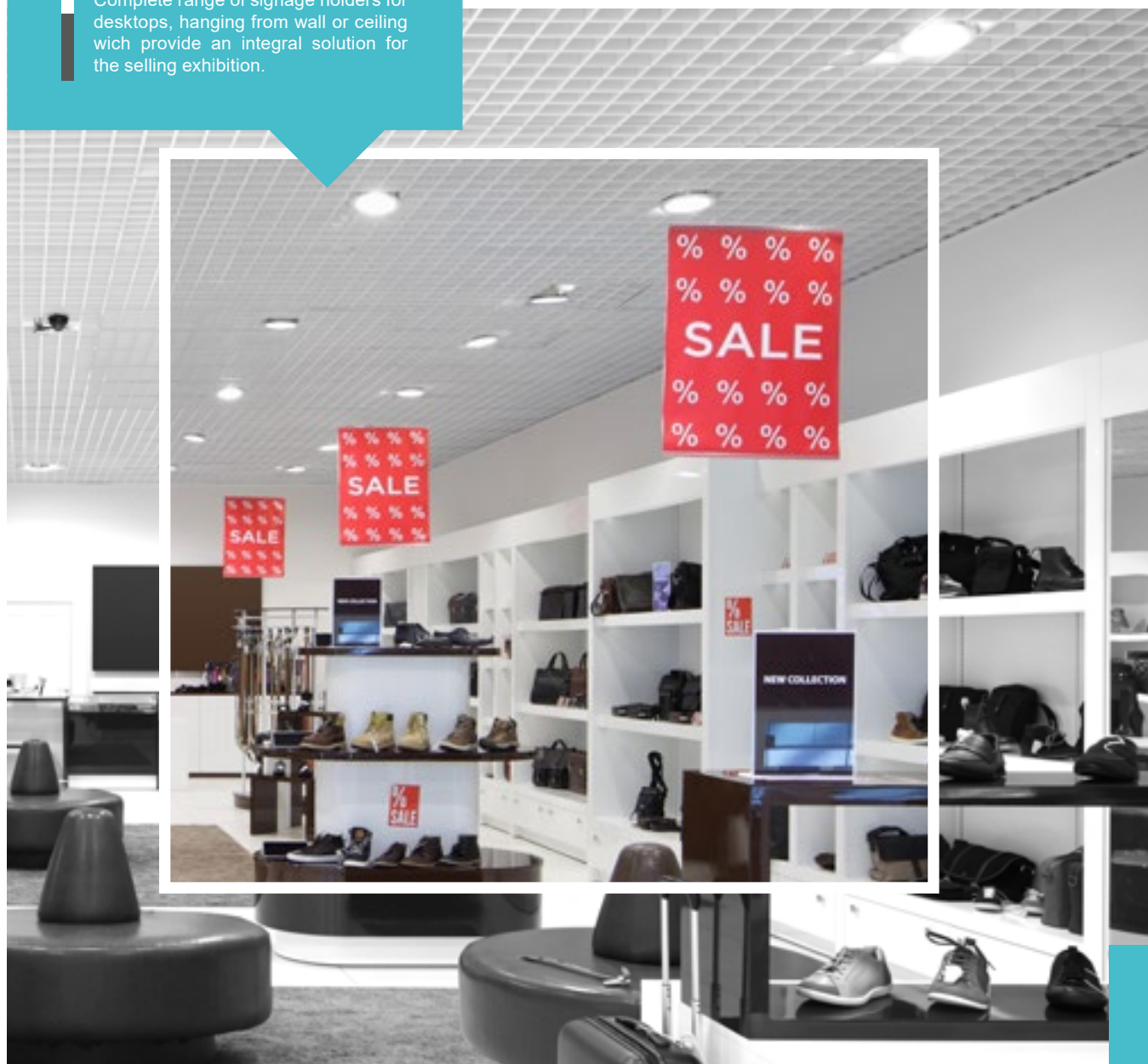

## HOLDER DETAILS

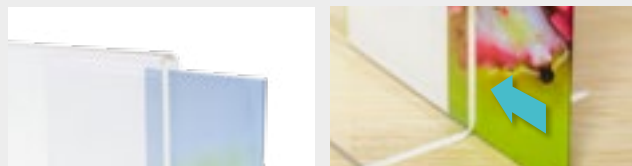



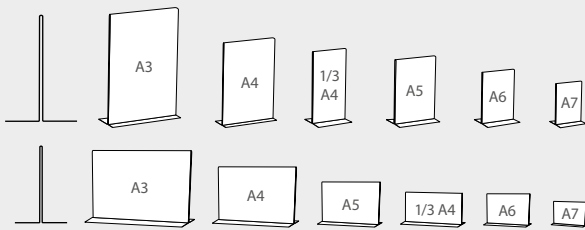

## DIMENSIONS



## INFORMATION

This acrylic sign holder features an inverted "T" shape with portrait or landscape and 6 sizes for each orientation. Our sign holder is designed to hold two standard high sheets of paper back-to-back for double-sided viewing. Paper slips in easily through the bottom and sides. Ideal as marketing tool for a whole range of businesses. Schools, hospitals, real estate offices, coffee menus and retail stores.

"T" OPEN	PORTRAIT	THICKNESS				
13.069P	A3	2mm	x6 			
13.027P	A4	2mm	x10 			
13.028P	A5	2mm	x10 			
13.068P	A6	2mm	x10 			
13.147P	A7	2mm	x10 			
13.148P	1/3 A4	2mm	x10 			

"T" OPEN	LANDSCAPE	THICKNESS				
13.069L	A3	2mm	x6 			
13.027L	A4	2mm	x10 			
13.028L	A5	2mm	x10 			
13.068L	A6	2mm	x10 			
13.147L	A7	2mm	x10 			
13.148L	1/3 A4	2mm	x10 			

## "T" OPEN SIGN HOLDER



## HOLDER DETAILS



## INFORMATION

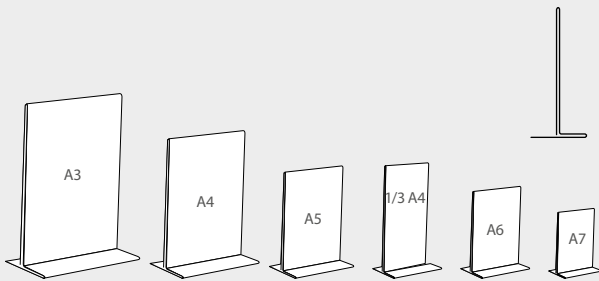

## INFORMATION

This closed acrylic sign holder features an inverted "T" shape with 6 sizes available. Our sign holder is designed to hold two standard high sheets of paper back-to-back for double-sided viewing. Paper slips go in easily through the sides.

"T" CLOSED	PORTRAIT	THICKNESS			
13.000	A3	3mm	x6 		
13.001	A4	2mm	x10 		
13.002	A5	2mm	x10 		
13.003	A6	2mm	x10 		
13.350	A7	2mm	x10 		
13.351	1/3 A4	2mm	x10 		

## "T" CLOSED SIGN HOLDER



## HOLDER DETAILS

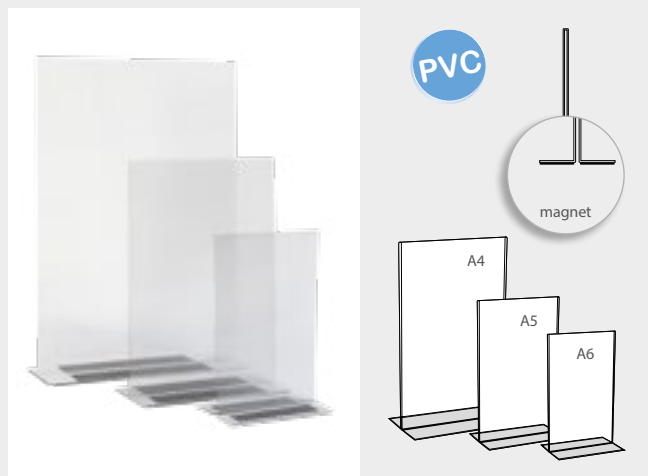

## INFORMATION

This open display is made of PVC and it features an inverted portrait "T" shape with 3 sizes. Also, it has 2 magnetic strips to fix it over metallic surfaces. This is ideal as marketing tool for a whole range of businesses.

"T" MAGNET	PORTRAIT	THICKNESS			
13.046	A4	0.7mm	x10 	  	
13.047	A5	0.7mm	x10 	  	
13.048	A6	0.7mm	x10 	  	

## "T" MAGNET PVC HOLDER



## HOLDER DETAILS

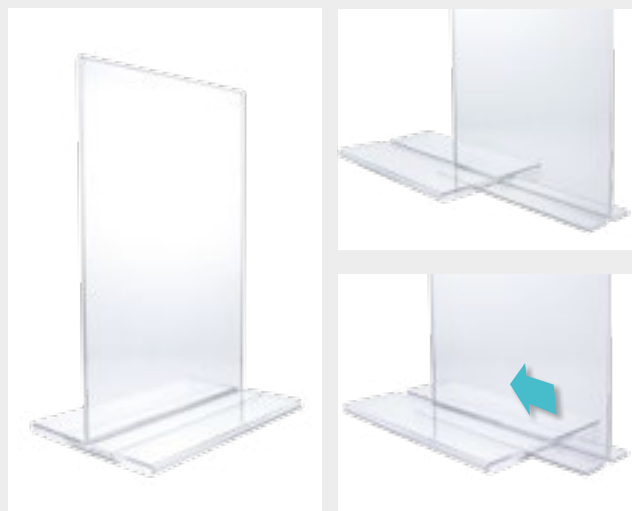

## INFORMATION

This closed transparent Sign Holder has portrait orientation and it features an removable base, which you can take it off to get an easy change of the graphic.

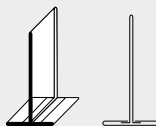

REMOVABLE	FORMAT	THICKNESS			
13.018	A4	2mm	x10 	 	
13.019	A5	2mm	x10 	 	

## REMOVABLE BASE HOLDER









HOLDER DETAILS



INFORMATION

This magnetic display is made of Acrylic and it features an inverted portrait "T" shape with 3 sizes. Also, it has 2 magnetic strips to fix it over metallic surfaces. This is ideal as marketing tool for a whole range of businesses.

"T" MAGNET	PORTRAIT	THICKNESS			
13.841-1	A4	3mm	x5		
13.841-2	A5	3mm	x5		
13.841-3	A6	3mm	x5		

"T" MAGNET HOLDER



HOLDER DETAILS



INFORMATION

This display is made two pieces of 8mm acrylic with four magnets at corners for easy change of graphics. Can be used in portrait or landscape orientation, but landscape mode presents better stability.

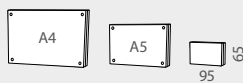

BLOCK MAGNET	PORTRAIT	THICKNESS			
13.843-1	A5	8mm	x6		
13.843-2	A6	8mm	x6		
13.843-3	95x65	8mm	x10		

ACRYLIC MAGNETIC BLOCK



HOLDER DETAILS



DIMENSIONS

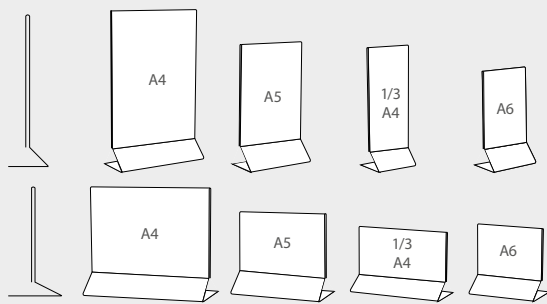

INFORMATION

This acrylic sign holder features a "Z" shape with portrait or landscape and 4 sizes for each orientation. Our sign holder is designed to hold two standard high sheets of paper back-to-back for double-sided viewing. Paper slips in easily through the bottom and sides. Ideal as marketing tool for a whole range of businesses. Schools, hospitals, real estate offices, coffee menus and retail stores.

"Z" OPEN	PORTRAIT	THICKNESS				
13.008P	A4	2mm	x10			
13.009P	A5	2mm	x10			
13.010P	A6	2mm	x10			
13.363P	1/3 A4	2mm	x10			

"Z" OPEN	LANDSCAPE	THICKNESS				
13.008L	A4	2mm	x10			
13.009L	A5	2mm	x10			
13.010L	A6	2mm	x10			
13.363L	1/3 A4	2mm	x10			

"Z" OPEN SIGN HOLDER

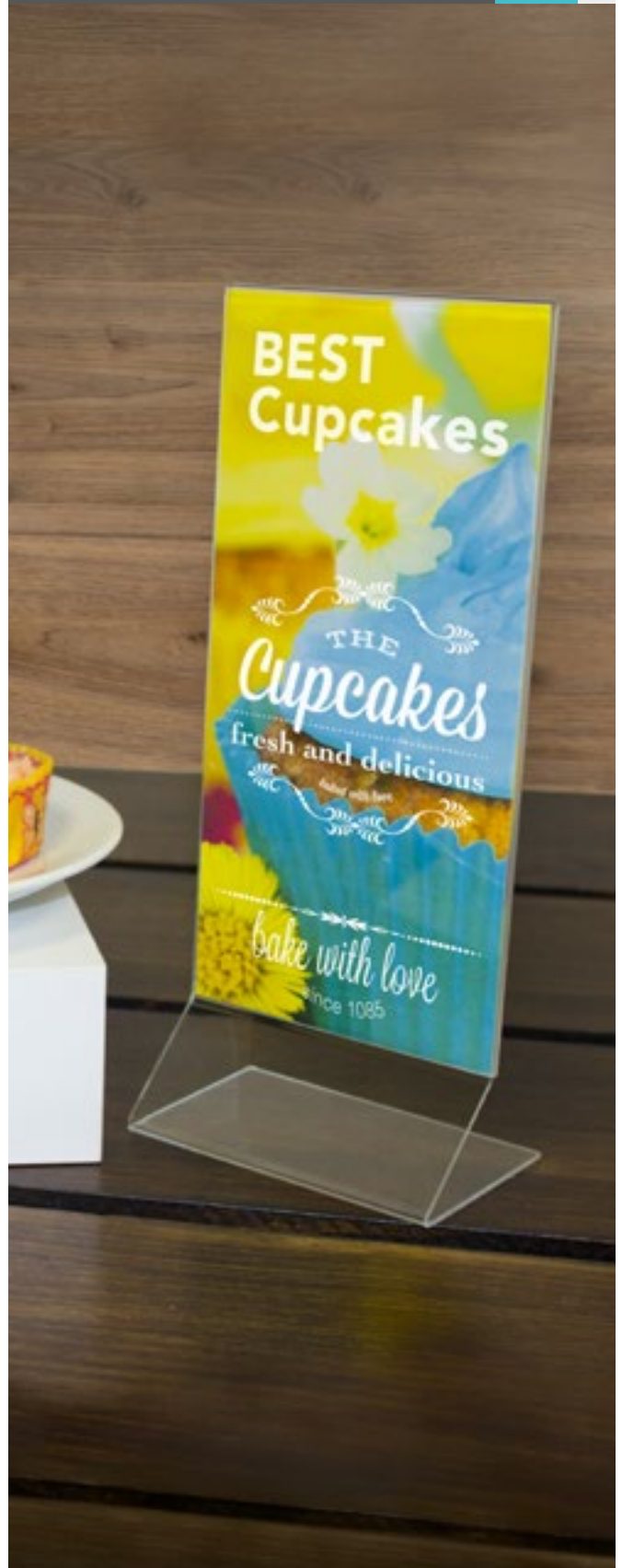

## HOLDER DETAILS

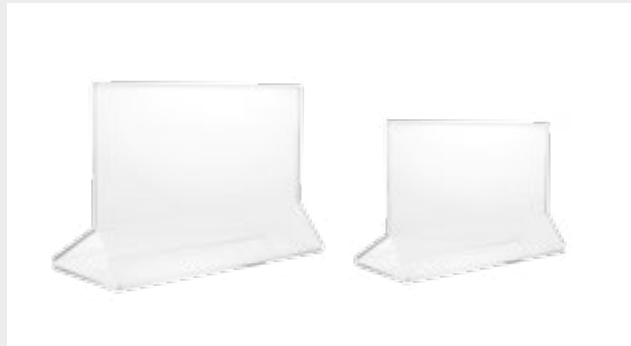

## DIMENSIONS

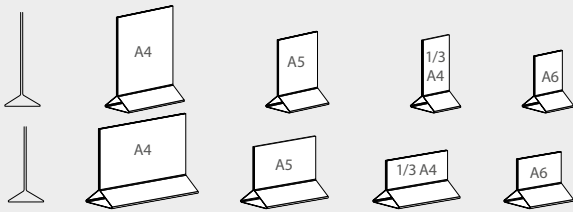

## INFORMATION

This closed Menu Sign Holder with "Snake" shape has landscape and portrait orientation. 4 sizes of each are available. Paper slips in easily through the sides. It is ideal for schools, hospitals, real estate offices, coffee menus or retail stores.

"SNAKE"	PORTRAIT	Thickness				
13.364P	A4	2mm	x10			
13.365P	A5	2mm	x10			
13.366P	A6	2mm	x10			
13.367P	1/3 A4	2mm	x10			

"SNAKE"	LANDSCAPE	Thickness				
13.364L	A4	2mm	x10			
13.365L	A5	2mm	x10			
13.366L	A6	2mm	x10			
13.367L	1/3 A4	2mm	x10			

## "SNAKE" SIGN HOLDER



## HOLDER DETAILS





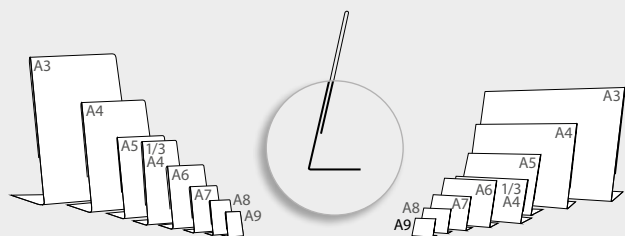



















## DIMENSIONS



## INFORMATION

This acrylic sign holder features an "L" shape with portrait or landscape and 8 sizes for each orientation. Our sign holder is designed to hold two standard high sheets of paper back-to-back for double-sided viewing. Paper slips in easily through the bottom and sides. Ideal as marketing tool for a whole range of businesses. Schools, hospitals, real estate offices, coffee menus and retail stores.

"L" SHAPE	PORTRAIT	THICKNESS				
13.004P	A3	3mm	x5			
13.005P	A4	2mm	x10			
13.006P	A5	2mm	x10			
13.007P	A6	2mm	x10			
13.352P	A7	2mm	x10			
13.353P	A8	2mm	x20			
13.354P	A9	2mm	x20			
13.355P	1/3 A4	2mm	x10			

"L" SHAPE	LANDSCAPE	THICKNESS				
13.004L	A3	3mm	x5			
13.005L	A4	2mm	x10			
13.006L	A5	2mm	x10			
13.007L	A6	2mm	x10			
13.352L	A7	2mm	x10			
13.353L	A8	2mm	x20			
13.354L	A9	2mm	x20			
13.355L	1/3 A4	2mm	x10			

## "L" CLOSED SIGN HOLDER





## HOLDER DETAILS



PVC

## INFORMATION

This open display is made of PVC and it features an "L" shape and 5 sizes with portrait orientation. Ideal as marketing tool for a whole range of businesses such as schools, hospitals, real estates offices, coffee menus or retail stores.

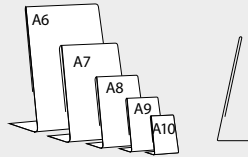

"L" PVC	PORTRAIT	THICKNESS			
13.356P	A6	0.4mm	x50		
13.357P	A7	0.4mm	x50		
13.358P	A8	0.4mm	x50		
13.359P	A9	0.4mm	x50		
13.360P	A10	0.4mm	x50		

## "L" PVC SIGN HOLDER



## INFORMATION

This open display is made of PVC and it features an "L" shape and 5 sizes with portrait orientation. Ideal as marketing tool for a whole range of businesses such as schools, hospitals, real estates offices, coffee menus or retail stores.

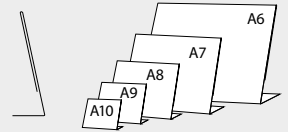

"L" PVC	LANDSCAPE	THICKNESS			
13.356L	A6	0.4mm	x50		
13.357L	A7	0.4mm	x50		
13.358L	A8	0.4mm	x50		
13.359L	A9	0.4mm	x50		
13.360L	A10	0.4mm	x50		

## HOLDER DETAILS



PVC

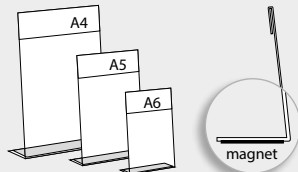

## INFORMATION

This open display is made of PVC and it features an "L" shape with 3 sizes. Also, it has 2 magnetic strips to fix it over metallic surfaces. Ideal as marketing tool.

"L" MAGNET	PORTRAIT	THICKNESS			
13.049	A4	0.7mm	x10		
13.050	A5	0.7mm	x10		
13.051	A6	0.7mm	x10		

## "L" MAGNET PVC HOLDER



HOLDER DETAILS

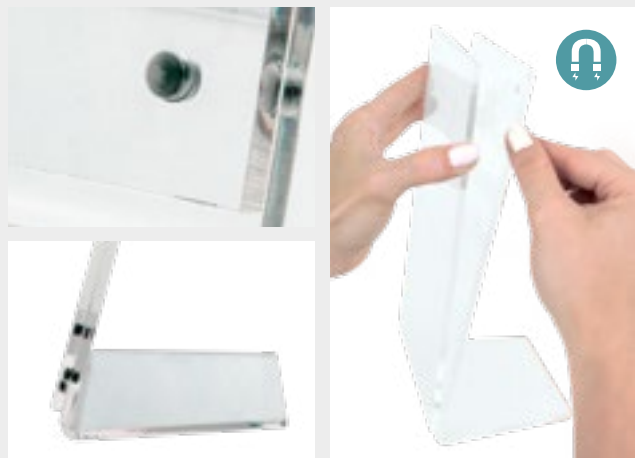

DIMENSIONS

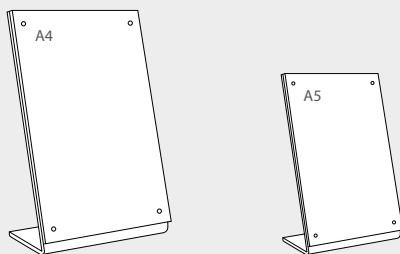

INFORMATION

This acrylic sign holder features an "L" shape with portrait orientation and 2 sizes available. This sign holder features a sandwich with two pieces of 4mm acrylic and 4 magnets at corners for easy change of graphics. Ideal as marketing tool for a whole range of businesses like Schools, hospitals, real estate offices, banks, coffee menus and retail stores.

"L" MAGNET	PORTRAIT	THICKNESS		
13.842-1	A4	4mm	x5 	 
13.842-2	A5	4mm	x5 	 

"L" MAGNETIC HOLDER



## HOLDER DETAILS



## DIMENSIONS

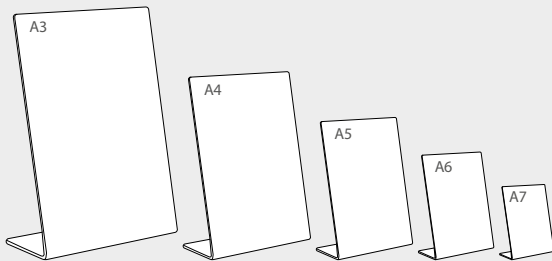

## INFORMATION

This elegant display features an "L" shape with portrait orientation and 5 sizes available. This sign holder is made of 3mm black acrylic with the front face in matt finish and the back in gloss finish. Possibility of sticking a graphic on the front face. Ideal as marketing tool for a whole range of businesses like Schools, hospitals, real estate offices, banks, coffee menus and retail stores.

"L" BLACK	PORTRAIT	THICKNESS			
13.844-1	A3	3mm	x5		
13.844-2	A4	3mm	x10		
13.844-3	A5	3mm	x10		
13.844-4	A6	3mm	x10		
13.844-5	A7	3mm	x10		

## "L" BLACK HOLDER



## HOLDER DETAILS





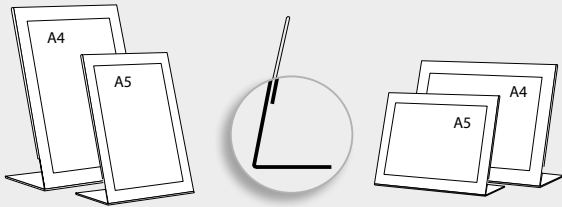



## DIMENSIONS



## INFORMATION

This acrylic sign holder features an "L" shape with portrait or landscape and 2 sizes for each orientation. This Sign Holder features a black frame for a stylish finish and it is designed to hold two standard high sheets of paper back-to-back for double-sided viewing. Paper slips in easily through the bottom and sides. Ideal as marketing tool for a whole range of businesses. Schools, hospitals, real estate offices, banks, coffee menus and retail stores.

BLACK FRAME	PORTRAIT	THICKNESS			
13.361P	A4	2mm	x5 		
13.362P	A5	2mm	x5 		

BLACK FRAME	LANDSCAPE	THICKNESS			
13.361L	A4	2mm	x5 		
13.362L	A5	2mm	x5 		

## "L" BLACK FRAME HOLDER



## HOLDER DETAILS



## DIMENSIONS

\*mm

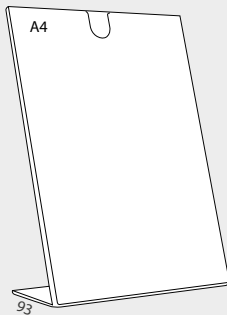

## INFORMATION

This display features an "L" shape with portrait orientation for A4 size documents. This sign holder is made of transparent polystyrene with top loading graphic change. Ideal as marketing tool for a whole range of businesses like Schools, hospitals, real estate offices, banks, coffee menus and retail stores.

## "L" HOLDER WITH OPENING

**new**

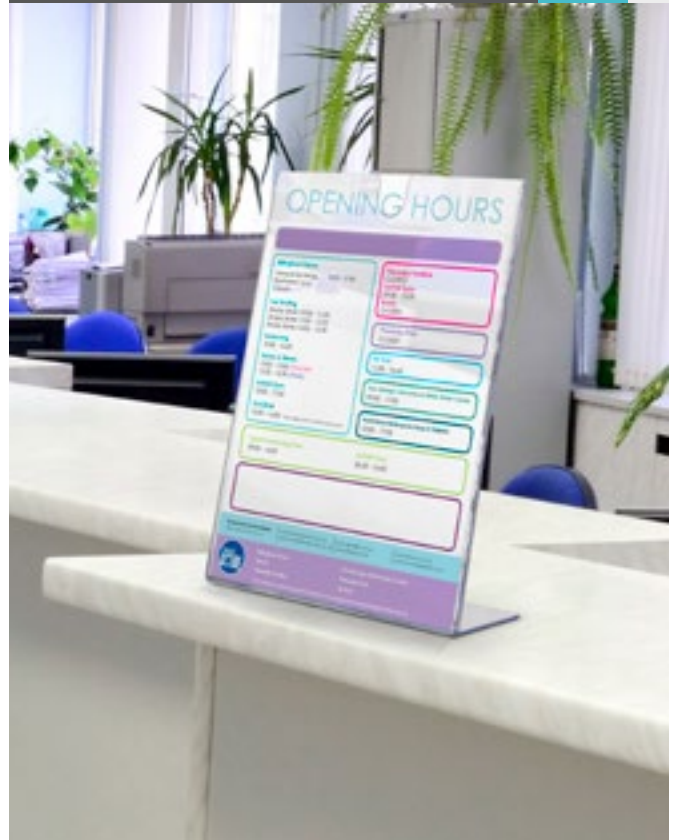

"L" MAGNET    PORTRAIT    THICKNESS

13.835

A4

2mm

x5



HOLDER DETAILS

\*mm

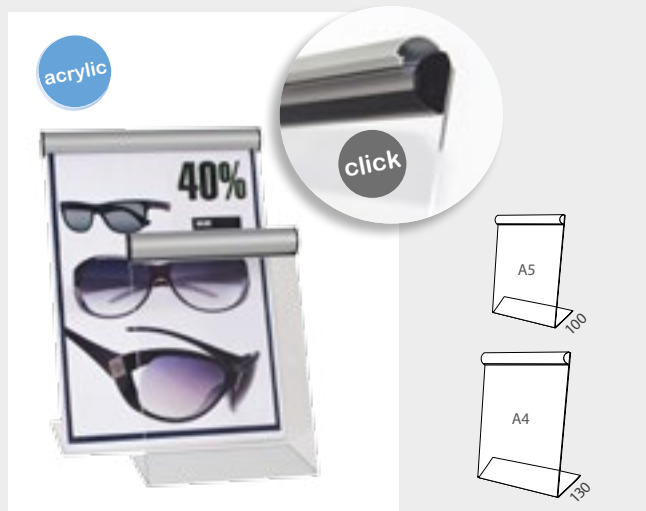

INFORMATION

This closed Sign Holder has an "L" shape and it features a snap top holder to fix the graphics. 2 portrait sizes available. This display is ideal for placing in hotels, schools, and lobby entrance ways for a unique and attention grabbing presentation.

"L" SNAP	PORTRAIT	THICKNESS			
13.384	A4	2mm	x5		
13.385	A5	2mm	x5		

"L" SNAP SIGN HOLDER



HOLDER DETAILS

\*mm



INFORMATION

This closed Sign Holder features an "L" shape and 2 sizes for documents with portrait orientation with a click system to fix the graphics. Two magnetic strips at the base included so it is ideal for placing on shelves or metallic structures at stores for a unique and attention grabbing presentation.

"L" SNAP	PORTRAIT	THICKNESS			
13.016	A4	2mm	x5		
13.017	A5	2mm	x5		

"L" SNAP MAGNET HOLDER



## HOLDER DETAILS



## DIMENSIONS

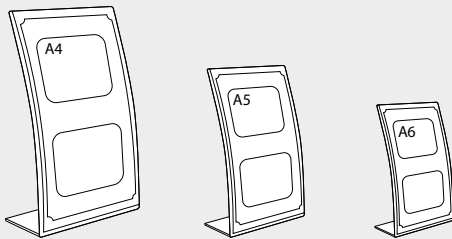

## INFORMATION

This elegant display features an "L" shape with portrait orientation and 3 available sizes. This sign holder is made from strong plastic and is available with white surround. Comes with a non-reflective cover sheet. Ideal as marketing tool for a whole range of businesses like Schools, hospitals, real estate offices, banks, coffee menus and retail stores.

"L" CURVED	PORTRAIT	THICKNESS		
13.840-1	A4	3mm	x10	
13.840-2	A5	3mm	x10	
13.840-3	A6	3mm	x10	

## "L" CURVED HOLDER

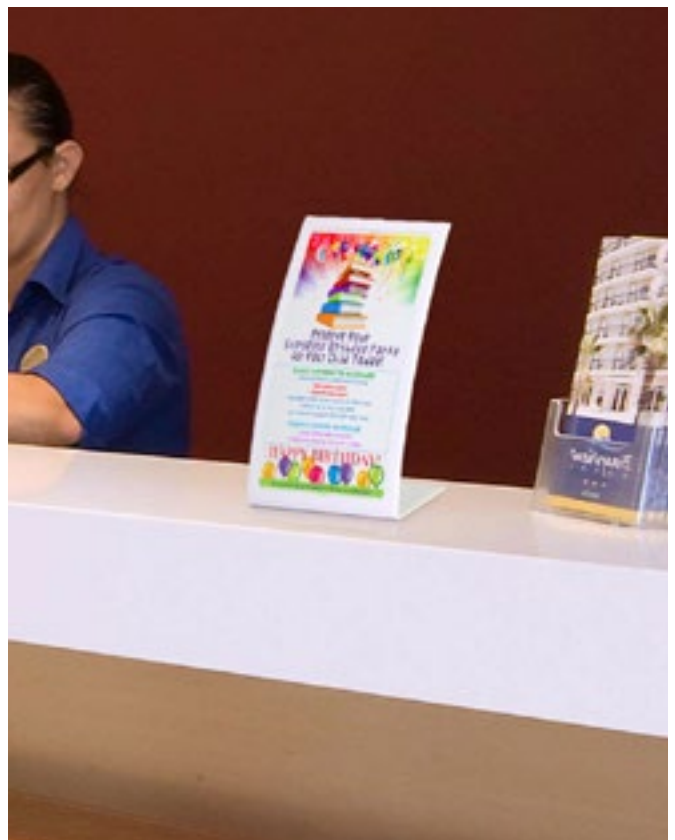

## HOLDER DETAILS



acrylic

## DIMENSIONS \*mm

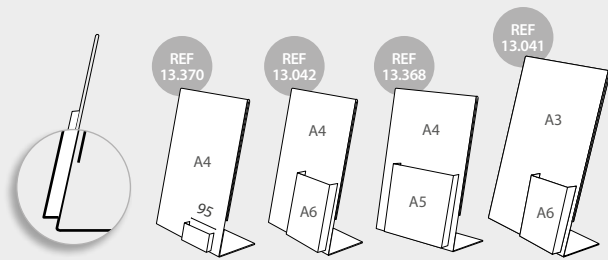













## INFORMATION

This Closed Holder Display features an "L" shape for A4 or A3 format documents with portrait orientation. It features a brochure holders for showcards. Paper slips in easily through the sides. Ideal as marketing tool for a whole range of businesses. Schools, hospitals, real estate offices, banks, coffee menus and retail stores.

## "L" + BROCHURE HOLDER



"L" DISPLAY	SIZE	THICKNESS		*mm
13.370	A4 + Showcard	2 (leaflet 2)	x5   	
13.042	A4 + A6 Leaflet	3 (leaflet 2)	x5   	
13.368	A4 + A5 Leaflet	2 (leaflet 2)	x5   	
13.041	A3 + A6 Leaflet	3 (leaflet 2)	x5   	



## HOLDER DETAILS

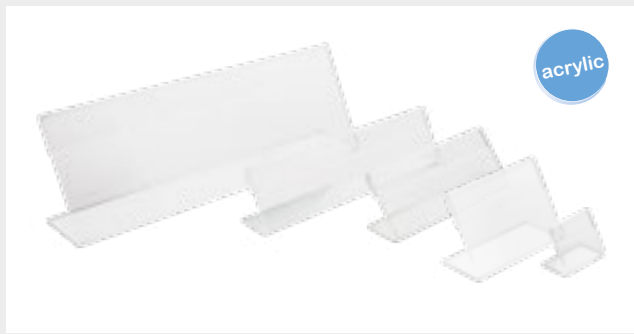

## INFORMATION

\* mm

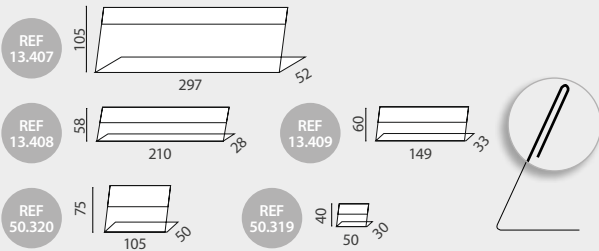

This Desktop Sign Holder has a "L" shape and it is made of 2mm thickness acrylic. 5 sizes available with landscape orientation. Paper slips in easily through the sides.

DESK	SIZE	THICKNESS				
13.407	297x105x52mm	2mm	x10			
13.408	210x58x28mm	2mm	x20			
13.409	149x60x33mm	2mm	x20			
50.320	105x75x50mm	2mm	x20			
50.319	50x40x30mm	2mm	x20			

## DESK ACRYLIC SIGN



## HOLDER DETAILS



## INFORMATION

\*mm

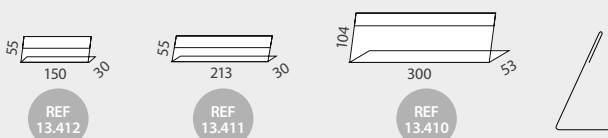

This transparent Desk Sign is made of 0.5mm thickness PVC, featuring 3 models available. It is ideal for displaying ID cards, directory signage or temporary notes.

DESK PVC SIGN	SIZE	THICKNESS			
13.410	300x104x53mm	0.5mm	x20		
13.411	213x55x30mm	0.5mm	x20		
13.412	150x55x30mm	0.5mm	x20		

## DESK PVC SIGN

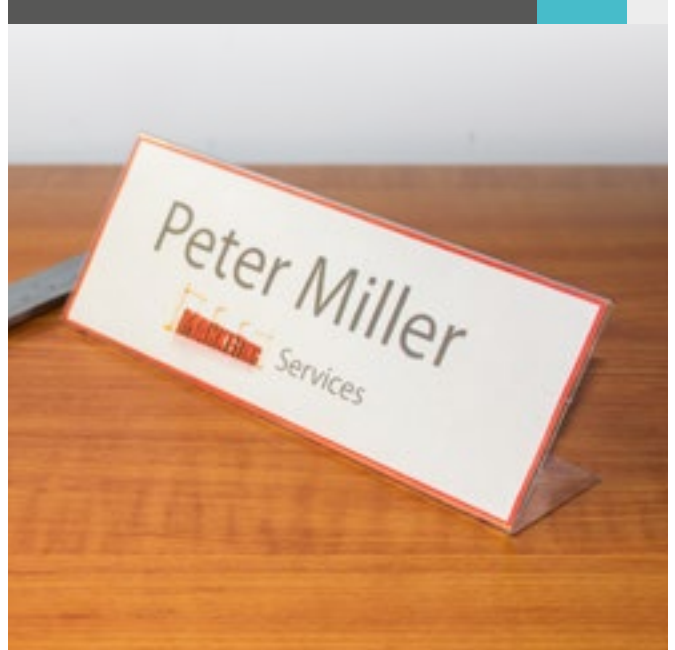

## HOLDER DETAILS



## INFORMATION

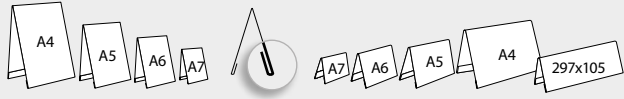

This Sign Holder Display is made of acrylic and has a tent portrait or landscape shape for double-sided viewing. Available in 4 sizes. Paper inserts in easily through the sides.

TENT	SIZE	THICKNESS			
13.029P	A4	2mm	x10		
13.030P	A5	2mm	x10		
13.031P	A6	2mm	x10		
13.032P	A7	2mm	x10		
"L" PVC	LANDSCAPE	THICKNESS			
13.029L	A4	2mm	x10		
13.030L	A5	2mm	x10		
13.031L	A6	2mm	x10		
13.032L	A7	2mm	x10		
13.033L	297x105mm	2mm	x10		

## TENT ACRYLIC DISPLAY



## HOLDER DETAILS



## INFORMATION



This Sign Holder Display is made of PVC and has a tent portrait or landscape shape for double-sided viewing. Available in 4 sizes. Paper inserts in easily through the sides.

TENT PVC	SIZE	THICKNESS			
13.415P	A6	0.4mm	x50		
13.416P	A7	0.4mm	x50		
13.417P	A8	0.4mm	x50		
13.418P	A9	0.4mm	x50		
13.419P	A10	0.4mm	x50		
"L" PVC	LANDSCAPE	THICKNESS			
13.415L	A6	0.4mm	x50		
13.416L	A7	0.4mm	x50		
13.417L	A8	0.4mm	x50		
13.418L	A9	0.4mm	x50		
13.419L	A10	0.4mm	x50		

## TENT PVC DISPLAY



## HOLDER DETAILS



## INFORMATION

\*mm

This acrylic sign Holder with stylish rectangular wooden base is available in 3 sizes (A4, A5 and A6). It is designed for portrait orientation of graphics.

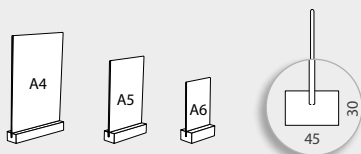

WOOD BASE PORTRAIT THICKNESS

13.011P	A4	2mm	x10				
13.012P	A5	2mm	x10				
13.013P	A6	2mm	x10				

## WOOD BASE HOLDER



## INFORMATION

\*mm

This acrylic sign Holder with stylish rectangular wooden base is available in 3 sizes (A4, A5 and A6). It is designed for portrait orientation of graphics.

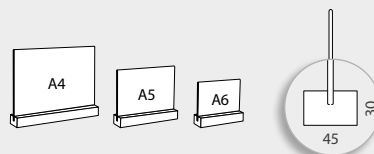

WOOD BASE LANDSCAPE THICKNESS

13.011L	A4	2mm	x10				
13.012L	A5	2mm	x10				
13.013L	A6	2mm	x10				

## HOLDER DETAILS



## INFORMATION

\*mm

This acrylic sign Holder with stylish oval wooden base is available in 3 sizes (A4, A5 and A6). It is designed for portrait orientation of graphics.

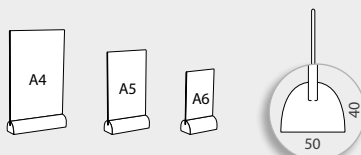

WOOD BASE PORTRAIT THICKNESS

13.391P	A4	2mm	x10				
13.392P	A5	2mm	x10				
13.393P	A6	2mm	x10				

## OVAL WOOD BASE HOLDER



## INFORMATION

\*mm

This acrylic sign Holder with stylish oval wooden base is available in 3 sizes (A4, A5 and A6). It is designed for portrait orientation of graphics.

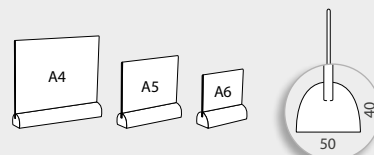

WOOD BASE LANDSCAPE THICKNESS

13.391L	A4	2mm	x10				
13.392L	A5	2mm	x10				
13.393L	A6	2mm	x10				

HOLDER DETAILS



INFORMATION

\* mm

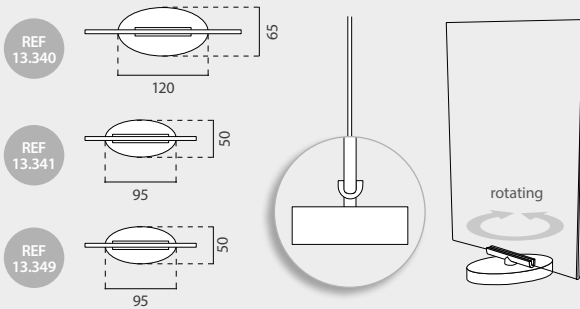

INFORMATION

This open sign frame features transparent panes with green tinted edges, providing the look of real glass. Rotating base with anti-scratch felt bottom pad. Available in 3 sizes with portrait orientation.

"SWIVEL"	PORTRAIT	THICKNESS		
13.340	A4	3mm	x2 	 
13.341	A5	3mm	x4 	 
13.349	1/3 A4	3mm	x4 	 

"SWIVEL"  
LITERATURE HOLDER



## DISPLAY DETAILS



## DIMENSIONS

\*mm

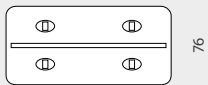

76

- Power/Discharging Indicator
- 1 micro USB input (5V/2.0A)
- 4 USB outputs (5V/2.0A)
- Total Output: 5V / 2.5A
- Capacity: 6.000 mA h
- Charge Time: ± 7-8 h

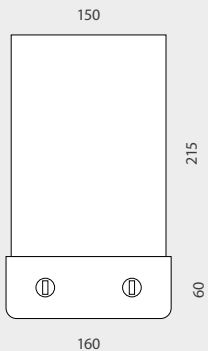

150

215

160

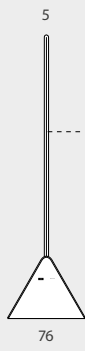

5

inner thickness: 2

76

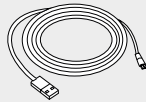

## INFORMATION

This closed sign frame features a transparent acrylic sign holder and a black rubber coating base with 4 usb connectors. It supports charging 4 devices at the same time, so it is ideal for marketing tool and a good choice for the consumers, prolonging their stay in the establishment while they are charging their devices. The portable Powerbank can be charged via DC port or via micro USB. Featuring a Power and Discharging indicator. Also, it is able to charge most electronic devices with a charging voltage of 5.0V. To charge your electronic device, connect the USB output port on the Power Bank to the input port on your device using the provided cable. This Powerbank with unique design is ideal for restaurants, coffee shops, bar, for tea-shops, etc.

POWER BANK

GRAPHICK SIZE

13.572

215x150mm

x1



## POWER BANK DISPLAY

4 USB PORTS



## DIVIDER DETAILS



## DIMENSIONS

\*mm

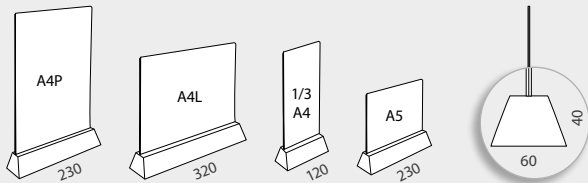

## INFORMATION

This Card Holder features a colored plastic base (3 colors available) with a transparent document holder available in 4 sizes. Ideal as marketing tool for a whole range of businesses such as restaurants, hotels, receptions, waiting rooms or supermarket as checkout divider. Graphic sheet not included.

A5 HOLDER	COLOR	SIZE	
50.134		A5 210x148mm	x10
1/3 A4 HOLDER	COLOR	SIZE	
50.437		1/3 A4 100x210mm	x10
A4 HOLDER	COLOR	SIZE	
50.439		A4 landscape 297x210mm	x10
50.435		A4 portrait 210x297mm	x10

## DIVIDER DETAILS

\*mm

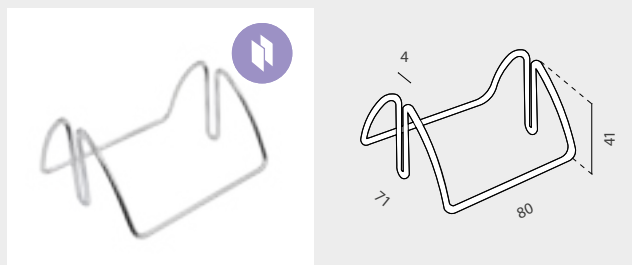

## INFORMATION

This stylish open base is made of 3mm chromed wire. Suitable for different acrylic support sizes with a maximum thickness of 4mm for double sided use. Ideal as desktop marketing tool for a whole range of businesses. Acrylic holder not included.

C.WIRE BASE	QTY	N.W	G.W	C.B.M	SIZE
Packing	1	0.32kg	0.43kg	0.0041	205x125x160 mm
13.574		Size: 80x41x71mm			x12

## BASE DIVIDER



## CHROME WIRE BASE FOR SIGN HOLDERS



\* the graphic customization and acrylic (13.574) at this page are available but not included

## HOLDER DETAILS

\*mm



acrylic

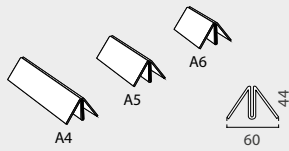

### INFORMATION

This open Card Base has an "M" shape and 3 sizes. Suitable to hold portrait or landscape orientation documents. Paper slips in easily through the top and sides.

"M"	SIZE	THICKNESS			
13.035	210mm/A4	2mm	x10 	 	
13.036	148mm/A5	2mm	x10 	 	
13.037	105mm/A6	2mm	x10 	 	

## "M" ACRYLIC HOLDER



## HOLDER DETAILS

\*mm



acrylic

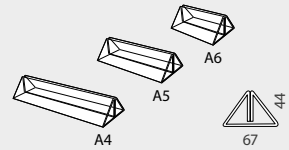

### INFORMATION

This open Base has a "Volcano" shape and 3 sizes. Suitable to hold portrait or landscape orientation documents. Paper slips in easily through the top and sides.

"A"	SIZE	THICKNESS			
13.394	210mm/A4	2mm	x10 	 	
13.395	148mm/A5	2mm	x10 	 	
13.396	105mm/A6	2mm	x10 	 	

## "A" ACRYLIC HOLDER



## HOLDER DETAILS

\*mm

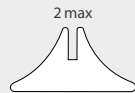

### INFORMATION

This Luxe base made of injected Polystyrene holds A5 portrait sheets. It also allows other sizes in portrait or landscape orientation for 2mm maximum thickness. Paper slips in easily through the top.

LUXE	SIZE	THICKNESS			
13.034	148mm/A5	2mm	x10 	 	

## LUXE BASE HOLDER



## HOLDER DETAILS

\*mm

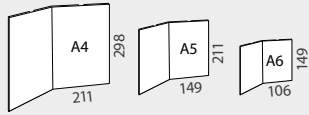

### INFORMATION

This sign holder features a double-portrait shape with double-sided viewing and 3 available sizes. Paper slips through the top and sides.

DUO	SIZE	THICKNESS			
13.283	A4x2	2mm	x5		
13.402	A5x2	2mm	x5		
13.403	A6x2	2mm	x5		

## DUO ACRYLIC HOLDER



## HOLDER DETAILS

\*mm

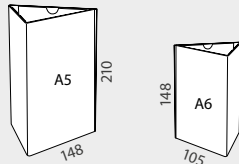

### INFORMATION

This sign holder display features a triangular prism shape with triple-sided viewing and 2 available sizes. Paper slips through the top.

TRIANGLE	SIZE	THICKNESS			
13.386	A5x3	2mm	x4		
13.387	A6x3	2mm	x4		

## TRIANGLE ACRYLIC HOLDER



## HOLDER DETAILS

\*mm

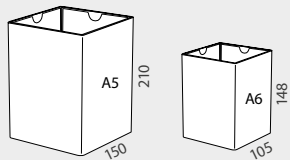

### INFORMATION

This sign holder features a square prism shape with quadruple-sided viewing and 2 available sizes. Paper slips through the top.

SQUARE	SIZE	THICKNESS			
13.388	A5x4	2mm	x4		
13.389	A6x4	2mm	x4		

## SQUARE ACRYLIC HOLDER





## HOLDER DETAILS

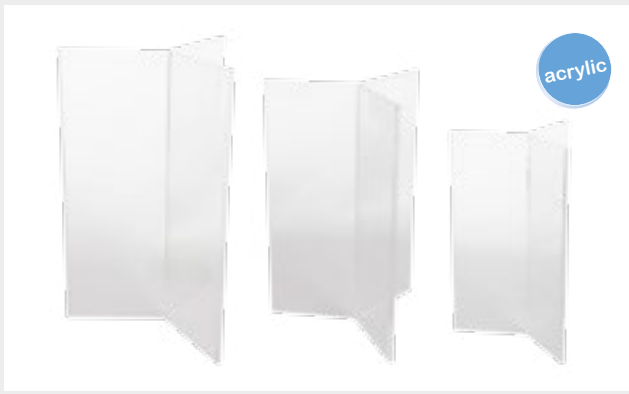

## INFORMATION

\* mm

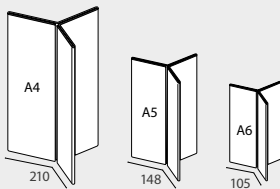

This Sign Holder features a "Y" shape. Available in 3 sizes with portrait orientation. This Sign Holder display is designed for triple-sided viewing. Paper slips through the top. Ideal for restaurants or coffee centers as a menu holder.

"Y"	SIZE	THICKNESS			
13.014	A4x3	2mm	x6		
13.015	A5x3	2mm	x6		
13.390	A6x3	2mm	x6		

## "Y" ACRYLIC HOLDER



## HOLDER DETAILS



## INFORMATION

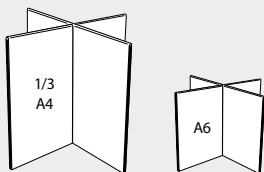

This Sign Holder features a cross shape. 3 sizes available with portrait orientation. This Sign Holder display is designed for quadruple-sided viewing. Paper slips through the top. Ideal for restaurants or coffee centers as a menu holder.

"X"	SIZE	THICKNESS			
13.437	A6	2mm	x5		
13.438	1/3 A4	2mm	x5		

## "X" ACRYLIC HOLDER



HOLDER DETAILS



INFORMATION

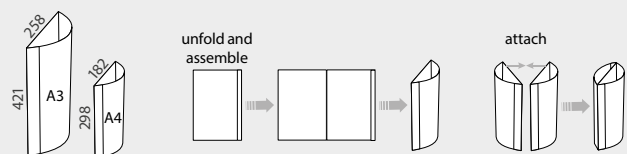

CURVED	SIZE	THICKNESS			
13.420	A3	0.4mm	x10		
13.421	A4	0.4mm	x10		

CURVED PVC DISPLAY



HOLDER DETAILS



INFORMATION

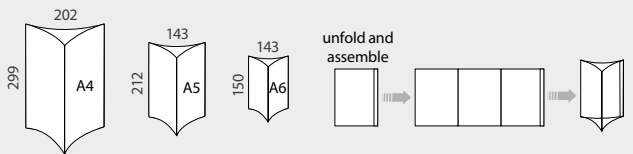

TRIANGLE	SIZE	THICKNESS			
13.422	A4x3	0.4mm	x10		
13.423	A5x3	0.4mm	x10		
13.424	A6x3	0.4mm	x10		

TRIANGLE PVC DISPLAY



## HOLDER DETAILS



## INFORMATION

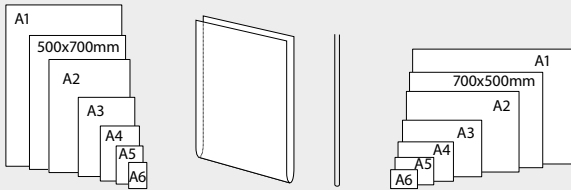

This sign pocket made of acrylic featuring landscape or portrait orientation and 7 available sizes. Suitable for wall mounting or hanging from ceiling for double-sided viewing. Paper slips in easily through the top and sides. Product supplied without holes.

SANDWICH	PORTRAIT	THICKNESS			
13.020P	A1	2mm	x5		
13.021P	A2	2mm	x5		
13.022P	A3	2mm	x5		
13.023P	A4	2mm	x10		
13.024P	A5	2mm	x10		
13.025P	A6	2mm	x10		
13.026P	500x700mm	2mm	x5		
SANDWICH	LANDSCAPE	THICKNESS			
13.020L	A1	2mm	x5		
13.021L	A2	2mm	x5		
13.022L	A3	2mm	x5		
13.023L	A4	2mm	x10		
13.024L	A5	2mm	x10		
13.025L	A6	2mm	x10		
13.026L	500x700mm	2mm	x5		

## ACRYLIC POCKET



## INFORMATION

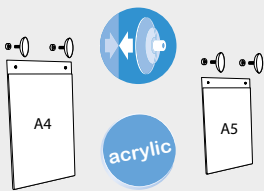

This acrylic Sign Pocket is made of acrylic and it is suitable for fixing on glass or flat surfaces thanks to its suction cups, which are included. Featuring portrait orientation with 2 sizes available. This "Sandwich" Sign Holder is designed for double-sided viewing. Paper slips in easily through the top and sides.

S.C. SANDWICH	SIZE	THICKNESS			
13.376	A4	2mm	x5		
13.397	A5	2mm	x5		

## ACRYLIC POCKET WITH SUCTION CUPS



## HOLDER DETAILS



## DIMENSIONS



## INFORMATION

This sign wall Pocket is made of acrylic. Featuring portrait or landscape orientation with 3 available sizes (A3, A4 and A5 format). This "Sandwich" Pocket has 2 holes at the top for hanging from ceiling or wall mounting. The paper slips in easily through the sides of the pocket.

W.SANDWICH	PORTRAIT	THICKNESS				
13.371P	A3	2mm	x5			
13.372P	A4	2mm	x5			
13.373P	A5	2mm	x5			
W.SANDWICH	LANDSCAPE	THICKNESS				
13.371L	A3	2mm	x5			
13.372L	A4	2mm	x5			
13.373L	A5	2mm	x5			

## ACRYLIC WALL POCKET

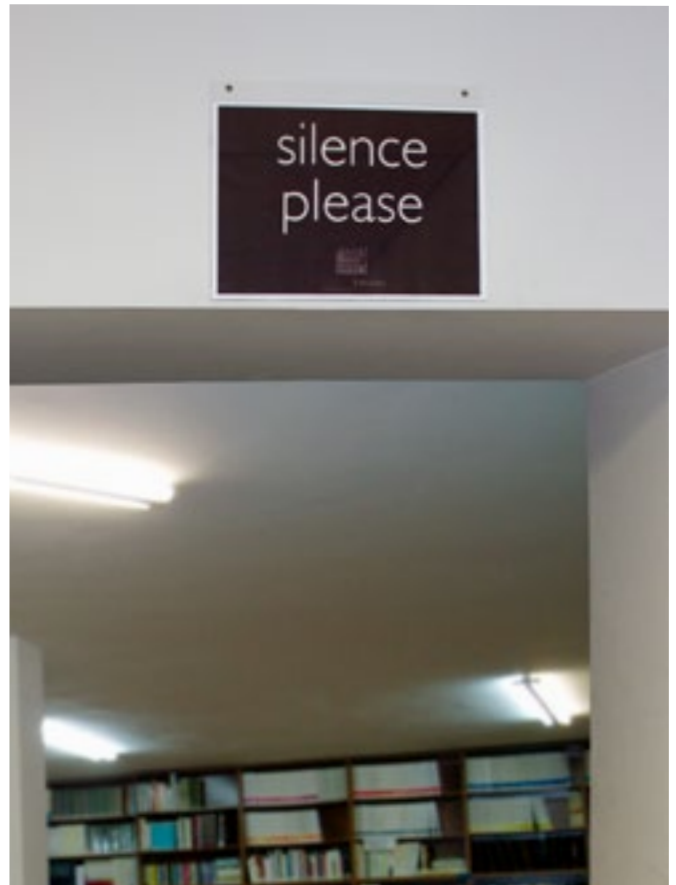

## HOLDER DETAILS

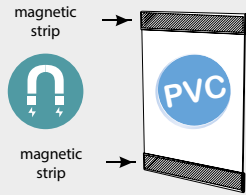

### INFORMATION

This open display features a portrait shape and 7 sizes for documents. Includes 2 magnetic strips at the back side for fixing on metallic surfaces. Paper slips in easily through the sides.

SANDWICH	PORTRAIT	THICKNESS				
13.425	A1	0.5mm	x10			
13.426	A2	0.5mm	x10			
13.052	A3	0.5mm	x10			
13.053	A4	0.5mm	x10			
13.054	A5	0.5mm	x20			
13.055	A6	0.5mm	x20			
13.427	A7	0.5mm	x30			

## MAGNETIC PVC POCKET

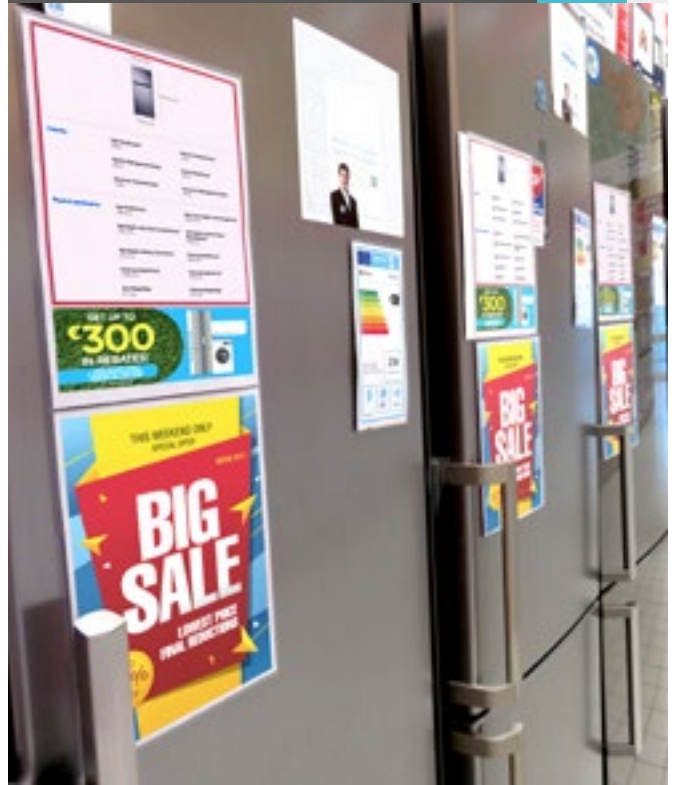

## HOLDER DETAILS

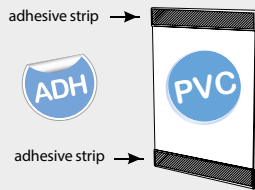

### INFORMATION

This open display features a portrait shape and 7 sizes for documents. Includes 2 adhesive strips at the back side for fixing on different surfaces. Paper slips in easily through the sides.

SANDWICH	PORTRAIT	THICKNESS				
13.428	A1	0.5mm	x10			
13.429	A2	0.5mm	x10			
13.064	A3	0.5mm	x10			
13.065	A4	0.5mm	x10			
13.066	A5	0.5mm	x20			
13.067	A6	0.5mm	x20			
13.430	A7	0.5mm	x30			

## ADHESIVE PVC POCKET



## SMALL TRIARAMA MOBILE KIT

### TRIARAMA DETAIL

### INFORMATION \*mm

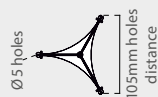
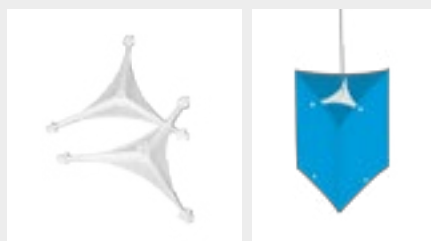

This 3-sided mobile kit has a Graphic size from A4 size up 400mm (200mm minimum size).

### SMALL TRIARAMA

12.067

x2 

## MEDIUM TRIARAMA MOBILE KIT

### TRIARAMA DETAIL

### INFORMATION \*mm

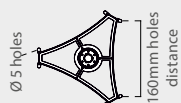
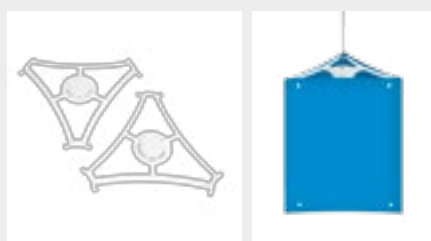

This 3-sided mobile kit has a Graphic size from A4 size up 400mm (200mm minimum size).

### MEDIUM TRIARAMA

12.235

x2 

## BIG TRIARAMA MOBILE KIT

### TRIARAMA DETAIL

### INFORMATION \*mm

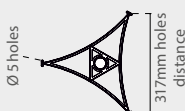
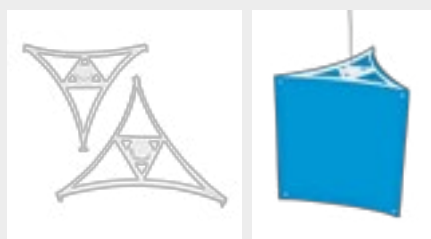

This 3-sided mobile kit has a Graphic size from 400mm up to 750mm (330mm minimum size).

### BIG TRIARAMA

12.234

x2 

## CUADRAMA MOBILE KIT

### QUADRAMA DETAIL

### INFORMATION \*mm

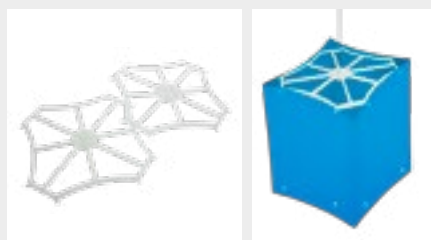

This 4-sided mobile kit has a Graphic size from A4 size up 400mm (200mm minimum size).

### QUADRAMA

12.236

x2 



\* the graphics at this page are available but not included

## PROFILE DETAILS



## INFORMATION

\*mm

CheapClip Kit includes 1 profile and 2 hangers. There are 3 profile lengths and 3 colors to choose from. Its snap-on locking system ensures a firm grip. Ideal for suspending posters to the ceiling or wall.



CHEAP 500	QTY	N.W	G.W	C.B.M	SIZE
Packing	12	0.16kg	0.36kg	0.014	360x80x520mm
10.621	<input type="checkbox"/>	Length: 500mm		x12	
10.622	<input type="checkbox"/>				
10.623	<input checked="" type="checkbox"/>				
CHEAP 800	QTY	N.W	G.W	C.B.M	SIZE
Packing	12	0.28kg	0.48kg	0.023	360x80x820mm
10.624	<input type="checkbox"/>	Length: 800mm		x12	
10.625	<input type="checkbox"/>				
10.626	<input checked="" type="checkbox"/>				
CHEAP 1000	QTY	N.W	G.W	C.B.M	SIZE
Packing	12	0.36kg	0.56kg	0.029	360x80x1020mm
10.627	<input type="checkbox"/>	Length: 1000mm		x12	
10.628	<input type="checkbox"/>				
10.629	<input checked="" type="checkbox"/>				

## CHEAPCLIP



## PROFILE DETAILS



## INFORMATION

\*mm

SoftClip Kit includes 1 profile and 2 hangers. There are 3 profile lengths and 3 colors to choose from. Its snap-on locking system ensures a firm grip. Ideal for suspending posters to the ceiling or wall.

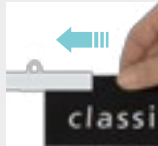

SOFT 500	QTY	N.W	G.W	C.B.M	SIZE
Packing	12	0.28kg	0.4kg	0.014	360x80x520mm
10.612	<input type="checkbox"/>	500mm		x12	
10.613	<input type="checkbox"/>				
10.614	<input checked="" type="checkbox"/>				
SOFT 800	QTY	N.W	G.W	C.B.M	SIZE
Packing	12	0.52kg	0.72kg	0.023	360x80x820mm
10.615	<input type="checkbox"/>	800mm		x12	
10.616	<input type="checkbox"/>				
10.617	<input checked="" type="checkbox"/>				
SOFT 1000	QTY	N.W	G.W	C.B.M	SIZE
Packing	12	0.72kg	0.91kg	0.029	360x80x1020mm
10.618	<input type="checkbox"/>	1000mm		x12	
10.619	<input type="checkbox"/>				
10.620	<input checked="" type="checkbox"/>				

## SOFTCLIP



PROFILE DETAILS





INFORMATION

\*mm

BestClip Kit includes 1 profile and 2 hangers. There are 3 profile lengths and 3 colors to choose from. Its snap-on locking system ensures a firm grip. Ideal for suspending posters to the ceiling or wall.



BEST 500	QTY	N.W	G.W	C.B.M	SIZE
Packing	12	0.4kg	0.6kg	0.014	360x80x520mm
10.603	<input type="checkbox"/>	500mm			x12 
10.604	<input type="checkbox"/>				
10.605	<input checked="" type="checkbox"/>				
BEST 800	QTY	N.W	G.W	C.B.M	SIZE
Packing	12	0.64kg	0.84kg	0.023	360x80x820mm
10.606	<input type="checkbox"/>	800mm			x12 
10.607	<input type="checkbox"/>				
10.608	<input checked="" type="checkbox"/>				
BEST 1000	QTY	N.W	G.W	C.B.M	SIZE
Packing	12	0.72kg	0.92kg	0.029	360x80x1020mm
10.609	<input type="checkbox"/>	1000mm			x12 
10.610	<input type="checkbox"/>				
10.611	<input checked="" type="checkbox"/>				

BESTCLIP



PROFILE DETAILS



INFORMATION

\*mm

StrongClip Kit includes 1 profile and 2 hangers. There are 3 profile lengths and 3 colors to choose from. Its snap-on locking system ensures a firm grip. Ideal for suspending posters to the ceiling or wall.



STRONG 500	QTY	N.W	G.W	C.B.M	SIZE
Packing	12	0.52kg	0.72kg	0.029	360x160x520mm
10.630	<input type="checkbox"/>	500mm			x12 
10.631	<input type="checkbox"/>				
10.632	<input checked="" type="checkbox"/>				
STRONG 800	QTY	N.W	G.W	C.B.M	SIZE
Packing	12	1kg	1.2kg	0.035	270x160x820mm
10.633	<input type="checkbox"/>	800mm			x12 
10.634	<input type="checkbox"/>				
10.635	<input checked="" type="checkbox"/>				
STRONG1000	QTY	N.W	G.W	C.B.M	SIZE
Packing	12	1.2kg	1.4kg	0.044	270x160x1020mm
10.636	<input type="checkbox"/>	1000mm			x12 
10.637	<input type="checkbox"/>				
10.638	<input checked="" type="checkbox"/>				

STRONGCLIP





PROFILE DETAILS

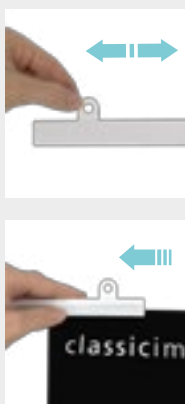

KIT INCLUDES

PROFILE \*mm

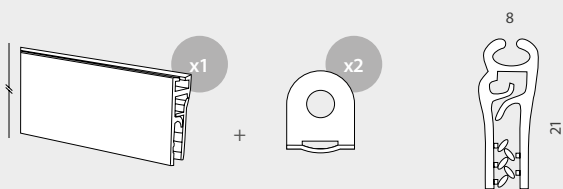

INFORMATION

PlastiClip Kit includes: 2 upper hooks (which are adjustable along the top rail) and 1 poster profile with snap-on locking system which ensures a firm grip. Also, PlastiClip features 5 profile lengths and 2 colors available. Ideal for suspending posters, "banner" promotions, special offers or prices to the ceiling over the products at the supermarkets or malls.

PLASTI 440	QTY	N.W	G.W	C.B.M	SIZE
Packing	12	0.48kg	0.68kg	0.004	130x90x440mm
10.526	<input type="checkbox"/>	440mm		x12	
10.527	<input checked="" type="checkbox"/>				
PLASTI 500	QTY	N.W	G.W	C.B.M	SIZE
Packing	12	0.6kg	0.8kg	0.005	130x90x500mm
10.528	<input type="checkbox"/>	500mm		x12	
10.529	<input checked="" type="checkbox"/>				
PLASTI 600	QTY	N.W	G.W	C.B.M	SIZE
Packing	12	0.72kg	0.92kg	0.007	360x90x600mm
10.530	<input type="checkbox"/>	600mm		x12	
10.531	<input checked="" type="checkbox"/>				
PLASTI 800	QTY	N.W	G.W	C.B.M	SIZE
Packing	12	0.88kg	1.05kg	0.009	130x90x800mm
10.532	<input type="checkbox"/>	800mm		x12	
10.533	<input checked="" type="checkbox"/>				
PLASTI 1000	QTY	N.W	G.W	C.B.M	SIZE
Packing	12	1.08kg	1.2kg	0.01	130x90x1000mm
10.534	<input type="checkbox"/>	1000mm		x12	
10.535	<input checked="" type="checkbox"/>				

PLASTICLIP



## PROFILE DETAILS

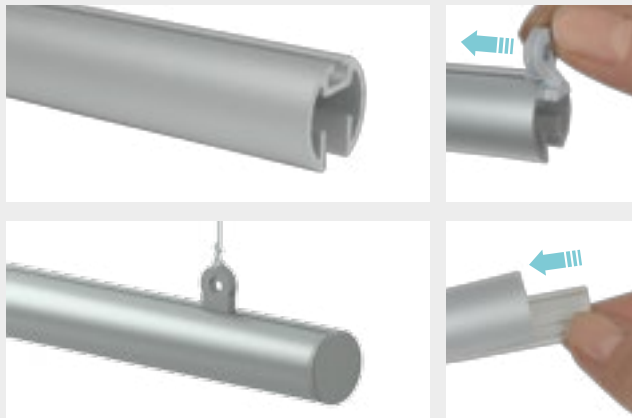

## KIT INCLUDES

PROFILE \*mm

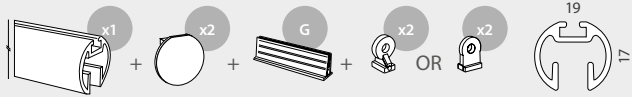

## INFORMATION

AluGrip Kit features 4 profile lengths and 2 different hangers to choose. Its gripper system ensures a firm grip. Ideal for suspending posters to the ceiling or wall.

ALUGRIP 300	QTY	N.W	G.W	C.B.M	SIZE
Packing	4	0.31kg	0.5kg	0.0008	50x45x340mm
10.172	300mm	2 Grippers (G)		x4	
ALUGRIP 500	QTY	N.W	G.W	C.B.M	SIZE
Packing	4	0.51kg	0.7kg	0.0012	50x45x540mm
10.173	500mm	3 Grippers (G)		x4	
ALUGRIP 700	QTY	N.W	G.W	C.B.M	SIZE
Packing	4	0.7kg	0.85kg	0.0017	50x45x740mm
10.174	700mm	4 Grippers (G)		x4	
ALUGRIP 1000	QTY	N.W	G.W	C.B.M	SIZE
Packing	4	1kg	1.4kg	0.0023	50x45x1040mm
10.175	1000mm	5 Grippers (G)		x4	

## GRIPPERS FOR ALUGRIP

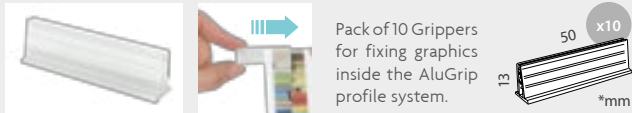

ALU GRIPPERS	QTY	N.W	G.W	C.B.M	SIZE
Packing	10	0.025kg	0.03kg	0.0005	75x75x90mm
10.176	50mm			x10	

## ENDCAPS FOR ALUGRIP



ALU ENDCAPS	QTY	N.W	G.W	C.B.M	SIZE
Packing	10	0.007kg	0.008kg	0.0005	75x75x90mm
10.177				x10	

## ALUGRIP

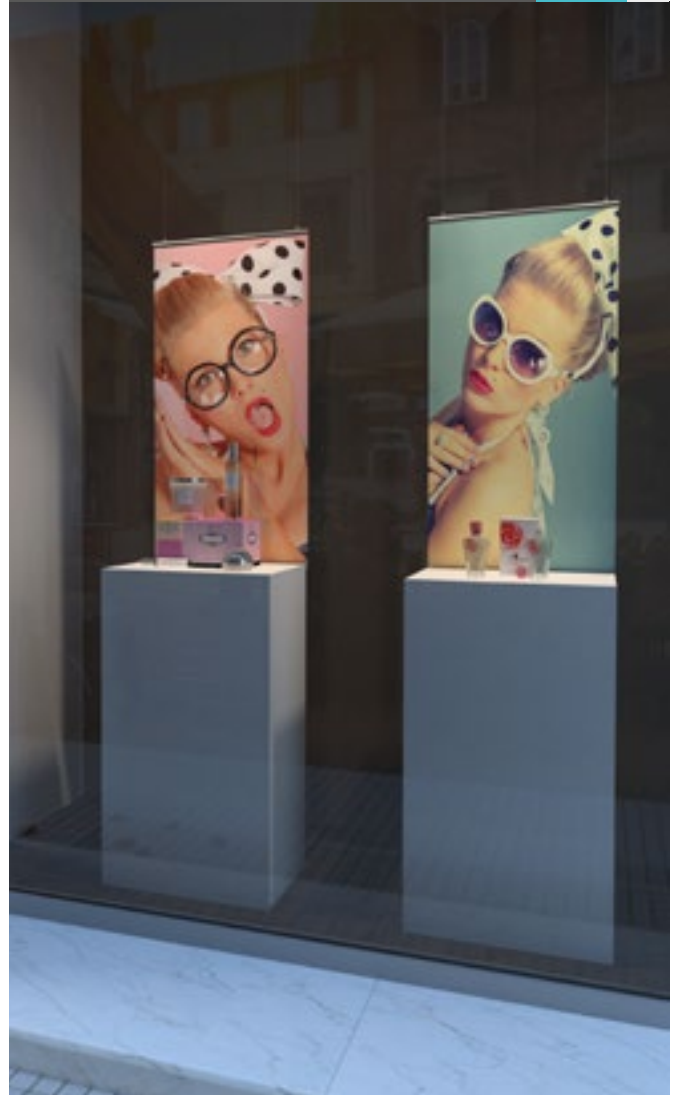

## SIDEVIEW HANGERS FOR ALUGRIP

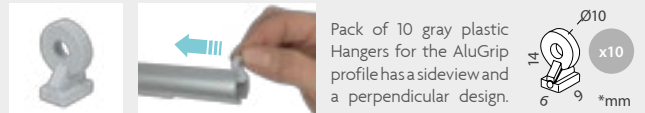

ALU HANGERS	QTY	N.W	G.W	C.B.M	SIZE
Packing	10	0.005kg	0.005kg	0.0005	75x75x90mm
10.178				x10	

## FRONTVIEW HANGERS FOR ALUGRIP

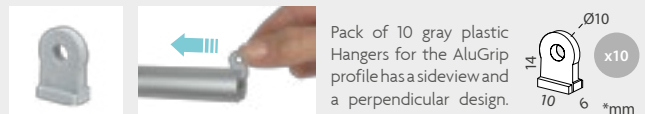

ALU HANGERS	QTY	N.W	G.W	C.B.M	SIZE
Packing	10	0.006kg	0.01kg	0.00004	65x10x65mm
10.179				x10	

PROFILE DETAILS



KIT INCLUDES

PROFILE \*mm



INFORMATION

AluPoster features 6 profile lengths. Its click locking system profile ensures a firm grip for the graphic. Ideal for suspending posters to the ceiling or wall.

ALUPOSTER 300	QTY	N.W	G.W	C.B.M	SIZE
Packing	4	0.4kg	0.6kg	0.0014	80x60x310mm
10.086		300mm		x4	
ALUPOSTER 500	QTY	N.W	G.W	C.B.M	SIZE
Packing	4	0.72kg	0.92kg	0.0024	80x60x510mm
10.087		500mm		x4	
ALUPOSTER 800	QTY	N.W	G.W	C.B.M	SIZE
Packing	4	1.12kg	1.32kg	0.0038	80x60x810mm
10.088		800mm		x4	
ALUPOSTER 1000	QTY	N.W	G.W	C.B.M	SIZE
Packing	4	1.48kg	1.68kg	0.0048	80x60x1010mm
10.089		1000mm		x4	
ALUPOSTER 1200	QTY	N.W	G.W	C.B.M	SIZE
Packing	4	1.68kg	1.88kg	0.0058	80x60x1210mm
10.090		1200mm		x4	
ALUPOSTER 1500	QTY	N.W	G.W	C.B.M	SIZE
Packing	4	2kg	2.2kg	0.0072	80x60x1510mm
10.091		1500mm		x4	

ENDCAPS FOR ALUPOSTER



Pack of 10 grey plastic Endcaps for completing this profile. Ideal for changing the overall look of the Aluposter System.

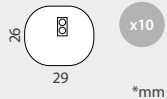

P.ENDCAP	QTY	N.W	G.W	C.B.M	SIZE
Packing	1	0.009kg	0.02kg	0.00004	65x10x65mm
13.399		x10			

ALUPOSTER



RING CLIP FOR ALUPOSTER



Pack of 10 grey plastic Hanger Ring Clips for suspending the AluPoster profile. Ideal for being used with Nylon Roll.

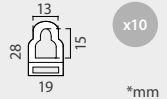

RING CLIP	QTY	N.W	G.W	C.B.M	SIZE
Packing	1	0.047kg	0.01kg	0.00004	65x10x65mm
13.400		x10			

PROFILE DETAILS









KIT INCLUDES

PROFILE \*mm



INFORMATION

The AluClip features 6 profile lengths. Its clic locking system ensures a firm grip for the graphic. Ideal for suspending posters to the ceiling or the wall.

ALUCLIP 300	QTY	N.W	G.W	C.B.M	SIZE
Packing	4	0.35kg	0.5kg	0.0009	65x40x320mm
10.080			300mm	x4	
ALUCLIP 500	QTY	N.W	G.W	C.B.M	SIZE
Packing	4	0.57kg	0.8kg	0.0014	65x40x540mm
10.081			500mm	x4	
ALUCLIP 800	QTY	N.W	G.W	C.B.M	SIZE
Packing	4	0.9kg	1.2kg	0.0022	65x40x840mm
10.082			800mm	x4	
ALUCLIP 1000	QTY	N.W	G.W	C.B.M	SIZE
Packing	4	1.2kg	1.5kg	0.0027	65x40x1040mm
10.083			1000mm	x4	
ALUCLIP 1200	QTY	N.W	G.W	C.B.M	SIZE
Packing	4	1.4kg	1.8kg	0.0032	65x40x1240mm
10.084			1200mm	x4	
ALUCLIP 1500	QTY	N.W	G.W	C.B.M	SIZE
Packing	4	1.7kg	2.2kg	0.004	65x40x1540mm
10.085			1500mm	x4	

ENDCAPS FOR ALUCLIP



A Pack of 10 black plastic Endcaps is ideal for completing the AluClip profile.

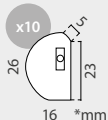

P. ENDCAP	QTY	N.W	G.W	C.B.M	SIZE
Packing	1	0.009kg	0.02kg	0.00004	65x10x65mm
13.398			x10		

ALUCLIP



RING CLIP FOR ALUCLIP



This Pack of 10 plastic Hanger Ring Clip for suspending the Aluclip profile system is ideal for changing the look of the Aluclip Profile System.

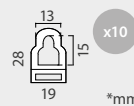

RING CLIP	QTY	N.W	G.W	C.B.M	SIZE
Packing	1	0.047kg	0.01kg	0.00004	65x10x65mm
13.400			x10		

## PROFILE DETAILS



## KIT INCLUDES

PROFILE \*mm



## INFORMATION

Alulon features 6 profile lengths. Its snap-on locking system ensures a firm grip for the graphic. Ideal for suspending posters to the ceiling or the wall.

ALULON 500	QTY	N.W	G.W	C.B.M	SIZE
Packing	4	1.2kg	1.4kg	0.0017	540x90x35mm
10.571		500mm		x4	
ALULON 800	QTY	N.W	G.W	C.B.M	SIZE
Packing	4	1.8kg	2.1kg	0.0026	90x35x840mm
10.191		800mm		x4	
ALULON 1000	QTY	N.W	G.W	C.B.M	SIZE
Packing	4	2.2kg	2.6kg	0.0033	90x35x1040mm
10.572		1000mm		x4	
ALULON 1200	QTY	N.W	G.W	C.B.M	SIZE
Packing	4	2.7kg	3kg	0.0039	90x35x1240mm
10.193		1200mm		x4	
ALULON 1500	QTY	N.W	G.W	C.B.M	SIZE
Packing	4	3.4kg	3.8kg	0.0049	90x35x1540mm
10.194		1500mm		x4	
ALULON 3000	QTY	N.W	G.W	C.B.M	SIZE
Packing	4	6.5kg	7.4kg	0.0123	90x45x3025mm
10.195		3000mm		x4	

## ENDCAPS FOR ALULON



A Pack of 10 black plastic Endcaps is ideal for completing the Alulon profile.



ENDCAP	QTY	N.W	G.W	C.B.M	SIZE
Packing	1	0.009kg	0.02kg	0.00004	65x10x65mm
10.196		x10			

## ALULON



## RING CLIP FOR ALULON



A Pack of 10 plastic Hanger Ring Clip. It is ideal for suspending the Alulon System profile.



H.RING CLIP	QTY	N.W	G.W	C.B.M	SIZE
Packing	1	0.047kg	0.01kg	0.00004	65x10x65mm
10.197		x10			

PROFILE DETAILS



KIT INCLUDES

PROFILE \*mm





INFORMATION

The FastClip System Kit includes: 2 upper grey plastic hangers (which are adjustable along the top rail), 2 grey plastic endcaps and 1 aluminium profile with a pack of retainers which ensures a firm grip for the poster or graphic. Also, FastClip features 6 aluminium profile lengths available. Ideal for suspending posters, "banner" promotions, special offers or prices to the ceiling over the products at retail stores or the supermarkets.

FASTCLIP 300	QTY	N.W	G.W	C.B.M	SIZE
Packing	4	0.65kg	0.8kg	0.0018	340x90x60mm
50.600	300mm	5 Retainers (R)		x4	

FASTCLIP 500	QTY	N.W	G.W	C.B.M	SIZE
Packing	4	1.17kg	1.4kg	0.0029	540x90x60mm
50.601	500mm	9 Retainers (R)		x4	

FASTCLIP 800	QTY	N.W	G.W	C.B.M	SIZE
Packing	4	1.7kg	2kg	0.0045	840x90x60mm
50.602	800mm	15 Retainers (R)		x4	

FASTCLIP 1000	QTY	N.W	G.W	C.B.M	SIZE
Packing	4	2kg	2.45kg	0.0056	90x60x1040mm
50.603	1000mm	19 Retainers (R)		x4	

FASTCLIP 1200	QTY	N.W	G.W	C.B.M	SIZE
Packing	4	2.4kg	2.9kg	0.0067	90x60x1240mm
50.604	1200mm	24 Retainers (R)		x4	

FASTCLIP 1500	QTY	N.W	G.W	C.B.M	SIZE
Packing	4	2.9kg	3.5kg	0.0083	90x60x1540mm
50.605	1500mm	30 Retainers (R)		x4	

FASTCLIP



PROFILE DETAILS









KIT INCLUDES

PROFILE \*mm



INFORMATION

The Semi Circular FastClip Kit includes: 2 upper hooks (which are adjustable along the top rail), 2 plastic endcaps, 1 poster profile with an adhesive strip on their back face and a pack of retainers which ensures a firm grip. Also, Semi Circular FastClip features 6 profile lengths available. Ideal for suspending posters, "banner" promotions, special offers or prices to the ceiling over the products at the supermarkets or retails stores.

SEMI C.F.300	QTY	N.W	G.W	C.B.M	SIZE
Packing	4	0.45kg	0.6kg	0.0015	340x100x45mm
50.606	300mm		5 Retainers (R)	x4	
SEMI C.F.500	QTY	N.W	G.W	C.B.M	SIZE
Packing	4	0.7kg	1kg	0.0024	100x45x1040mm
50.607	500mm		9 Retainers (R)	x4	
SEMI C.F.800	QTY	N.W	G.W	C.B.M	SIZE
Packing	4	1kg	1.4kg	0.0038	100x45x840mm
50.608	800mm		15 Retainers (R)	x4	
SEMI C.F.1000	QTY	N.W	G.W	C.B.M	SIZE
Packing	4	1.3kg	1.8kg	0.0047	100x45x1040mm
50.609	1000mm		19 Retainers (R)	x4	
SEMI C.F.1200	QTY	N.W	G.W	C.B.M	SIZE
Packing	4	1.5kg	2.1kg	0.0056	100x45x1250mm
50.610	1200mm		24 Retainers (R)	x4	
SEMI C.F.1500	QTY	N.W	G.W	C.B.M	SIZE
Packing	4	1.95kg	2.5kg	0.0069	100x45x1540mm
50.611	1500mm		30 Retainers (R)	x4	

SEMI CIRCULAR FASTCLIP



# POSTER SYSTEM Decorail

The Decorail is a profile system composed by an aluminium profile in which they can anchor **multiple advertising systems**. Ideal for **islands** and **supermarket modules**.

## DECORAIL

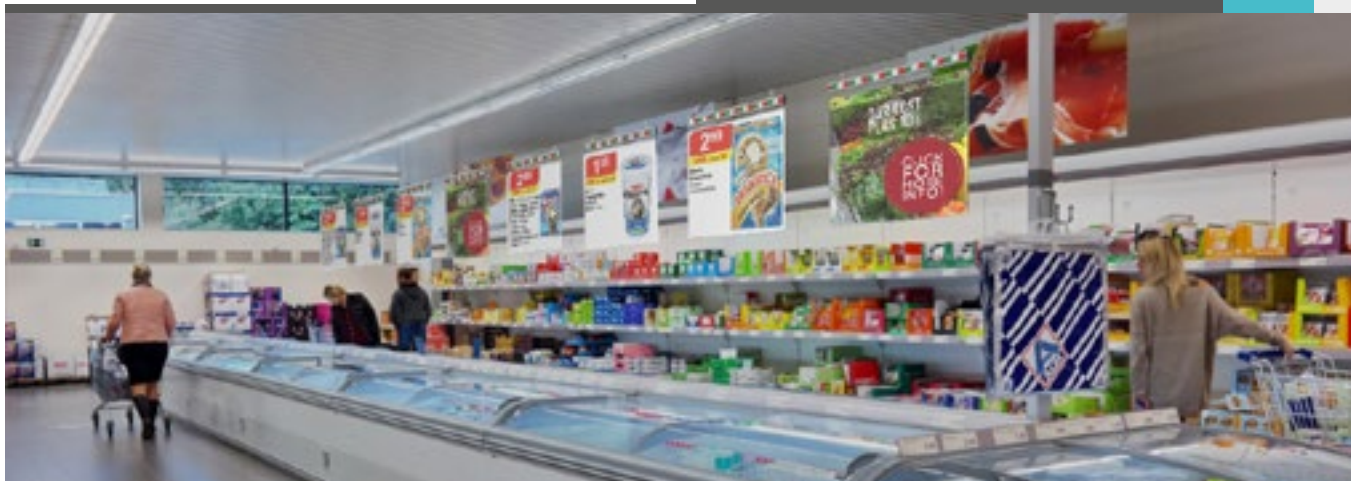

### ALUMINIUM PROFILE FOR DECORAIL

#### PROFILE DETAILS



#### INFORMATION

\*mm

The Decorail 47 mm high aluminium profile offers the optional opportunity to customize the inside front with a graphic. Ideal for promoting offers, products as priceholders, suspending signage over products, increasing their visibility in supermarket sections.



PROFILE	QTY	N.W	G.W	C.B.M	SIZE
Packing	4	6.5kg	7.4kg	0.0123	90x45x3025mm
50.620	3000mm		x4 		

### ENDCAP FOR DECORAIL

#### ENDCAP DETAILS



#### INFORMATION

\*mm

This pack of 10 Endcaps is made of plastic with a grey finish. They avoid the extraction of the profile graphic. With a simple insertion, they are ideal for completing the Decorail Profile Kit.

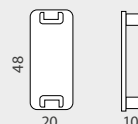

ENDCAP	QTY	N.W	G.W	C.B.M	SIZE
Packing	1	0.009kg	0.02kg	0.0004	65x10x65mm
50.622			x10 		

### HANGER RING CLIP FOR DECORAIL

#### HANGER DETAILS



#### INFORMATION

\*mm

This pack of 10 Hangers are made of plastic with a grey finish. They allow the hanging and side shift of the profile. Featuring 3 different diameters for suspending. With a simple insertion, they are ideal for completing the Decorail Profile.

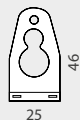

HANGER RING	QTY	N.W	G.W	C.B.M	SIZE
Packing	10	0.047kg	0.01kg	0.00004	65x10x65mm
10.197			x10 		

### CLIP HANGER FOR DECORAIL

#### CLIP DETAILS



#### INFORMATION

\*mm

This pack of 10 Clips Hangers is made of plastic. They allow the suspension and side shift of signage and promotional posters. With a simple side insertion, they are ideal for completing the Decorail Profile Kit.

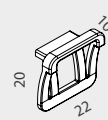

HANGER CLIP	QTY	N.W	G.W	C.B.M	SIZE
Packing	1	0.009kg	0.02kg	0.0004	65x10x65mm
50.623			x10 		



## SIGN SYSTEM CONTENT

EN	Standard signage system for indoor use. Straight aluminium profile. Recommended materials: digital printing and vinyl cutting. Supplied in complete kits. Graphic and screws not included.
FR	Système de signalisation composé d'un profil en aluminium droit. Matières recommandées: papier photographique, vinyle de coupe, etc. Vendus en jeux complets. Visuel et vis non incluses.
PT	Sinalização de interior com perfil recto. Materiais recomendados: Papel fotográfico, vinil de recorte, etc. Kit completo. Impressão e parafusos de fixação não incluídos.
ES	Sistema de señalización estándar para uso interior. Perfilera de aluminio recta. Materiales recomendados: impresión digital y vinilo de corte. Kits completos. Gráfica y tornillería no incluidas.

## SIGN SYSTEM DETAILS



two straight profiles



## INFORMATION

## PROFILE SIZE

\*mm

- Straight profile
- Plastic pieces for fixing
- Aluminium plate
- Plastic endcaps

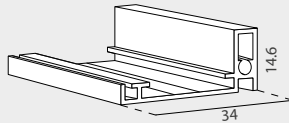

## “BARGELLO” STRAIGHT



## INSTALLING EXPLANATION

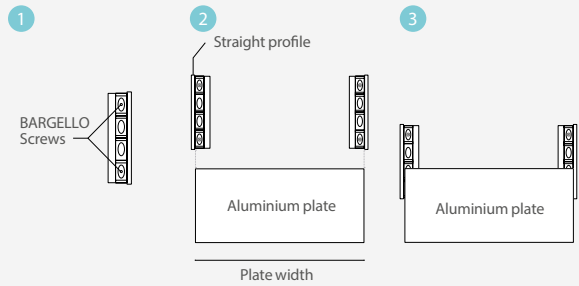

Possibility of fixing with double sided tape. Continue with the next steps if you wish to screw it to the wall:

1. Make two holes in the side profiles, as shown.
2. Screw the profiles to the wall, adjusting the width of the plate.
3. Fix the central plate by pressing on the side covers.

BARGELLO	SIZE	
15.634	120x60mm	
15.635	220x60mm	
15.636	300x60mm	
15.637	150x90mm	
15.638	220x90mm	
15.639	300x90mm	
15.668	124x120mm	
15.640	150x124mm	
15.641	220x124mm	
15.642	300x124mm	

BARGELLO	SIZE	
15.670	150x150mm	
15.643	220x150mm	
15.644	300x150mm	
15.645	400x150mm	
15.672	180x180mm	
15.646	500x60mm	
15.647	500x90mm	
15.648	500x124mm	
15.649	500x150mm	
15.650	500x180mm	

## SIGN SYSTEM CONTENT

EN	Standard signage system for indoor use. Curved aluminium profile. Recommended materials: digital printing and vinyl cutting. Supplied in complete kits. Graphic and screws not included.
FR	Système de signalisation composé d'un profil en aluminium courbé. Matières recommandées: papier photographique, vinyle de coupe, etc. Vendus en jeux complets. Visuel et vis non incluses.
PT	Sinalização de interior com perfil curvo. Materiais recomendados: Papel fotográfico, vinil de recorte, etc. Kit completo. Impressão e parafusos de fixação não incluídos.
ES	Sistema de señalización estándar para uso interior. Perfilera de aluminio curva. Materiales recomendados: impresión digital y vinilo de corte. Kits completos. Gráfica y tornillería no incluidas.

## SIGN SYSTEM DETAILS

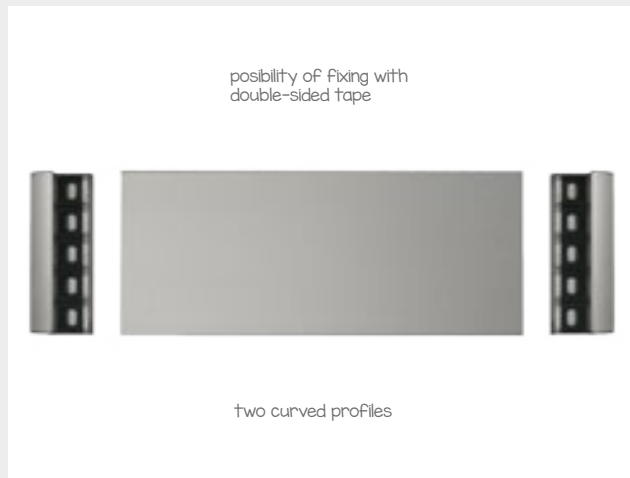

## INFORMATION PROFILE SIZE \*mm

- Curved profile
- Plastic pieces for fixing
- Aluminium plate
- Plastic endcaps

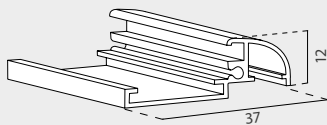

## “ORSAY” CURVED

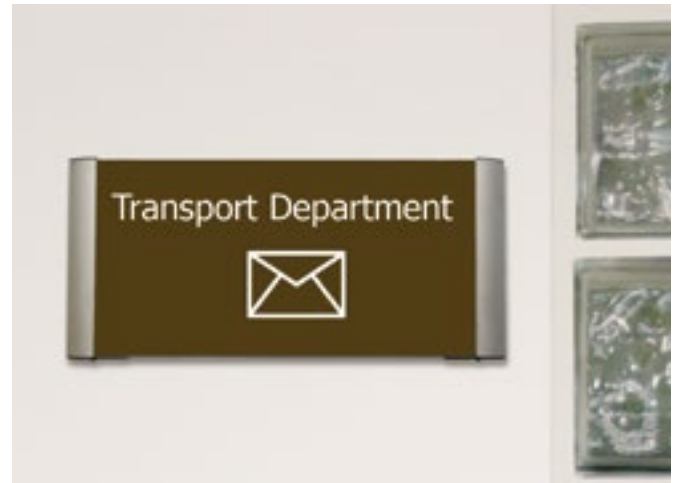

## INSTALLING EXPLANATION

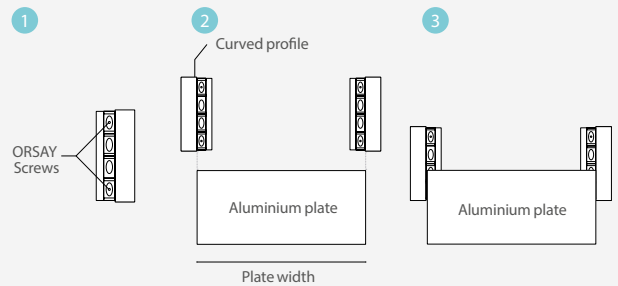

Possibility of fixing with double sided tape. Continue with the next steps if you wish to screw it to the wall:

1. Make two holes in the side profiles, as shown.
2. Screw the profiles to the wall, adjusting the width of the plate.
3. Fix the central plate by pressing on the side covers.

ORSAY	SIZE
15.651	120x60mm
15.652	220x60mm
15.653	300x60mm
15.654	150x90mm
15.655	220x90mm
15.656	300x90mm
15.657	150x124mm
15.658	220x124mm
15.659	300x124mm

ORSAY	SIZE
15.660	220x150mm
15.661	300x150mm
15.662	400x150mm
15.663	500x60mm
15.664	500x90mm
15.665	500x124mm
15.666	500x150mm
15.667	500x180mm

## SIGN SYSTEM CONTENT

EN

Signaling system composed by curved aluminum plates and side covers. Available in 3 different widths. This system allows the composition of curved wall directories according to customer needs. The components of this system are supplied separately.

FR

Système de signalisation avec profil d'aluminium courbé et bouchons latéraux. Disponible en 3 hauteurs différentes. Ce système permet la création de panneaux directionnels en fonction des besoins de clients. Les éléments de ce système sont vendus séparément.

PT

Perfil curvo de alumínio com tampas laterais para a criação de placas de sinalização. Está disponível em 3 alturas diferentes. Este sistema permite a construção de placas de sinalização mediante as necessidades do cliente. Os componentes deste sistema são vendidos por separado.

ES

Sistema de señalización compuesto por placas de aluminio curvas y tapas laterales. Disponible en 3 anchos distintos. Este sistema permite la composición de directorios de pared curvos según la necesidad del cliente. Los componentes de este sistema se suministran por separado.

## “BEYELER” CURVED SIGN SYSTEM

Includes plastic protector



### EXTERNAL SIZES

\*mm



### PROFILE (PRICE FOR LINEAR METER)

HEIGHT

10.224	60mm
10.225	90mm
10.226	140mm













### PROFILE CUT

10.233	Unit cutting
--------	--------------

### PLASTIC ENDCAPS

COLOR

HEIGHT

10.227		60mm	x10 
10.230		60mm	x10 
10.228		90mm	x10 
10.231		90mm	x10 
10.229		140mm	x10 
10.232		140mm	x10 



## “VICENZA” SIGN SYSTEM



several configurations

aluminium sliding panel

### CONNECTORS SIZES

\*mm

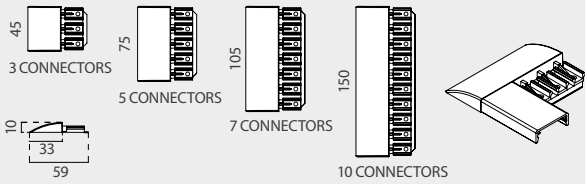

### CONNECTOR



15.310	3 Connectors	x10 
15.311	5 Connectors	x10 
15.312	7 Connectors	x10 
15.313	10 Connectors	x10 













### PROFILES DETAILS



### ALUMINIUM PROFILE



LENGTH

15.314	1 Connector	600mm	x4 
15.315	1 Connector	900mm	x4 
15.316	1 Connector	1400mm	x4 
15.317	2 Connectors	600mm	x4 
15.318	2 Connectors	900mm	x4 
15.319	2 Connectors	1400mm	x4 
15.320	3 Connectors	600mm	x4 
15.321	3 Connectors	900mm	x4 
15.322	3 Connectors	1400mm	x4 
15.323	3 Slide Connectors	600mm	x4 
15.324	3 Slide Connectors	900mm	x4 
15.325	3 Slide Connectors	1400mm	x4 

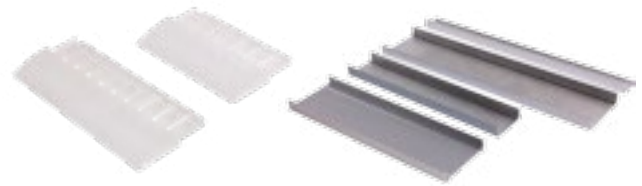





## SIGN SYSTEM CONTENT

- EN Signaling system with plastic frame that allows you to change the graphics easily. Available in different sizes.
- FR Système de signalisation en plastique qui permet le changement de visuel facilement. Disponible en plusieurs dimensions.
- PT Sistema de sinalização em plástico que permite a troca de imagem facilmente. Disponível em vários tamanhos.
- ES Sistema de señalización con marco de plástico que permite cambiar la gráfica fácilmente. Disponible en varios tamaños diferentes.

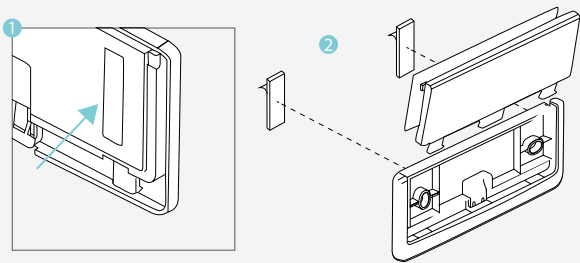

### INSTALLING EXPLANATION - FOAM ADHESIVE STRIP



DATA	SHAPE	SIZE
15.200		149x63mm
15.201		149x104mm
15.202		149x145mm

## DATA FRAME



### INSTALLING EXPLANATION - SCREWS

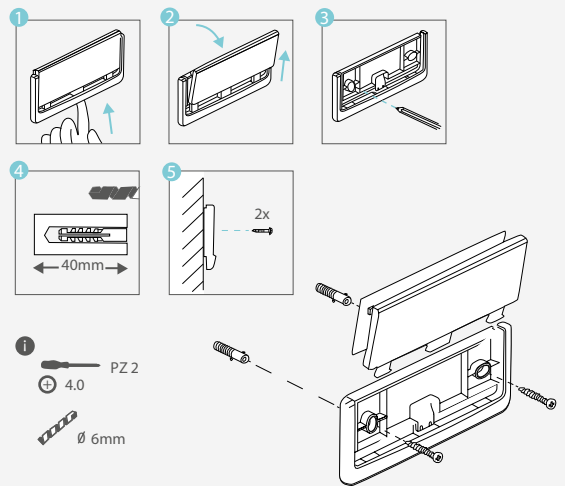

### EXTERNAL SIZE

\*mm



\* Custom printing in full color is available but not included.

ACRYLIC	SIZE
15.207	195x60mm
15.208	66x66mm

## DATA FRAME ACRYLIC



acrylic

adhesives included



## SIGN DETAILS

EN	2-sided flag sign system for fixing on the wall. Recommended materials: digital printing and vinyl cutting. Graphic and screws not included.
FR	Système composé de plaques d'aluminium 2 face à fixer au mur. Matières recommandées: vinyle decoupeet impression digitale. Graphique et vis non inclus.
PT	Sistema composto de placas de alumínio de 2 face para fixar à parede. Materiais recomendados: vinil de corte e impressão digital. Impressão e parafusos não incluídos.
ES	Sistema de señalización de banderola a 2 caras para fijar a pared. Materiales recomendados: impresión digital y vinilo de corte. Gráfica y tornillería no incluidas.



## PRINTING EXAMPLES



This is a selection of examples for printing. There are more signs available and also you can customize it with your design under request.

## SET-UP

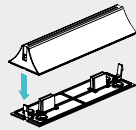

## SUPPORT

### COLOR SUPPORT



### SIZE

164x51x31mm

x5 

## SIGNAGE DOUBLE-SIDED VYNIL PRINTED

	SIZE	THICKNESS	
15.328	A5 (x2)	2mm	x5 
15.330	148x148mm (x2)	2mm	x5 

## HALLWAY SIGN



## EXTERNAL SIZES

\*mm

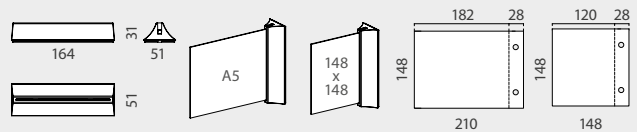

## SIGNAGE NO PRINTING

	SIZE	THICKNESS	
15.327	A5	2mm	x5 
15.329	148x148mm	2mm	x5 



## STRAIGHT FLAG



\*graphic and screws not included

## FLAG

## SIZE

15.685	220x90mm
15.686	320x90mm
15.687	220x124mm
15.688	320x124mm
15.689	420x124mm
15.690	150x150mm
15.691	220x150mm
15.692	320x150mm
15.693	420x150mm

## INSTALLING EXPLANATION

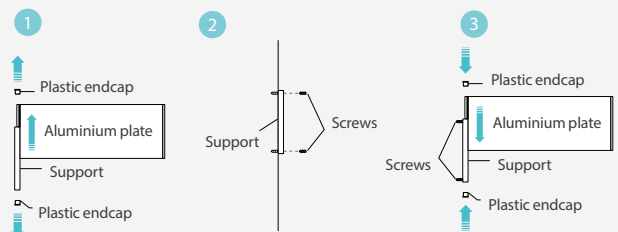

1. Remove the plastic endcaps and the aluminium plate.
2. Screw the aluminium support to the wall, as indicated.
3. Reattach the aluminium plate and the plastic endcaps.

This system contains:

- Double-sided aluminium plates
- Fixing support
- Plastic endcaps

## SIGN DETAILS

- EN Signage system with Led Light. It is supplied in complete kits. The transparent panel and mounting screws are not included.
- FR Système de signalisation avec lumière (LED). Vendus en jeux complets. Plaque transparente et vis non incluses.
- PT Sistema de sinalização com LEDs. Fornece-se em kits completos. Painel transparente e parafusos não incluídos.
- ES Sistema de señalización con luz LED. Se suministra en kits completos. Panel transparente y tornillería no incluidos.

## INFORMATION

\*mm

This system contains:

- Satin aluminium profile
- White LEDs inside
- Power supply
- Plug and wires

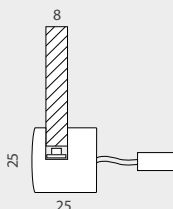

## LED LIGHT SIGN SYSTEM



\* glass or acrylic not included



LED SIGN	SIZE	LED	 
15.725	120mm	9 LEDs	
15.726	180mm	12 LEDs	
15.727	280mm	21 LEDs	

## INFORMATION

\*mm



## INFORMATION

\*mm

This pack contains:

- Stand-offs with 6 LED bulbs
- Power supply
- Plug and wires

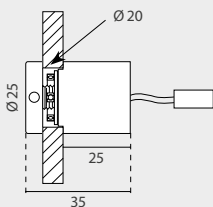



## LED LIGHT PANEL SUPPORT



\* glass or acrylic not included







LED PANEL	SIZE	 
15.724	Ø25x25mm	x4 

## SIGN DETAILS

EN	Double-sided flag sign system for fixing on the wall that allows to change the graphic information easily. Available in different sizes.
FR	Système de signalisation double face à fixer au mur qui permet le changement de visuel facilement. Disponible en plusieurs dimensions.
PT	Sistema de sinalização de dupla face para fixar à parede que permite a mudança de informação facilmente. Disponível em vários tamanhos.
ES	Sistemas de señalización de banderola a doble cara que permite cambiar la gráfica fácilmente. Disponible en varios tamaños.



FLAG	SHAPE	SIZE	  
15.203		297x120mm	
15.204		120x297mm	
15.205		210x297mm	
15.206		210x210mm	

## ACRYLIC FLAG

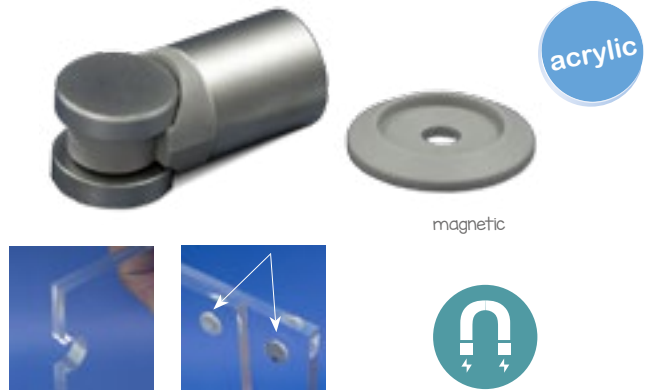

## INSTALLING EXPLANATION

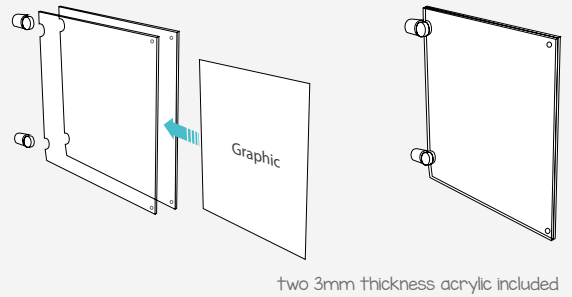

## EXTERNAL SIZES

\*mm

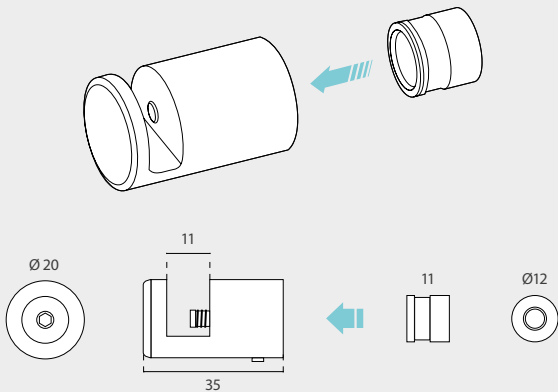

no need drilling holes on panel

MOUNTING	MAX. THICKNESS	SIZE	
15.249	11mm	Ø20x35mm	x4

## SIGNAGE MOUNTING



## INSTALLING EXPLANATION

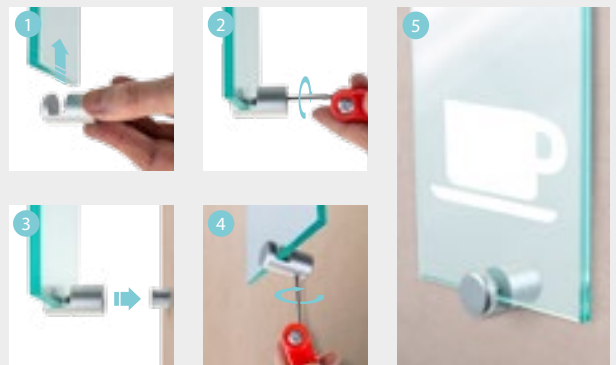



## SIGN DETAILS

EN	Wall mounting system for signage. This system allows to cover the fixing screws. Available in various finishes and colors.
FR	Système de fixation d'affiches au mur. Ce système permet de couvrir les vis de fixation. Diverses finitions et couleurs disponibles.
PT	Sistemas de fixação à parede de cartazes e ocultação de parafusos. Disponível em diferentes acabamentos e cores.
ES	Sistemas de fijación a pared de cartelería. Este sistema permite cubrir los tornillos de fijación. Disponible en varios acabados y colores.

easy wall mounting



## PLASTIC STANDOFFS FIXING



## EXTERNAL SIZE

\*mm

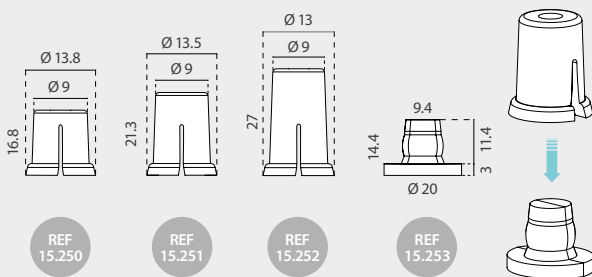

## INSTALLING EXPLANATION



## INFORMATION

The Plastic Stand-offs highlight the messages by adding a spacing effect. The Stand-Offs are made of Polystyrene and the mounting pieces are made of polycarbonate. 3 sizes available. Ideal to hold signs, 3D company letters or any other artworks.

1. Screw the Stand-Offs directly to the wall.
2. Attach the Mounting pieces to the Signage .
3. Fix the Signage with Mounting Pieces to the Stand-Offs.

### PLASTIC STANDOFF 16.8mm

SIZE

15.250



16.8mm

x20 

### PLASTIC STANDOFF 21.3mm

SIZE

15.251



21.3mm

x20 

### PLASTIC STANDOFF 27mm

SIZE

15.252



27mm

x20 

### PLASTIC STANDOFF 14.4mm

SIZE

15.253



14.4mm

x20 

Ideal as a directory signage



### SHARPED | SPIKE

	COLOR	SIZE	
15.567		Ø8x80mm	x2



### STRAIGHT CUT

	COLOR	SIZE	
15.568		Ø8x80mm	x2

## STEEL DESK SUPPORT



### SHARPED | SPIKE

	COLOR	SIZE	
15.569		Ø8x80mm	x2



### STRAIGHT CUT

	COLOR	SIZE	
15.570		Ø8x80mm	x2



create impactful displays

## SQUARE STANDOFF EDGE CLAMP

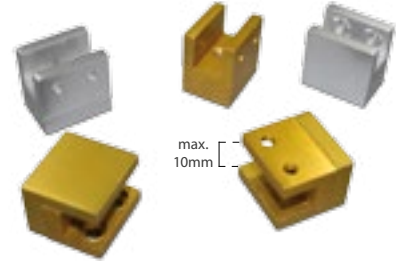

### GOLD COLOR

	COLOR	SIZE	
15.564		25x25mm	x4

### SILVER COLOR

	COLOR	SIZE	
15.565		25x25mm	x4



## ROUND STANDOFF EDGE CLAMP

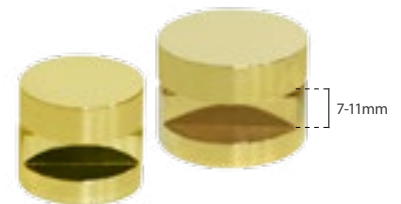

2 colors and diameters available

### CHROMED COLOR

	COLOR	SIZE	
15.550		Ø25x20mm	x4
15.551		Ø30x20mm	x4

### GOLD COLOR

	COLOR	SIZE	
15.552		Ø25x20mm	x4
15.553		Ø30x20mm	x4



## GOLD-CHROMED STANDOFF







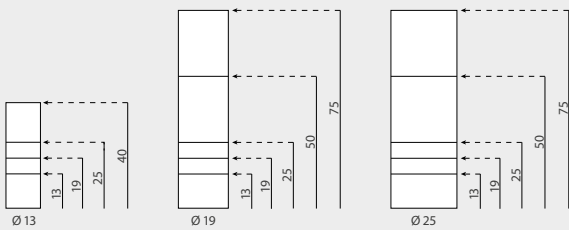





### EXTERNAL SIZES

\*mm



### GOLD-CHROMED STANDOFF Ø13mm







COLOR	SIZE		
	15.500	Ø13x13mm	x4 
	15.501	Ø13x19mm	x4 
	15.502	Ø13x25mm	x4 
	15.503	Ø13x40mm	x4 

COLOR	SIZE		
	15.504	Ø13x13mm	x4 
	15.505	Ø13x19mm	x4 
	15.506	Ø13x25mm	x4 
	15.507	Ø13x40mm	x4 















### GOLD-CHROMED STANDOFF Ø19mm

COLOR	SIZE		
	15.508	Ø19x13mm	x4 
	15.509	Ø19x19mm	x4 
	15.510	Ø19x25mm	x4 
	15.511	Ø19x50mm	x4 
	15.512	Ø19x75mm	x4 

COLOR	SIZE		
	15.513	Ø19x13mm	x4 
	15.514	Ø19x19mm	x4 
	15.515	Ø19x25mm	x4 
	15.516	Ø19x50mm	x4 
	15.517	Ø19x75mm	x4 

### GOLD-CHROMED STANDOFF Ø25mm

COLOR	SIZE		
	15.518	Ø25x13mm	x4 
	15.519	Ø25x19mm	x4 
	15.520	Ø25x25mm	x4 
	15.521	Ø25x50mm	x4 
	15.522	Ø25x75mm	x4 

COLOR	SIZE		
	15.523	Ø25x13mm	x4 
	15.524	Ø25x19mm	x4 
	15.525	Ø25x25mm	x4 
	15.526	Ø25x50mm	x4 
	15.527	Ø25x75mm	x4 







## SCREW COVERS









Ideal for creating name plates and guidance systems made of glass.

### CHROMED

	COLOR	SIZE			
15.544		Ø15mm	x4 		
15.545		Ø19mm	x4 		
15.546		Ø25mm	x4 		

### GOLDEN



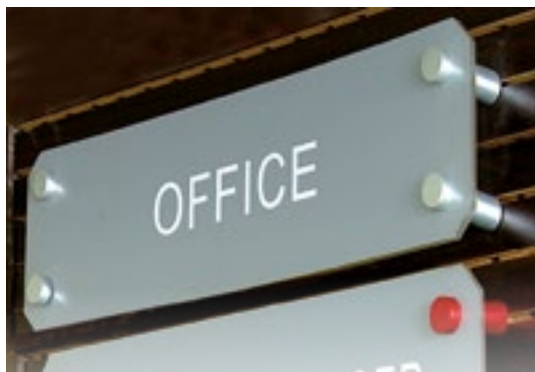



	COLOR	SIZE			
15.547		Ø15mm	x4 		
15.548		Ø19mm	x4 		
15.549		Ø25mm	x4 		



## ALUMINIUM STANDOFF



### Ø13x13mm

	COLOR	SIZE			
15.528		Ø13x13mm	x4 		
15.532		Ø13x13mm	x4 		
15.536		Ø13x13mm	x4 		
15.540		Ø13x13mm	x4 		

### Ø19x25mm

	COLOR	SIZE			
15.530		Ø19x25mm	x4 		
15.534		Ø19x25mm	x4 		
15.538		Ø19x25mm	x4 		
15.542		Ø19x25mm	x4 		

### Ø13x19mm

	COLOR	SIZE			
15.529		Ø13x19mm	x4 		
15.533		Ø13x19mm	x4 		
15.537		Ø13x19mm	x4 		
15.541		Ø13x19mm	x4 		

### Ø25x30mm

	COLOR	SIZE			
15.531		Ø25x30mm	x4 		
15.535		Ø25x30mm	x4 		
15.539		Ø25x30mm	x4 		
15.543		Ø25x30mm	x4 		

## SIGN DETAILS

EN	Panel Support system for shelves or for fixing posters to the wall. In gold or chrome finish. There are 2 sizes available.
FR	Système de fixation "Panel Support" d'étagères ou signalisation au mur. Disponible en chromé doré ou chromé argenté.
PT	Sistema fixação à parede de prateleiras ou impressões. Disponível em dourado ou prateado com acabamento cromado.
ES	Sistema de fijación de estantes o cartelería a pared. Disponibles en acabado dorado o cromado y en dos tamaños de fijación.



REF 15.558



REF 15.559



REF 15.560



REF 15.561

## EDGE CLAMP

	COLOR	SIZE	MAX. THICKNESS	
15.558		35x35mm	12mm	x4 
15.560		25x25mm	9.5mm	x4 

	COLOR	SIZE	MAX. THICKNESS	
15.559		35x35mm	12mm	x4 
15.561		25x25mm	9.5mm	x4 



REF 15.554



REF 15.557

## EDGE CLAMP

	COLOR	SIZE	MAX. THICKNESS	
15.554		30mm	7.5mm	x2 
15.555		50mm	9.5mm	x2 

	COLOR	SIZE	MAX. THICKNESS	
15.556		30mm	7.5mm	x2 
15.557		50mm	9.5mm	x2 



REF 15.563



REF 15.562

## EDGE CLAMP

	COLOR	SIZE	MAX. THICKNESS	
15.562		80x28mm	12mm	x4 
15.563		50x25mm	10mm	x4 

## PANEL SUPPORT EDGE CLAMP



## OUTDOOR SIGN SYSTEM

### SIGN DETAILS

**EN** Outdoor signage system in two standard measures, composed by two aluminium poles for ground mounting and double sided aluminium profiles for a better viewing.

**FR** Système de signalisation extérieure en 2 dimensions standard. Composé de 2 poteaux en aluminium à fixer au sol et des profils en aluminium double face pour une meilleure visualisation.

**PT** Sistema de sinalização exterior em duas medidas standar, composto por dois postes de alumínio para fixação ao solo e perfis de alumínio com dupla face para uma melhor visualização.

**ES** Sistema de señalización exterior en dos medidas estándar, compuesto de dos postes de aluminio para fijación al suelo y perfiles de aluminio a doble cara para una mejor visualización.



### EXTERNAL SIZES

\*mm

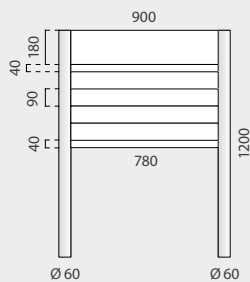

### INFORMATION

This sign includes:

- 2 aluminium poles (Ø60x1200mm)
  - 2 plastic endcaps per post
  - 1 aluminium profile 180mm height
  - 2 aluminium profiles 40mm height
  - 4 aluminium profiles 90mm height
- It is ideal for creating outdoor guidance systems.

### OUTDOOR SIGN

SIZE

15.716 900x1200mm

### EXTERNAL SIZES

\*mm

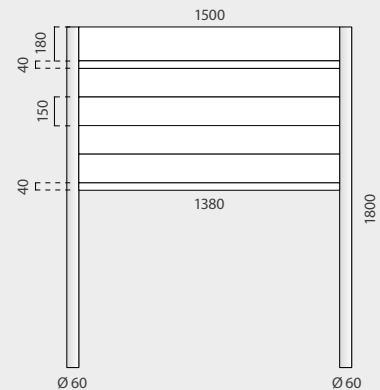

### INFORMATION

This sign includes:

- 2 aluminium poles (Ø60x1800mm)
  - 2 plastic endcaps per post
  - 1 aluminium profile 180mm height
  - 2 aluminium profiles 40mm height
  - 4 aluminium profiles 150mm height
- It is ideal for creating outdoor guidance systems.

### OUTDOOR SIGN

SIZE

15.717 1500x1800mm

# CABLEKIT 09

Complete range of signage systems through steel cables and tensors which provide an integral solution for the exhibition at selling point areas.

- 402** OMEGA SYSTEM
- 404** DELTA SYSTEM
- 406** GAMMA SYSTEM
- 408** EPSILON SYSTEM
- 410** FREE STANDING
- 411** ACRYLIC POCKET
- 412** LIGHT BOX

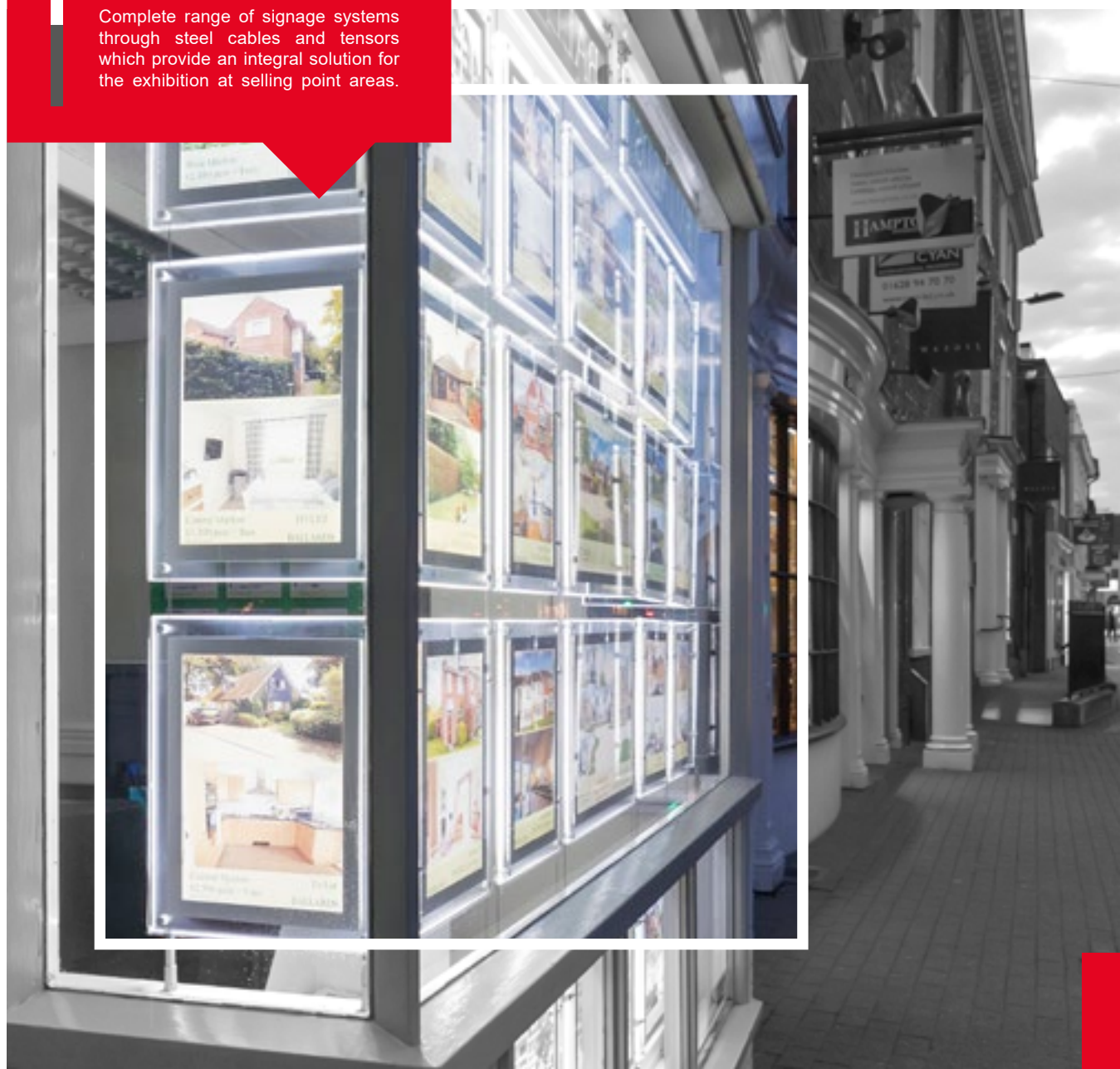



## OMEGA FIXING KIT

DETAIL	KIT INCLUDES	INFORMATION
		Fixing kit contains: 3m length wire cable + 1 top fixing unit + 1 bottom fixing unit. The Omega Kit is ideal for storefronts, travel agencies or for banks.
FIXING KIT		
12.547	x2 	

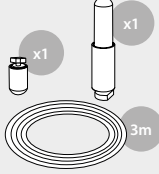

## OMEGA CHANNEL KIT

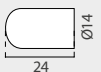
DETAIL	KIT INCLUDES	INFORMATION
		Channel kit contains: 3m length wire cable + 1 top channel unit + 1 bottom channel unit. Omega Kit is ideal for storefronts, travel agencies or for banks.
CHANNEL KIT		
12.546	x2 	

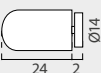

## OMEGA TOP FIXING

DETAIL	SIZE *mm	INFORMATION
		This metallic unit is suitable for a top fixation with the ceiling. It features a satin silver finish.
TOP FIXING	SIZE	
12.544	Ø14x24mm	x10 

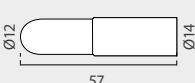

## OMEGA TOP CHANNEL

DETAIL	SIZE *mm	INFORMATION
		This metallic unit is suitable for a top fixation with channel connector. It features a satin silver finish.
TOP CHANNEL	SIZE	
12.542	Ø14x26mm	x10 

## OMEGA BOTTOM FIXING

DETAIL	SIZE *mm	INFORMATION
		Metallic unit for a bottom fixation with the floor. With a satin silver finish.
BOT. FIXING	SIZE	
12.545	Ø14x57mm	x10 

## OMEGA BOTTOM CHANNEL

DETAIL	SIZE *mm	INFORMATION
		Metallic unit for being used with channel connector. With a satin silver finish.
BOT. CHANNEL	SIZE	
12.543	Ø14x59mm	x10 



## OMEGA SYSTEM





\* Acrylic Pockets at this page are available but not included

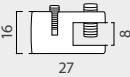

## OMEGA SINGLE POCKET CLIP

DETAIL	SIZE	*mm	INFORMATION
			This metallic single pocket clip is suitable for wires up to Ø1.5mm - Ø3mm. With silver finish.
SINGLE CLIP	SIZE		
12.540	Ø16x27mm	x10 	

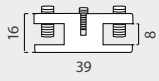



## OMEGA DOUBLE POCKET CLIP

DETAIL	SIZE	*mm	INFORMATION
			Double metallic single panel clip for wires up to Ø1.5mm - Ø3mm. With silver finish.
DOUBLE CLIP	SIZE		
12.541	Ø16x39mm	x10 	

## ALUMINIUM TRACK

DETAIL	INFORMATION
	This track aluminium features 2 lengths available (2m or 3m).
TRACK	LENGTH
12.127	2000mm
12.128	3000mm



## TRACK ENDCAP

DETAIL	SIZE	*mm	INFORMATION
			Connect this endcap to the aluminium track. Made of gray plastic.
ENCAP	SIZE		
12.428	31x25mm	x10 	

## WIRE CABLE

DETAILS	INFORMATION	
		
	Roll of wire cable suitable for Cablekit systems, with a length of 25m. 2 diameters available: Ø1.5mm and Ø3mm.	
WIRE CABLE	LENGTH	Ø WIRE
12.315	25m	1.5mm
12.311	25m	3mm

## OMEGA LOAD

DETAIL	SIZE	*mm	INFORMATION
			This Ø40 Aluminium load for wires is 500g weight. 170mm height.
LOAD	SIZE	WEIGHT	
12.117	Ø40x170mm	500g	

## OMEGA SYSTEM

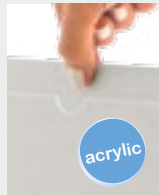
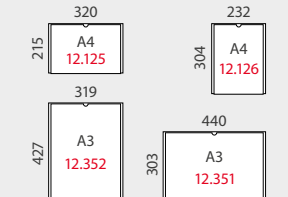

## ACRYLIC POCKET

DETAILS	INFORMATION	*mm
		
		

This transparent 2mm acrylic Pocket folder features 2 formats with 2 orientations.

POCKET	STANDARD FORMATS			
12.125	A4 Horizontal	x10 		
12.351	A3 Horizontal	x10 		
12.126	A4 Vertical	x10 		
12.352	A3 Vertical	x10 		

## DELTA TOP/WALL FIXING

FIXING DETAIL

INFORMATION

\*mm

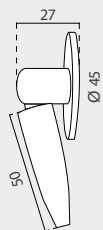

This movable and stylish Top Support is suitable for ceiling or wall. It includes adjust for tension. Convenient for wire with a diameter of Ø1.5mm or Ø3mm. With chrome finish. Ideal for storefronts, travel agencies or banks.

WALL FIXING

BASE SIZE

12.316

Ø45x27mm

x4 

## DELTA TOP/BOTTOM FIXING

FIXING DETAIL

INFORMATION

\*mm

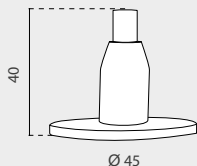

Elegant and fixed support for ceiling or floor. Convenient for wire with a diameter of Ø1.5mm or Ø3mm. With chrome finish. Ideal for real states, storefronts, travel agencies or banks.

BOTTOM FIXING

SIZE

12.317

Ø45x40mm

x4 

## CHROMED POCKET CLIP

CLIP DETAIL

SIZE

\*mm

INFORMATION

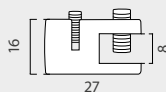

This chromed pocket fixing Clip is suitable for a single pocket. It is convenient for wire with a diameter of Ø1.5mm or Ø3mm.

CHROMED CLIP

SIZE

12.318

Ø16x27mm

x10 

## DOUBLE CHROMED POCKET CLIP

CLIP DETAIL

SIZE

\*mm

INFORMATION

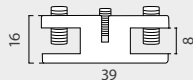

This chromed pocket fixing Clip is suitable for 2 pockets. It is convenient for wire with a diameter of Ø1.5mm or Ø3mm.

DOUBLE CH.

SIZE

12.319

Ø16x39mm

x10 

## DELTA SYSTEM

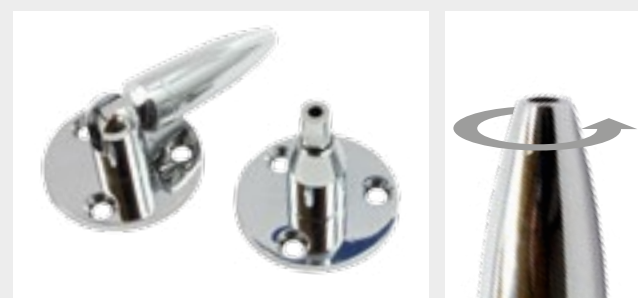

\* Acrylic Pockets at this page are available but not included

## WIRE CABLE Ø 1mm

CABLE DETAIL		INFORMATION	
	Ø 1mm	Roll of wire cable suitable for Cablekit systems. With a diameter of Ø1mm and a length of 25m. This hanging wire cable provides tension and firmness to the displaying of pockets.	
Ø1 CABLE	LENGTH	Ø WIRE	
12.121	25m	1mm	

## WIRE CABLE Ø 1.5mm



CABLE DETAIL		INFORMATION	
	Ø 1.5mm	Roll of wire cable suitable for Cablekit systems. With a diameter of Ø1.5mm and a length of 25m. This hanging wire cable provides tension and firmness to the displaying of pockets.	
Ø1.5 CABLE	LENGTH	Ø WIRE	
12.315	25m	1.5mm	

## WIRE CABLE Ø 3mm





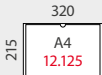
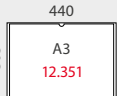



CABLE DETAIL		INFORMATION	
	Ø 3mm	Roll of wire cable suitable for Cablekit systems. With a diameter of Ø3mm and a length of 25m. This hanging wire cable provides tension and firmness to the displaying of pockets.	
Ø3 CABLE	LENGTH	Ø WIRE	
12.311	25m	3mm	

## ACRYLIC POCKET

DETAILS	
	

INFORMATION		*mm
		
		

This transparent 2mm acrylic Pocket folder features 2 formats with 2 orientations.

POCKET	STANDARD FORMATS			
12.125	A4 Horizontal	x10		
12.351	A3 Horizontal	x10		
12.126	A4 Vertical	x10		
12.352	A3 Vertical	x10		

## DELTA SYSTEM



## GAMMA TOP/WALL FIXING

FIXING DETAIL SIZE \*mm

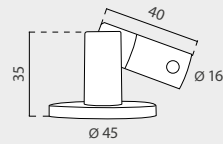

### INFORMATION

This movable and stylish Top Support is suitable for ceiling or wall. Convenient for wire with a diameter of Ø1.5mm or Ø3mm. With chrome finish. It is ideal for storefronts, travel agencies or banks.

WALL FIXING	BASE SIZE	
12.312	Ø45x35mm	x4 

## GAMMA WALL/BOTTOM FIXING

FIXING DETAIL SIZE \*mm

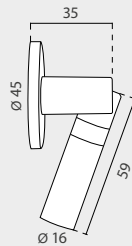

### INFORMATION

This movable and stylish bottom support is suitable for wall or floor placement. It includes adjust for tension Convenient for cable wire up to Ø1.5 - Ø3mm. With silver finish. Ideal for real states, for storefronts, travel agencies or banks, creating advertisement mosaics.

BOTTOM FIXING	BASE SIZE	
12.313	Ø45x35mm	x4 

## GAMMA SINGLE POCKET CLIP

CLIP DETAIL



INFORMATION SIZE \*mm

This silver Vertical fixing Clip is suitable for holding a single panel. Convenient for cable wire with a diameter of Ø1.5mm or Ø3mm.

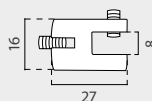

CHROMED CLIP	SIZE	
12.314	Ø16x27mm	x10 

## GAMMA SYSTEM



\* Acrylic Pockets at this page are available but not included

# GAMMA SYSTEM

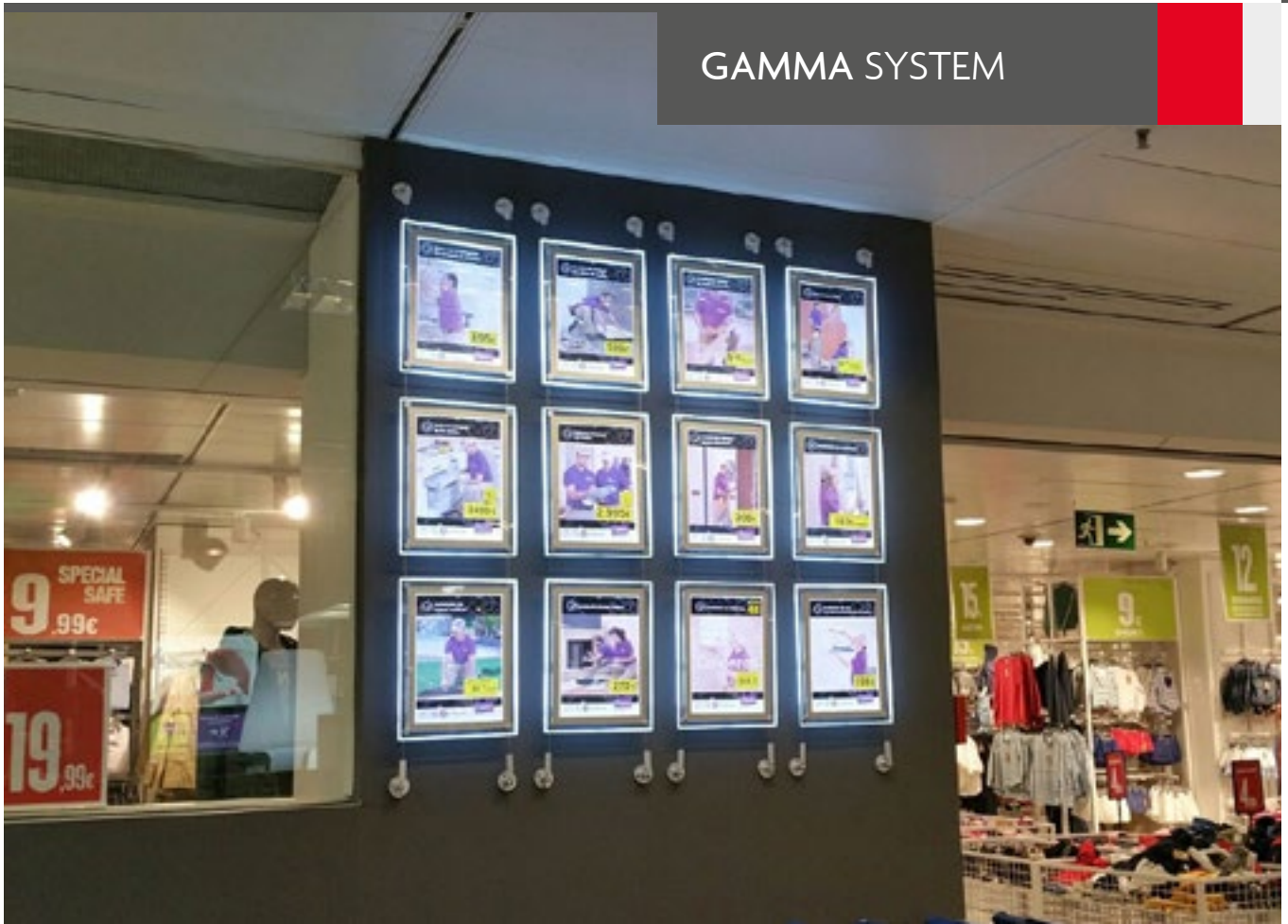

## WIRE CABLE Ø 1.5mm

### CABLE DETAIL

### INFORMATION

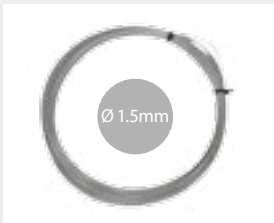

Roll of wire cable suitable for Cablekit systems. With a diameter of Ø1.5mm and a length of 25m. This hanging wire cable provides tension and firmness to the displaying of pockets.

Ø1.5 CABLE	LENGTH	Ø WIRE
12.315	25m	1.5mm

## WIRE CABLE Ø 3mm

### CABLE DETAIL

### INFORMATION



Roll of wire cable suitable for Cablekit systems. With a diameter of Ø3mm and a length of 25m. This hanging wire cable provides tension and firmness to the displaying of pockets.

Ø3 CABLE	LENGTH	Ø WIRE
12.311	25m	3mm

## ACRYLIC POCKET

### POCKET DETAILS







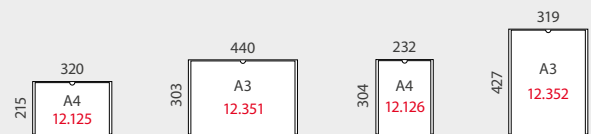



### INFORMATION

\*mm



This transparent 2mm acrylic Pocket folder features 2 formats with 2 orientations.

POCKET	STANDARD FORMATS			
12.125	A4 Horizontal	x10		
12.351	A3 Horizontal	x10		
12.126	A4 Vertical	x10		
12.352	A3 Vertical	x10		

\* Magnetic Light Boxes at this page are available but not included

## EPSILON TOP/WALL FIXING

FIXING DETAIL INFORMATION \*mm

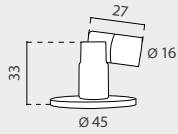

This movable and stylish Support is suitable for ceiling or wall. Convenient for cable wire up to Ø1.5 - Ø3mm. With chrome finish. Ideal for real states, for storefronts, travel agencies or banks.

BOTTOM FIXING	SIZE	
12.320	Ø45x40mm	x4 

## EPSILON SYSTEM

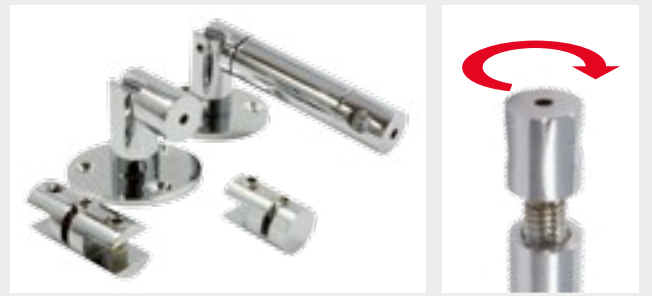

## EPSILON WALL/BOTTOM FIXING

FIXING DETAIL INFORMATION \*mm

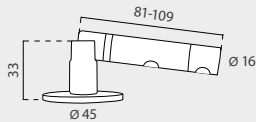

This movable and stylish Support is suitable for bottom/floor or wall. It includes adjust for tension. Convenient for cable wire up to Ø1.5 - Ø3mm. With chrome finish. Ideal for real states, travel agencies or banks.

WALL FIXING	BASE SIZE	
12.321	Ø45x33mm	x4 

## CHROMED POCKET CLIP

CLIP DETAIL \*mm INFORMATION

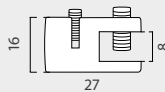

This chromed pocket fixing Clip is suitable for a single pocket. It is convenient for wire with a diameter of Ø1.5mm or Ø3mm.

CHROMED CLIP	SIZE	
12.318	Ø16x27mm	x10 

## DOUBLE CHROMED POCKET CLIP

CLIP DETAIL \*mm INFORMATION

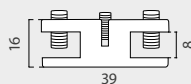

This chromed pocket fixing Clip is suitable for 2 pockets. It is convenient for wire with a diameter of Ø1.5mm or Ø3mm.

DOUBLE CH.	SIZE	
12.319	Ø16x39mm	x10 



\* Acrylic Pockets at this page are available but not included

## WIRE CABLE Ø 1mm

### CABLE DETAIL



Roll of wire cable suitable for Cablekit systems. With a diameter of Ø1mm and a length of 25m. This hanging wire cable provides tension and firmness to the displaying of pockets.

Ø1 CABLE	LENGTH	Ø WIRE
12.121	25m	1mm

## WIRE CABLE Ø 1.5mm

### CABLE DETAIL



Roll of wire cable suitable for Cablekit systems. With a diameter of Ø1.5mm and a length of 25m. This hanging wire cable provides tension and firmness to the displaying of pockets.

Ø1.5 CABLE	LENGTH	Ø WIRE
12.315	25m	1.5mm

## WIRE CABLE Ø 3mm

### CABLE DETAIL

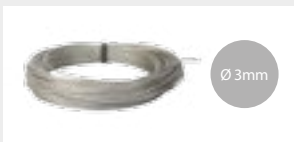

Roll of wire cable suitable for Cablekit systems. With a diameter of Ø3mm and a length of 25m. This hanging wire cable provides tension and firmness to the displaying of pockets.

Ø3 CABLE	LENGTH	Ø WIRE
12.311	25m	3mm

## ACRYLIC POCKET

### POCKET DETAILS





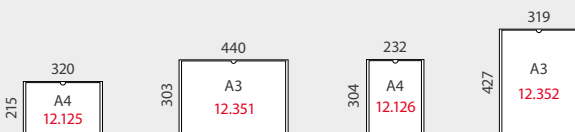

### INFORMATION

\*mm



This transparent 2mm acrylic Pocket folder features 2 formats with 2 orientations.

POCKET	STANDARD FORMATS			
12.125	A4 Horizontal	x10		
12.351	A3 Horizontal	x10		
12.126	A4 Vertical	x10		
12.352	A3 Vertical	x10		

## EPSILON SYSTEM



# FREE STANDING Free Standing

## STAND DETAILS



12.354 FREE STANDING      KIT CONTENT      \*mm

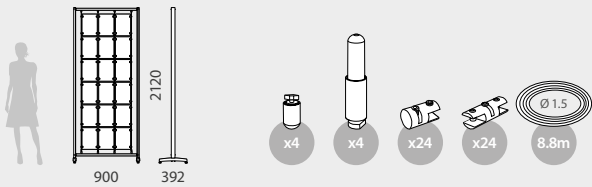

12.355 FREE STANDING      KIT CONTENT      \*mm

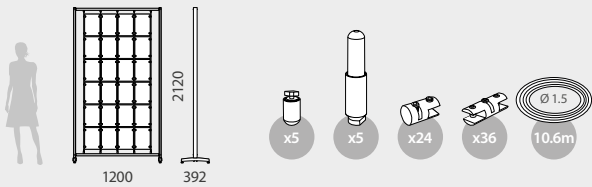

12.356 FREE STANDING      KIT CONTENT      \*mm

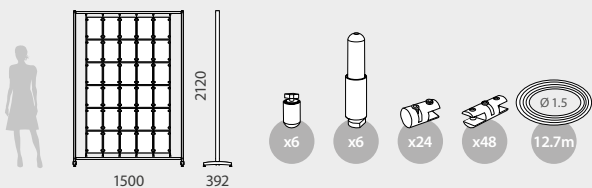

## INFORMATION

The Free Standing is a cable support system for aluminum frame with feet and levelers. Featuring 3 different models. Every kit of Free Standing includes: 1 aluminium Framework, Top connectors, Bottom connectors, Single pocket clips, Double pocket clips and Ø1.5mm cable. Acrylic pockets not included.

FREE STANDING	OUTER SIZE
12.354	900x2120x392mm
12.355	1200x2120x392mm
12.356	1500x2120x392mm

## FREE STANDING

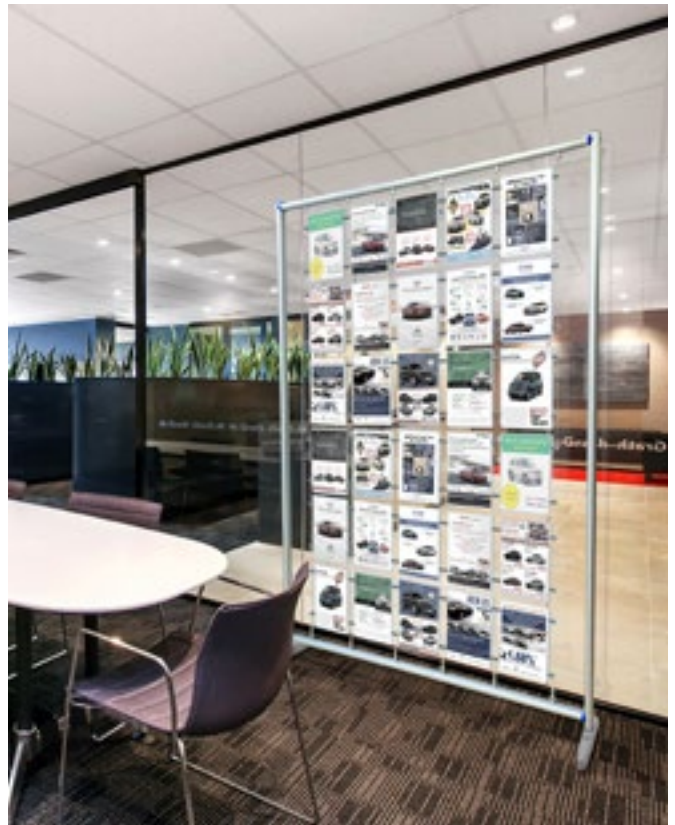

\* Acrylic Pockets at this page are available but not included



## POCKET DETAILS

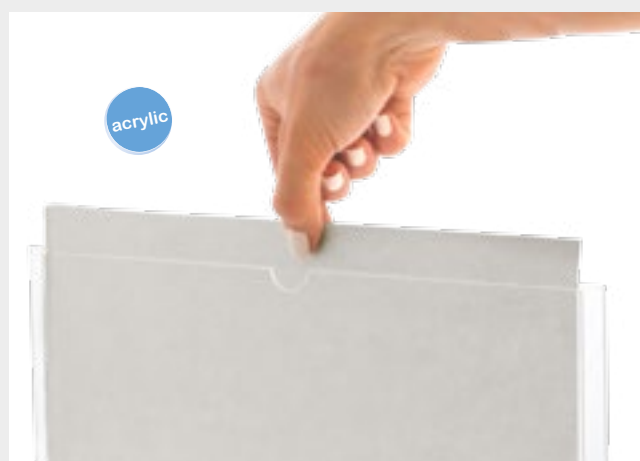



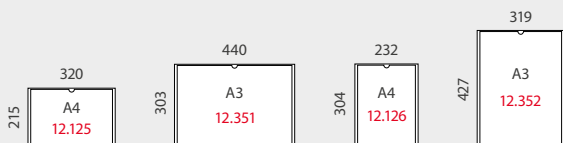

## FORMATS \*mm



## INFORMATION

These transparent Pocket folders are made of 2mm acrylic thickness and 2 sizes are available (A3 and A4). It features an easy and simple graphic change. Also, portrait and landscape orientation of both sizes are available. These holder pockets can be used in a wide range of ways so users can create their own display based on their needs.

POCKET	STANDARD FORMATS				
12.125	A4 Horizontal	x10			
12.351	A3 Horizontal	x10			
12.126	A4 Vertical	x10			
12.352	A3 Vertical	x10			

## ACRYLIC POCKET



\* Cable kits at this page are available but not included

LIGHTBOX DETAILS



DIMENSIONS ARTWORK \*mm

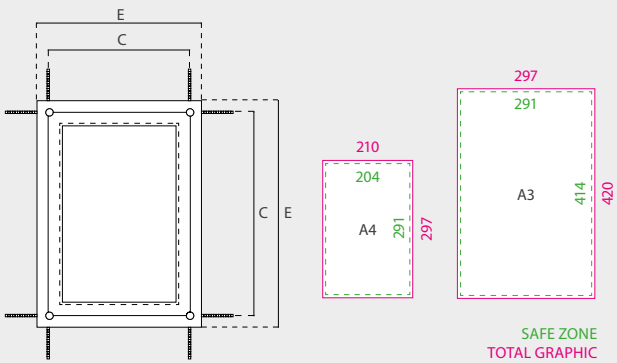

LIGHTBOX SIZE	E (EXTERNAL)	C (CABLE DISTANCE)	BRIGHTNESS	VOLTAGE	POWER
A4	276x363mm	240x327mm	≥ 1500LUX	12V	4.8W
A3	363x486mm	327x450mm	≥ 1500LUX	12V	9.6W

INFORMATION

Light Boxes use 12V safe power and ultra bright LED lights and they are suitable for being used with any of the CableKit systems. Light Boxes feature a magnetic sealed design which makes it easy and fast to change the graphics. Compatible up to Ø1.5mm cable, these holder boxers can be used in a wide range of ways so users can create their own light display based on their needs. It features 2 formats (A4 and A3) with double sided format. The Kit Power Supply and its Power Connector are supplied separately. Ideal for being used on showcases, art exhibitions, storefronts, restaurants, hotels, banks, travel agencies, etc...

DOUBLE A4	QTY	N.W	G.W	C.B.M	SIZE
Packing	2	2.1kg	2.5kg	0.121	410x330x90mm
		Graphic size		External size	
12.550	2 Sided A4	363x276x8mm		x2	

DOUBLE A3	QTY	N.W	G.W	C.B.M	SIZE
Packing	2	3.5kg	4kg	0.02	550x410x90mm
		Graphic size		External size	
12.551	2 Sided A3	486x363x8mm		x2	

LIGHT BOX



## KIT POWER SUPPLY FOR LIGHT BOX

### POWER SUPPLY DETAILS

### KIT INCLUDES



### INFORMATION

Supply Kit has 12V safe power and contains 1 Power Cord and 1 Connector cable.

POWER SUPPLY	POWER	CABLE LENGTH
12.552	12V 2A	2.5+1.5m

## POWER CONNECTOR FOR LIGHT BOX

### CONNECTORS DETAILS

### SIZE

\*mm

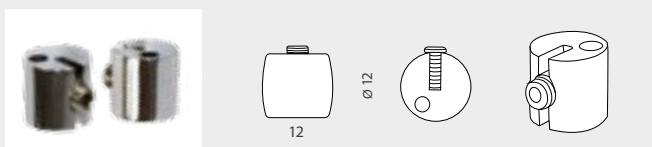

### INFORMATION

These Power Connectors join the LED Lightboxes with the tension wire cable.

CONNECTOR	SIZE
12.553	Ø12x12mm x4 

## FOR ANY CABLEKIT SYSTEM AVAILABLE

### CABLE KIT DETAILS

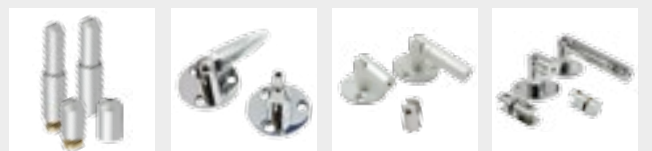

### INFORMATION

Light Boxes are suitable for being used with any of our CableKit systems.

## WIRE CABLE

### CABLE DETAILS

### INFORMATION



Roll of wire cable suitable for Cablekit systems, with a length of 25m. 2 diameters available: Ø1mm and Ø1.5mm.

WIRE CABLE	LENGTH	Ø WIRE
12.121	25m	1mm
12.315	25m	1.5mm

## LIGHT BOX





# PRODUCT EXHIBITION 10

Complete range of dispensers, tower units for the product exhibition which provide an integral solution for the selling exhibition.

- 416** SHELVING DISPLAYS
- 419** DUMPBIN DISPLAYS
- 420** DISPENSER DISPLAYS
- 425** BOWL DISPENSERS
- 427** CARDBOARD DISPLAYS
- 430** TURNTABLES
- 433** CUBE SYSTEM
- 434** ACRYLIC DISPLAYS
- 446** HANDBAG DISPLAYS



# SHELVING DISPLAY Multifunction Shelf

## SHELVES + COVERS + CAPS

## CUSTOMIZATION PACK 1



TINEO PACK 1	QTY	N.W	G.W	C.B.M	SIZE
Packing	1	4.1kg	4.6kg	0.0437	420x400x260mm
Color	<input checked="" type="checkbox"/>	<input checked="" type="checkbox"/>	<input checked="" type="checkbox"/>	<input type="checkbox"/>	
13.719	4 Shelves + 4 Top Covers + 4 End Caps				

## DIMENSIONS

\*mm



## INFORMATION

With exposed sides, this 4-sided plastic shelving unit lets customers easily access the items on display while also providing you a means to quickly restock. Customize your Tineo and choose 1 color for a first pack of 4 shelves (A) 4 top covers (B) and 4 end caps (C). Then choose a second color for the pack of 12 Poles (D) and 4 Bottom Feet (E). Tineo has multiple functions for selling, displaying or promoting products, so it is a practical shelving unit that will look great in markets, retail stores, exhibition events or even at home.

## POLES + FEET

## CUSTOMIZATION PACK 2

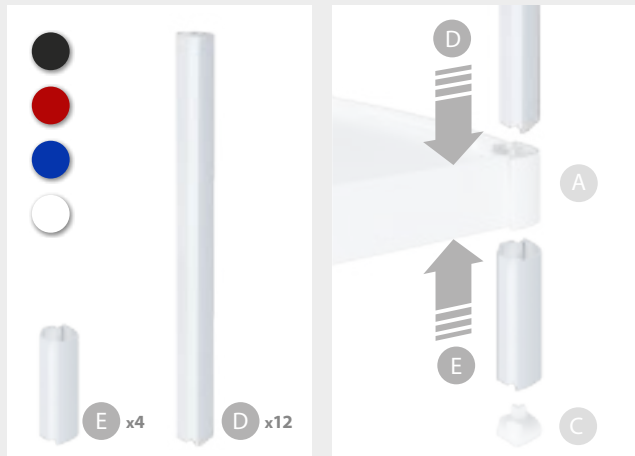

TINEO PACK 2	QTY	N.W	G.W	C.B.M	SIZE
Packing	1	1.70kg	2.05kg	0.0110	415x355x75mm
Color	<input checked="" type="checkbox"/>	<input checked="" type="checkbox"/>	<input checked="" type="checkbox"/>	<input type="checkbox"/>	
13.720	4 Poles + 4 Bottom Feet				

## TINEO MULTIFUNCTION SHELF STAND

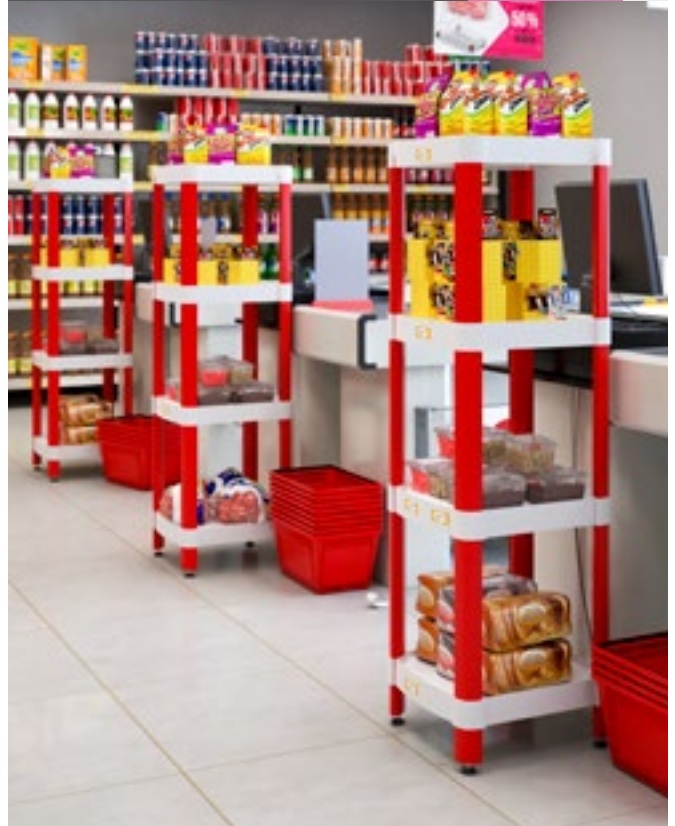

# SHELVING DISPLAY Multifunction Shelf

## CUSTOMIZATION POSSIBILITIES (APPLIED BY THE CUSTOMER)



## INFORMATION

To make things even easier, the Multi-function Tineo Shelf Stand is designed to support new configurations applied by the customer, such as turning it into a display cabinet unit by using panels or incorporating graphics to the sides. Easy to assemble, each piece is designed for quick installation and use. Also, if you want to turn this shelf display to mobile, wheels for Tineo Shelf Stand are also available.

## TINEO MULTIFUNCTION SHELF STAND



## WHEELS FOR TINEO

### WHEELS DETAILS





WHEELS	QTY	N.W	G.W	C.B.M	SIZE
Packing	4	0.3kg	0.35kg	0.0008	130x105x60mm
14.102	2 Wheels + 2 Brake Wheels		x4		

## FEET FOR TINEO

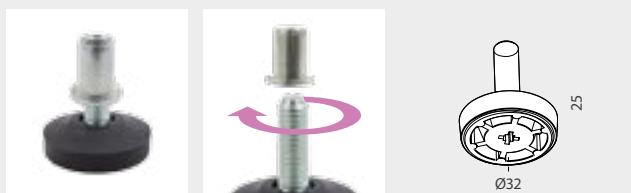

### FEET DETAILS



FEET	QTY	N.W	G.W	C.B.M	SIZE
Packing	4	0.084kg	0.13kg	0.0005	70x105x70mm
14.202	4 Adjustable feet		x4		

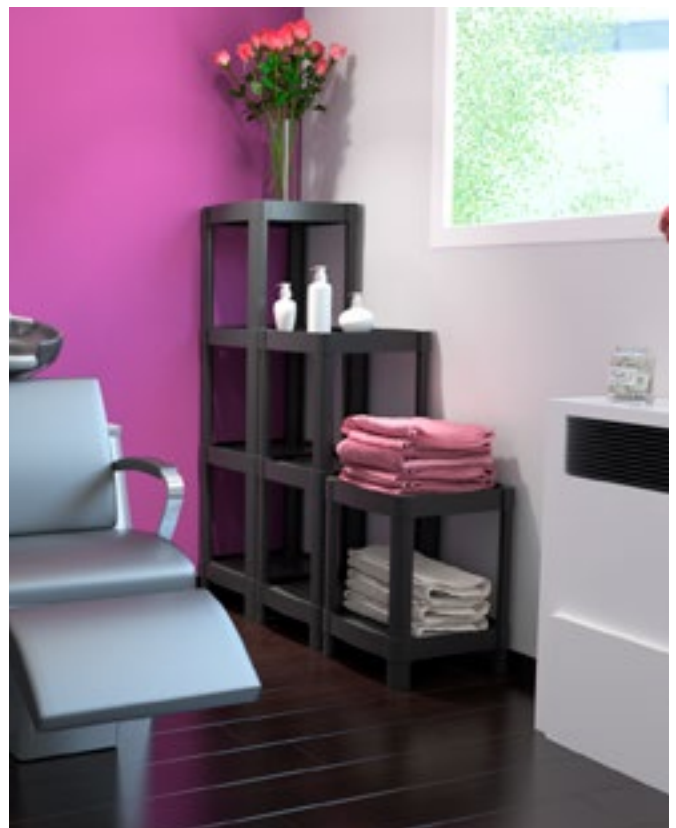

\* Customization options are not included. / \* Les possible personnalisation ne sont pas incluses. / \* As possibilidades de personalização em nenhum caso são fornecidas. / \* Las opciones de personalización no están incluidas.

# SHELVING DISPLAY Multifunction Shelf

## DISPLAY DETAILS



## DIMENSIONS

\*mm

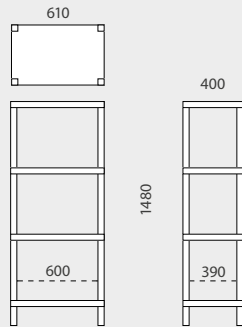

## INFORMATION

The Shelf display is fully removable, also it is lightweight and it features 4 different colors available. With exposed sides, this 4-sided plastic shelving unit lets customers easily access the items on the display while also providing you a means to quickly restock. Easy to set up in only a few seconds, this shelving display will look great in supermarkets or retail stores, supermarkets, exhibition events or even at home.

SHELF D.	QTY	N.W	G.W	C.B.M	SIZE
Packing	1	8kg	8.45kg	0.073	400x290x630mm

10.384



10.386



10.387



10.388



620x400x1480mm

## SHELF DISPLAY





# DUMPBIN DISPLAY Shelf Display | Wire Dumpbin

## DISPLAY DETAILS



## INFORMATION

\*mm

This "Easy" Display is made of injected plastic with cardboard. It has 3 shelves and top surface of a lower module with wheels. So in this way you have 4 spaces for displaying and exhibition of the product. Also, you can add your customised print to the top header and faces of the cardboard lower module (included) to suit your own requirements. This mobile display is very easy to move inside your business. Place the piece near the point of purchase locations for impulse buys on any merchandise you choose.

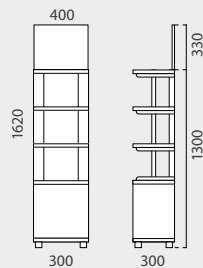

"EASY"	QTY	N.W	G.W	C.B.M	SIZE
Packing	1	4kg	4.8kg	0.0572	520x155x710mm
10.478	Top Graphic Size: 400x330mm				

## "EASY" DISPLAY



## DISPLAY DETAILS

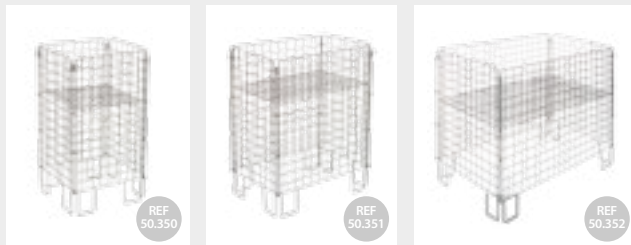

## INFORMATION

\*mm

Wire steel dumpbin features a collapsible design which allows an easy setup, packing and storing. Frame spacing allows for lifts to be used during store resets. It is ideal for displaying last minute add-on items on the point of sale.

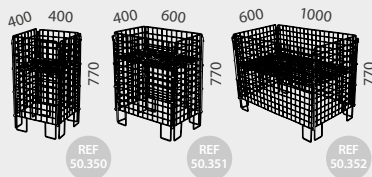

WIRE D1	QTY	N.W	G.W	C.B.M	SIZE
Packing	1	7.2kg	8.4kg	0.2	795x425x550mm
50.350	400x400x770mm				

WIRE D2	QTY	N.W	G.W	C.B.M	SIZE
Packing	1	8.8kg	10.2kg	0.27	795x620x550mm
50.351	600x400x770mm				

WIRE D3	QTY	N.W	G.W	C.B.M	SIZE
Packing	1	13.6kg	15.2kg	0.52	1205x790x550mm
50.352	1000x600x770mm				

## WIRE DUMPBIN



## DISPLAY DETAILS



## INFORMATION

\*mm

This squared transparent dumpbin features 1 shelf and the possibility of placing it in 2 different heights (370mm or 610mm) and get 2 different capacities of exhibition. Also, you can add your customized print to one or more faces of the bin to suit your own requirements. The edge of the upper perimeter is reinforced with protective cover. Promo Square is ideal for displaying of toys, candies, cosmetics, merchandising, samples, gifts or last minute add-on items.

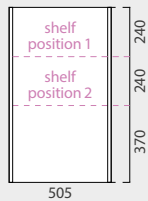

P.SQUARE	QTY	N.W	G.W	C.B.M	SIZE
Packing	1	4.35kg	5.1kg	0.02	540x45x900mm
10.440	Graphic Size: 610x505mm(x4) or 370x505(x4)				

## PROMO SQUARE DUMPBIN



## DISPLAY DETAILS



## INFORMATION

\*mm

This stand dispenser features 1 front mouth and is easy to set-up. It allows to customize it with your own graphics. Perfect as eye-catching point of purchase presentation on any counter to display the last minute add-on items, for customers to purchase as they are checking out

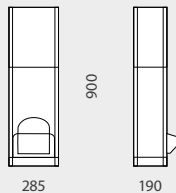

TABLE DISPLAY	QTY	N.W	G.W	C.B.M	SIZE
Packing	1	2.5kg	3.6kg	0.058	300x210x920mm
10.475	Total Display Size: 285x190x900mm				

## TABLE DISPLAY



## DISPLAY DETAILS



## INFORMATION

This merchant stand features 1 front mouth and is easy to set-up. It allows to customize it with your own graphics. Perfect as eye-catching point of purchase presentation on any counter to display the last minute add-on items, for customers to purchase as they are checking out

## DIMENSIONS

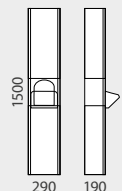

## TEMPLATE

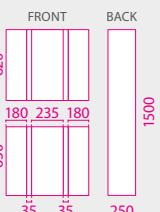

WALL DISPLAY	QTY	N.W	G.W	C.B.M	SIZE
Packing	1	3.7kg	5.46kg	0.1238	335x240x1540mm
10.476	Total Display Size: 290x190x1500mm				

## WALL DISPLAY



## DISPLAY DETAILS



## DIMENSIONS

This floor display features 2 front mouth pieces and is easy to set-up. Ideal as eye-catching point of purchase presentation on any counter to display the last minute add-on items at retail stores, supermarkets, bakeries, toy stores or tradeshows. Personalization with printing on adhesive is available but not included.

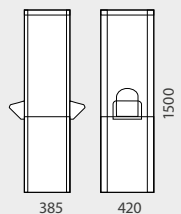

FLOOR DISPLAY	QTY	N.W	G.W	C.B.M	SIZE
Packing	1	7.35kg	8.2kg	0.27	450x400x1520mm
10.477	Total Display Size: 420x385x1500mm				

## FLOOR DISPLAY



PROMO SHOP CONFIGURATIONS

\*mm



REF 10.108

1165

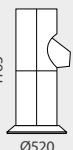

REF 10.109

1165

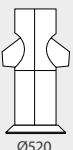

REF 10.102

1715

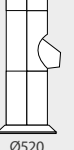

REF 10.103

1715

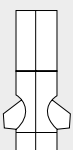

REF 10.104

1715

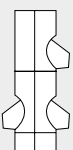

REF 10.105

1715



REF 10.106

SECTIONS ARTWORK

\*mm

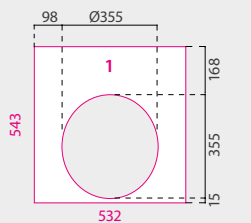
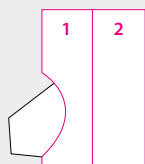

TOTAL GRAPHIC

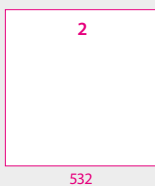

INFORMATION

This merchandiser stand is made of injected plastic and features an easy configuration to set-up. It allows personalization with graphs and a personal configuration, choosing the number of dispensers that require your needs. It is perfect as eye-catching point of purchase presentation at any store.

PROMO SHOP STANDARD GRAPHIC SIZE

PROMO SHOP	STANDARD GRAPHIC SIZE
10.108	Promo Shop ½
10.109	Promo Shop 1
10.102	Promo Shop 2
10.103	Promo Shop 3
10.104	Promo Shop 4
10.105	Promo Shop 5
10.106	Promo Shop 6

PROMO SHOP



DISPLAY DETAILS



DIMENSIONS

\*mm

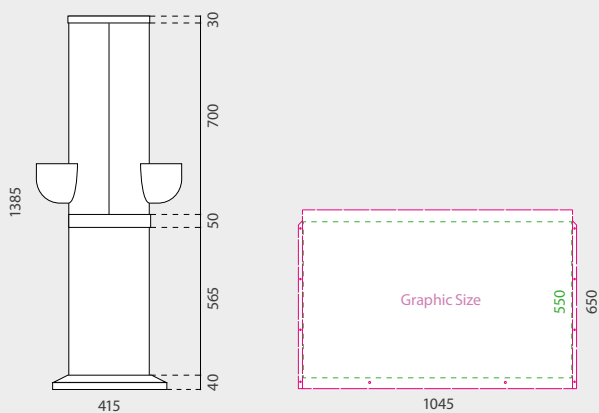

INFORMATION

This fully removable merchandising display features 2 dispensers made of plastic and a transparent divided cylinder for the exhibition of 2 classes of products. Also it is available in blue or red color and the base allows the customization with graphic. This Dispenser Display is light weight and easy to set-up. The Promo Store is ideal for the exhibition of toys, candies, cosmetics, merchandising, samples, gifts or last minute add-on items at playstores, malls, shops, etc...

P.STORE	QTY	N.W	G.W	C.B.M	SIZE
Packing	1	2.58kg	3.93kg	0.1762	450x440x880mm
10.110		Graphic Size: 1045x650mm			

PROMO STORE



DISPLAY DETAILS



DIMENSIONS

\*mm

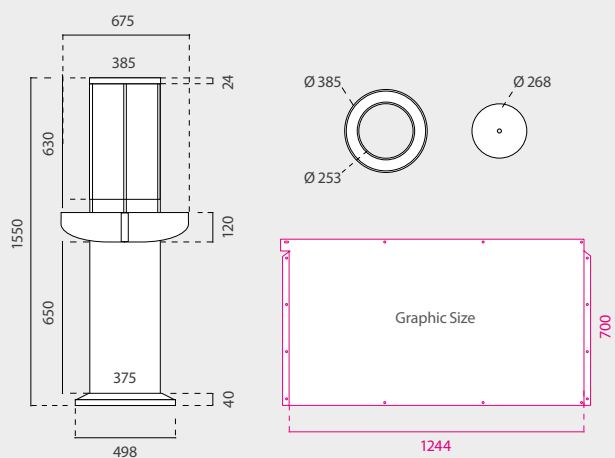

INFORMATION

This dispenser features a 675mm diameter plastic hemisphere. It allows personalization with graphic and is fully removable. Thanks to the easy access to the product, the Promo Bowls are ideal for the exhibition of toys, candies, merchandise, cosmetics, last minute add-on items, merchandising, samples, gifts or last minute add-on items at playstores, malls, shops, etc.

PROMO BRAND	GRAPHIC SIZE
10.429	1244x700mm

PROMO BRAND



## BOWL DETAILS

## INFORMATION

\*mm

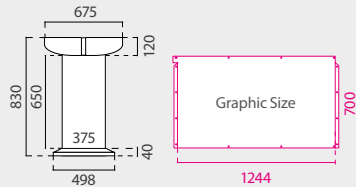

This merchandiser features a  $\text{Ø}675\text{mm}$  plastic semisphere. It allows to be customized with a graphic (the printing service is available but not included).

PROMO CASH

GRAPHIC SIZE

13.468

1244x700mm

## PROMO CASH



## BOWL DETAILS

## INFORMATION

\*mm

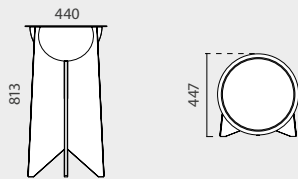

This merchandiser with lightweight wooden base features a  $\text{Ø}440\text{mm}$  transparent polycarbonate semisphere. Ideal for the exhibition of last minute add-on items.

W.P.BOWL	QTY	N.W	G.W	C.B.M	SIZE
Semisphere	1	0.75kg	1.85kg	0.0561	492x485x235mm
Wood Base	1	4.95kg	5.75kg	0.0196	900x435x50mm
13.481		Natural Wood			

## WOODEN PROMO BOWL



## BOWL DETAILS

## INFORMATION

\*mm

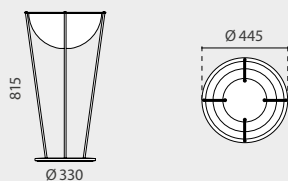

This merchandiser with aluminium base features a  $\text{Ø}440\text{mm}$  transparent polycarbonate semisphere. Great visibility for the exhibition of products.

A.P.BOWL	QTY	N.W	G.W	C.B.M	SIZE
Semisphere	1	1.15kg	2.35kg	0.0561	492x485x235mm
Base	1	5kg	5.3kg	0.0055	350x350x45mm
50.383		Semisphere: $\text{Ø}445\text{mm}$   Base: $\text{Ø}330\text{mm}$			

## ALUMINIUM PROMO BOWL



## BOWL DETAILS



## DIMENSIONS

\*mm

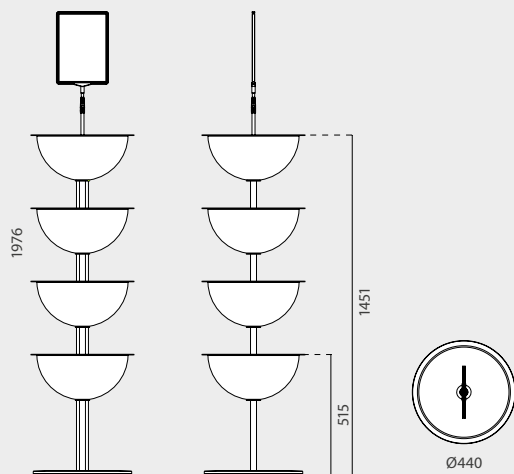

## INFORMATION

This merchandising multi-bowl is ideal for displaying the last minute add-on items thanks its 440mm diameter semispheres made of transparent polycarbonate. Adding 4 Bowls semispheres for the exhibition of more varieties of product. It features an 8 kg metallic base and includes a frame kit. Perfect for exhibition of candies, cosmetics, hair accessories, and much more.

P.BOWL	QTY	N.W	G.W	C.B.M	SIZE
Semisphere	1	2.95kg	3.95kg	0.0714	454x455x345mm
Base+Profile	1	9kg	10kg	0.0714	455x455x345mm
10.802		Semisphere: Ø440mm			

## PROMO BOWL





## DUMPBIN DETAIL

## DIMENSIONS

\*mm

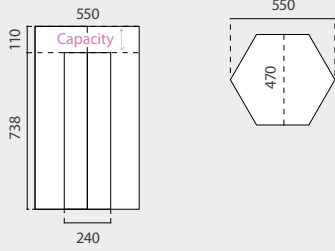

## INFORMATION

This white coated cardboard dumpbin is very lightweight (only 1.35 kg) and fast to set-up. It's ideal for getting the attention of the customers. Accra's design bets more on product display, allowing a faster access and business output.

ACCRA	QTY	N.W	G.W	C.B.M	SIZE
Packing	1	1.35kg	2kg	0.018	830x25x910mm
13.466					550x470x848mm

## ACCRA



## DUMPBIN DETAIL

## DIMENSIONS

\*mm

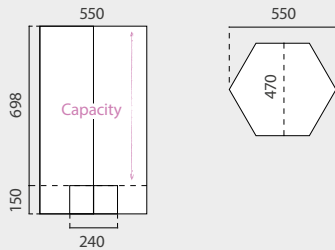

## INFORMATION

This white coated cardboard dumpbin is lightweight (only 1.35 kg), also it is fast to assemble. It's ideal for getting the attention of the customers. Lagos' design, thanks to its great capacity, bet more for the storage of the products.

LAGOS	QTY	N.W	G.W	C.B.M	SIZE
Packing	1	1.35kg	2kg	0.018	830x25x910mm
13.467					550x470x848mm

## LAGOS



## DUMPBIN DETAIL

## DIMENSIONS

\*mm

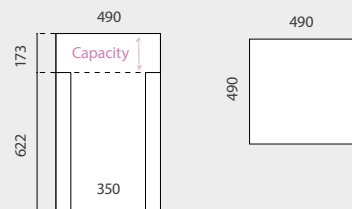

## INFORMATION

This white coated cardboard dumpbin is very light weight (only 1.15 kg) and also it is fast to set-up. It's ideal for getting the attention of the customers. Berna's design bets more on product display, allowing a faster access and business output.

BERNA	QTY	N.W	G.W	C.B.M	SIZE
Packing	1	1.15kg	1.8kg	0.0255	850x30x1000mm
10.732					490x490x795mm

## BERNA



\* the filmstrip at this page is available but not included

## PODIUM DETAILS

\*mm



## PODIUM SET UP

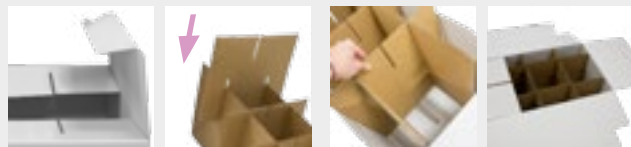

## INFORMATION

## DIMENSIONS

\*mm

This cardboard podium stand has a white finish so it is ideal for customizing with your own graphics. It is very lightweight and also very easy to set-up. Its folding design allows to generate a stable platform with a perfectly sealed appearance for promoting. So it's perfect as Eye-catching advertisement for products promoting at points of sale, retail stores, malls, shopping markets or as an exhibitor display to get the attention of the customers.

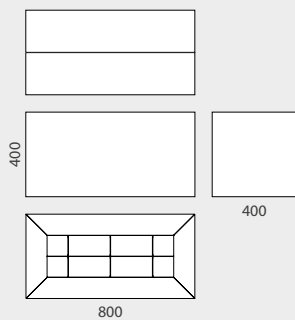

PODIUM	QTY	N.W	G.W	C.B.M	SIZE
Packing	1	2.15kg	3.15kg	0.051	1225x1040x40mm
13.729		400x800x400mm			

## PROMOTIONAL PODIUM STAND



## DISPLAY DETAILS

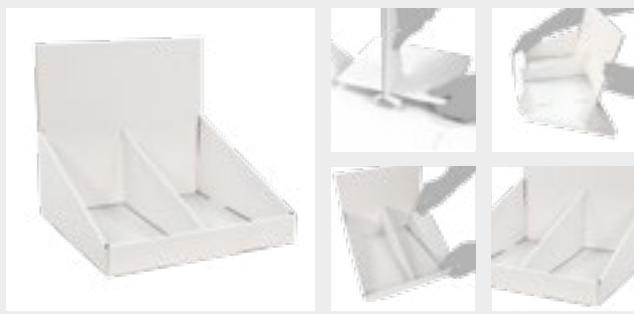

## DIMENSIONS

\*mm

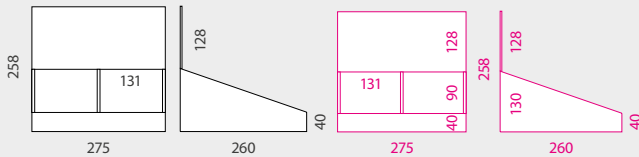

## INFORMATION

Burdeos is a Lightweight and white coated display made of 1.5mm thickness cardboard. Easy and fast set up. The removable divider allows 1 or 2 spaces for exhibition. Ideal as eye-catching point of purchase presentation on any counter.

BURDEOS	QTY	N.W	G.W	C.B.M	SIZE
Packing	5	1.1kg	1.44kg	0.0123	570x500x50mm
10.868	275x260x258mm			x5	

## BURDEOS



## DISPLAY DETAILS



## DIMENSIONS

\*mm

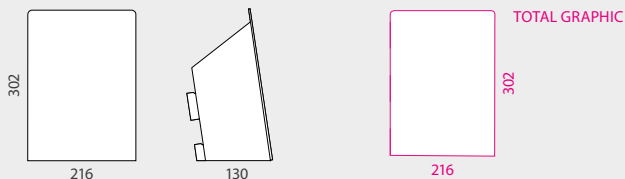

## INFORMATION

Budapest is a lightweight and white coated display made of 1.5mm thickness cardboard. Ideal for displaying last minute add-on items, for customers to purchase as they are checking out. Hooks and printing is available but not included.

BUDAPEST	QTY	N.W	G.W	C.B.M	SIZE
Packing	5	0.525kg	0.7kg	0.0038	260x35x415mm
10.831	Graphic size: 216x302mm			x5	

## BUDAPEST



# TURNTABLES Turntables

Rotary and pendulum 360° motors for product exhibition.  
Different loads and features (LED, solar batteries, etc...).

## ROTARY DETAILS



## INFORMATION

This white colored Turntable has a Ø410mm plate and a loading capacity of ±20kg.

## DIMENSIONS

\*mm

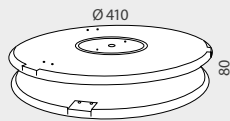

TURN Ø410	QTY	N.W	G.W	C.B.M	SIZE
Packing	1	1.9kg	2.15kg	0.015	420x90x420mm
10.987		Ø410x80mm			

## TURNTABLE ±20kg | Ø410mm



## ROTARY DETAILS



## INFORMATION

\*mm

This Turntable has a Ø200mm plastic flange and a loading capacity of ±20kg. It works directly plugged in.

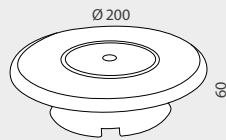

TURN Ø200	QTY	N.W	G.W	C.B.M	SIZE
Packing	1	0.75kg	0.9kg	0.0048	225x75x285mm
10.986		Ø200x60mm			

## TURNTABLE ±20kg | Ø200mm



## ROTARY DETAILS



## INFORMATION

\*mm

This white colored Turntable has a Ø130mm plate and a loading capacity of ±3kg. It works directly plugged in.

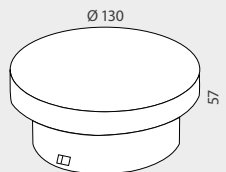

TURN Ø130	QTY	N.W	G.W	C.B.M	SIZE
Packing	1	0.4kg	0.5kg	0.0025	150x70x240mm
10.518		Ø130x57mm			

## TURNTABLE ±3kg | Ø130mm



# TURNTABLES Turntables

## DISPLAY DETAIL

## INFORMATION

\*mm



This Solar Pendulum Display has a loading capacity of  $\pm 5g$ . It works with solar power.

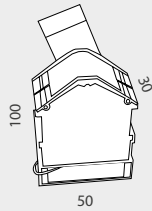

S.PENDULUM	QTY	N.W	G.W	C.B.M	SIZE
Packing	1	0.04kg	0.05kg	0.0002	55x30x105mm
10.358		100x50x30mm			

## SOLAR PENDULUM DISPLAY $\pm 5g$



## DISPLAY DETAIL

## INFORMATION

\*mm



This Pendulum Display has a loading capacity of  $\pm 14g$ . It works with 2 AA batteries (not included).

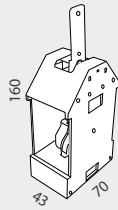

B.PENDULUM	QTY	N.W	G.W	C.B.M	SIZE
Packing	1	0.11kg	0.14kg	0.0006	75x50x165mm
10.063		160x70x43mm			

## BATTERY PENDULUM DISPLAY $\pm 14g$



## TURNTABLE DETAIL

## INFORMATION

\*mm



This  $\varnothing 85mm$  Turntable has a loading capacity of  $\pm 200g$ . It works with 1 AA battery (not included).

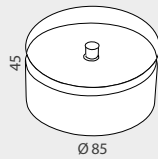

B.TURNTABLE	QTY	N.W	G.W	C.B.M	SIZE
Packing	1	0.12kg	0.15kg	0.0001	95x89x125mm
10.406		$\varnothing 85x45mm$			

## BATTERY TURNTABLE $\pm 200g$ | $\varnothing 85mm$



## TURNTABLE DETAIL

## INFORMATION

\*mm



This Turntable has a loading capacity of  $\pm 200g$ . It works with solar power.

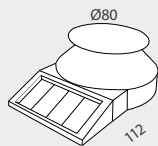

S.TURNTABLE	QTY	N.W	G.W	C.B.M	SIZE
Packing	1	0.08kg	0.1kg	0.0004	85x45x115mm
10.064		112x80x43mm			

## SOLAR TURNTABLE $\pm 200g$



## TURNTABLE DETAILS





## INFORMATION

\*mm

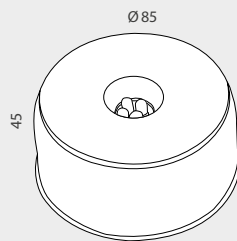
This Turntable has a  $\varnothing 85$ mm plate and a loading capacity of  $\pm 2$ kg. It also features interior lighting with 4 LEDs (included). It works directly plugged in or with batteries. 2 colors available.



B.TURN 2KG $\varnothing 85$	QTY	N.W	G.W	C.B.M	SIZE
Packing	1	0.3kg	0.35kg	0.002	125x75x190mm
10.407	 	$\varnothing 85 \times 45$ mm			

## BATTERY TURNTABLE

$\pm 2$ kg |  $\varnothing 85$ mm



## TURNTABLE DETAILS



## INFORMATION

\*mm

This Turntable has a  $\varnothing 120$ mm plate and a loading capacity of  $\pm 2.5$ kg. It also features interior lighting with 4 LEDs (included). It works with batteries or directly plugged in (turntable function only works plugged in).

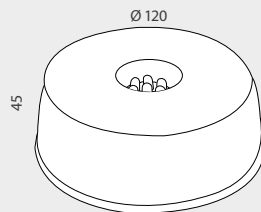

B.TURN 2KG $\varnothing 120$	QTY	N.W	G.W	C.B.M	SIZE
Packing	1	0.4kg	0.45kg	0.0013	127x55x197mm
10.456	$\varnothing 120 \times 45$ mm				

## BATTERY TURNTABLE











$\pm 2$ kg |  $\varnothing 120$ mm

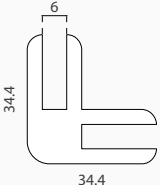





## PIECES DETAIL \*mm











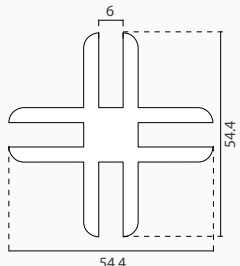

### "L" SHAPE \*mm

"L" SHAPE	COLOR		
15.182		x4 	
15.183		x4 	
15.184		x4 	
15.185		x4 	
15.186		x4 	

### "T" SHAPE \*mm

"T" SHAPE	COLOR		
15.187		x4 	
15.188		x4 	
15.189		x4 	
15.190		x4 	
15.191		x4 	

### "X" SHAPE \*mm

"X" SHAPE	COLOR		
15.192		x4 	
15.193		x4 	
15.194		x4 	
15.195		x4 	
15.196		x4 	

## CUBE SYSTEM



## STAND DETAILS



## INFORMATION

This transparent Stand is made of 3mm thickness acrylic. So it is ideal for displaying books, Dvd, videogames, etc... It is an excellent addition to book stores, malls, jewelry, sport stores or personal collection. 2 size models of Book Stand are available.

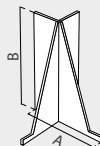

BOOK STAND	SIZE AxB	THICKNESS		
50.377	135x200mm	3mm	x5	
50.378	115x150mm	3mm	x5	

## ACRYLIC BOOK STAND



## STAND DETAILS



## INFORMATION

\* mm

This stand for brochures is made of 3mm thickness acrylic and features 2 sizes available. This Brochure Stand is great for the exhibition of books, pamphlets or flyers...

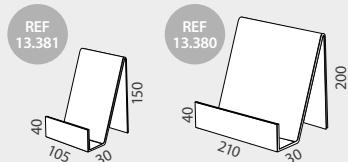

BROCHURE S.	SIZE	THICKNESS		
13.380	210x200x40mm	3mm	x5	
13.381	105x150x40mm	3mm	x5	

## ACRYLIC LITERATURE STAND







## STAND DETAILS

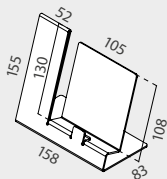

## INFORMATION

This transparent stand for phones or pad/tablets is made of 2mm thickness acrylic and features a graphic holder (140x50mm) ideal for displaying the information of the device. This Phone/Pad Stand is great for malls and electronics or telephone stores.



PAD/PHONE S.	QTY	N.W	G.W	C.B.M	SIZE	
Packing	1	0.19kg	0.39kg	0.0086	320x235x115 mm	Thickness
13.562		Label Size: 140x50mm		x2		2mm

## ACRYLIC PAD/PHONE STAND

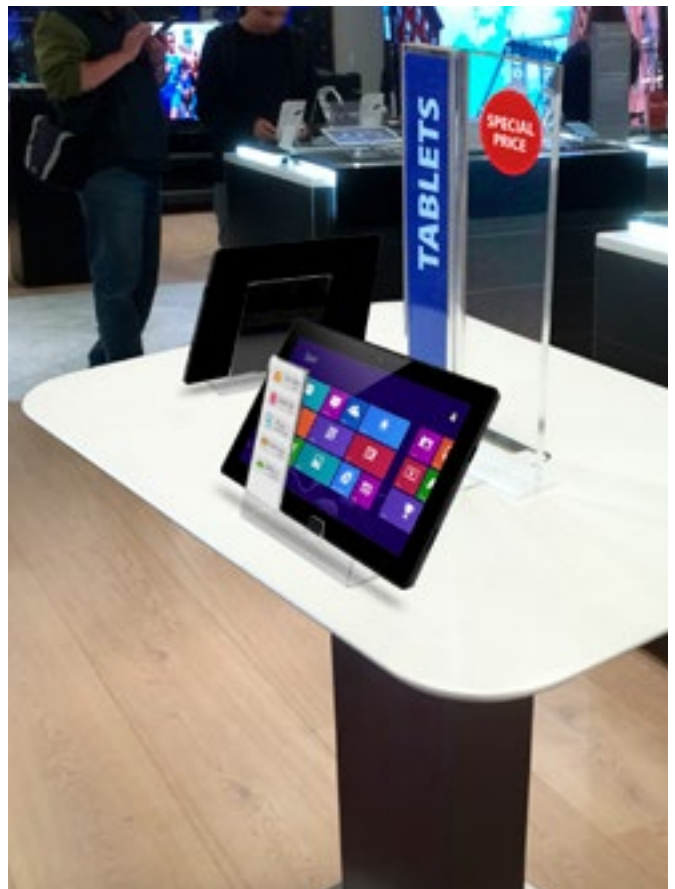

## STAND DETAILS



## INFORMATION

\* mm

This Monitor stand is made of 10mm thickness acrylic and features a flat surface of 547x251mm. Ideal to keep the worktable tidy and get an additional desk for the keyboard or the computer.

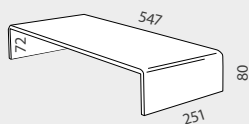

MONITOR S.	SIZE	THICKNESS	
50.380	547x251x80mm	10mm	x1

## ACRYLIC MONITOR STAND



## STAND DETAILS



## INFORMATION

\* mm

This stand is made of 3mm thickness acrylic. The "U" stand is ideal for displaying some smaller products at different levels. It is an excellent addition to any retail store or for a personal collection.

REF 50.308

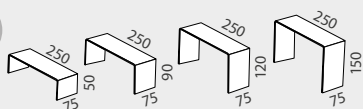

REF 50.309

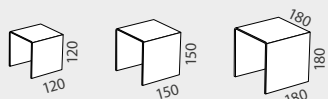

"U" SHAPED	SIZE	THICKNESS	
50.308	250x150x75mm	3mm	Set of 4

"U" SHAPED	SIZE	THICKNESS	
50.309	180x180x180mm	3mm	Set of 3

## ACRYLIC "U" STAND



## STAND DETAILS



## DIMENSIONS

\*mm

REF  
50.306

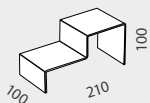

REF  
50.307

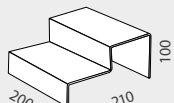

## INFORMATION

This stand is made of 3mm thickness acrylic. So it is ideal for displaying some smaller promotional products at different levels, so it is an excellent addition to any retail store or personal collection for the exhibition of products.

2 STEPS	SIZE	THICKNESS	
50.306	100x100x210mm	3mm	x5
2 STEPS	SIZE	THICKNESS	
50.307	200x100x210mm	3mm	x5

## ACRYLIC 2 STEPS STAND



## STAND DETAILS

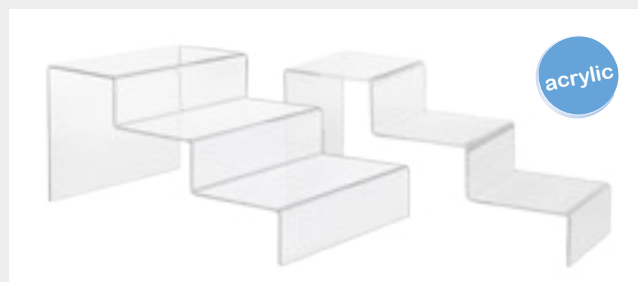

## DIMENSIONS

\*mm

REF  
50.304

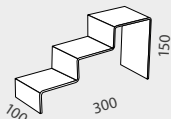

REF  
50.305

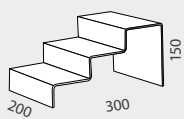

## INFORMATION

This stand is made of 3mm thickness acrylic. So it is ideal for displaying some smaller promotional products at different levels, so it is an excellent addition to any retail store or personal collection. 2 sizes of display available.

3 STEPS	SIZE	THICKNESS	
50.304	100x150x300mm	3mm	x5
3 STEPS	SIZE	THICKNESS	
50.305	200x150x300mm	3mm	x5

## ACRYLIC 3 STEPS STAND



## STAND DETAILS



## INFORMATION

\* mm

This stand is made of 3mm thickness acrylic. The Podium stand is ideal for displaying some smaller products at different levels. It is an excellent addition to any retail store or for a personal collection.

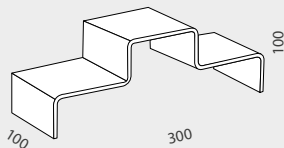

PODIUM	SIZE	THICKNESS	
50.303	100x100x300mm	3mm	x5 

## ACRYLIC PODIUM STAND



## STAND DETAILS



## INFORMATION

\* mm

This stand is made of 3mm thickness acrylic. The circular stand is ideal for displaying some smaller promotional products at different levels. An excellent addition to any retail store or personal collection. Sets of 4 pieces.

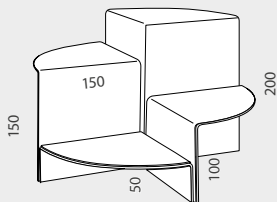

CIRCULAR S.	SIZE	THICKNESS	
50.334	Ø 300x200mm	3mm	Set of 4

## ACRYLIC CIRCULAR STAND



## STAND DETAILS

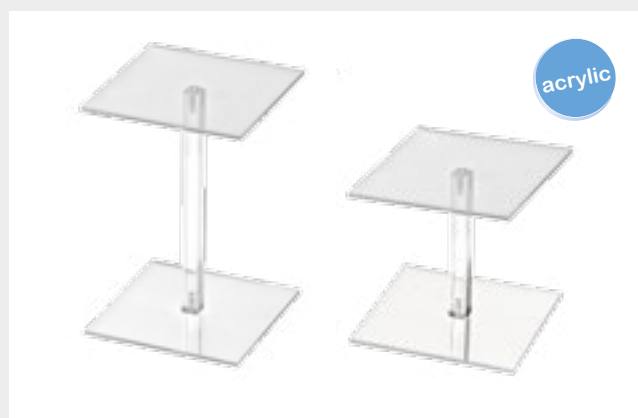



## INFORMATION

\* mm

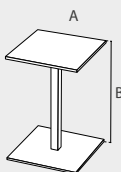
This Pedestal is made of 3mm thick acrylic. It is an excellent addition to any retail store or personal collection. With 2 sizes available.



PEDESTAL	SIZE AxB	THICKNESS		
50.310	100x150mm	3mm	x5	
50.311	100x100mm	3mm	x5	

## ACRYLIC PEDESTAL STAND



## STAND DETAILS



## DIMENSIONS

\*mm

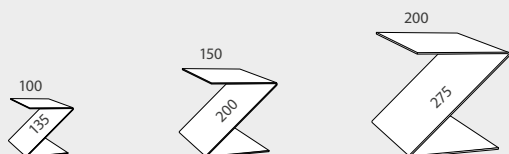

## INFORMATION

This stand is made of 3mm thickness acrylic. The "Z" stand is ideal for displaying some smaller promotional products at different levels. An excellent addition to any retail store or personal collection. Sets of 3 pieces.

"Z" SHAPED	EXTERNAL SIZE SET	THICKNESS		
50.335	200x200x200mm	3mm	Set of 3	

## ACRYLIC "Z" STAND



## STAND DETAILS



## INFORMATION

This stand is made of 2mm or 3mm thickness acrylic (depending on model). So it is ideal for displaying some smaller promotional products at different levels, so it is an excellent addition to any retail store or personal collection. There are 4 sizes of "X" Stand available.

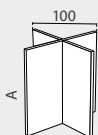

"X" SHAPED	SIZE	THICKNESS		
50.373	100x100xA25mm	2mm	x5	
50.372	100x100xA75mm	3mm	x5	
50.371	100x100xA100mm	3mm	x5	
50.370	100x100xA150mm	3mm	x5	

## ACRYLIC "X" STAND



## STAND DETAILS

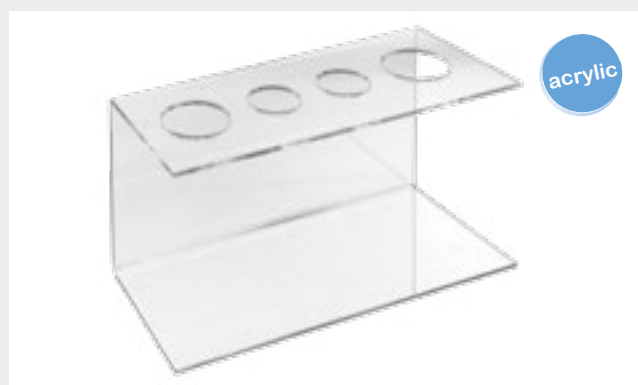

## INFORMATION

\* mm

This Podium is made of 3mm thickness acrylic. It is ideal for displaying ice cream cones or promotional items, so it is an excellent addition to any ice cream shop or personal collection.

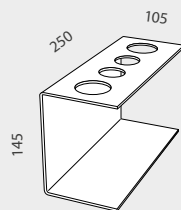

I.C. STAND	SIZE	THICKNESS		
50.336	250x145x105mm	3mm	x5	

## ACRYLIC ICECREAM STAND



## STAND DETAILS



## DIMENSIONS

\* mm

REF 50.323

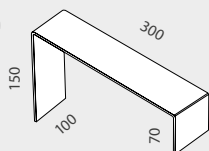

REF 50.322

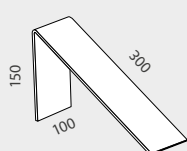

## STAND DETAILS



## DIMENSIONS

\* mm

REF 50.300

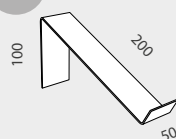

REF 50.302

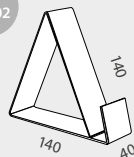

REF 50.301

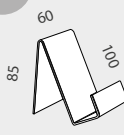

## INFORMATION

This transparent Glorifier Stand is made of 2mm thickness acrylic. It is ideal for displaying smaller products, such as shoes, books, Dvd, videogames, etc... It is an excellent addition to book stores, malls, jewelry, sport stores or personal collection. Several angles and 5 models of Easel Stand are available.

GLORIFIER	SIZE	THICKNESS		
50.301	100x60x85mm	2mm	x10	
50.302	140x40x140mm	2mm	x6	
50.300	200x50x100mm	2mm	x10	
50.322	300x100x150mm	2mm	x10	
50.323	300x100x150mm	2mm	x10	

## ACRYLIC GLORIFIER STAND





### STAND DETAILS

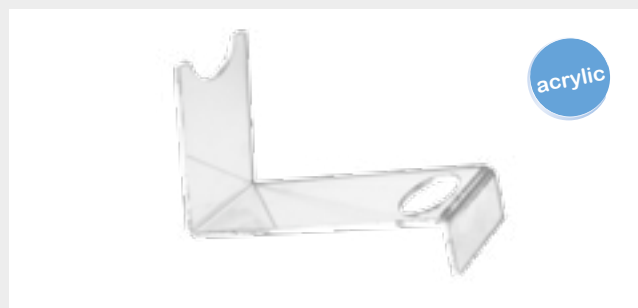

### INFORMATION

\* mm

This Bottle Stand is made of 5mm thickness acrylic. It is transparent and 220mm length and it is ideal for displaying bottles or cilindric items, so this acrylic stand is an excellent addition to any supermarket, wine store, retail store or just for a personal display vollection.

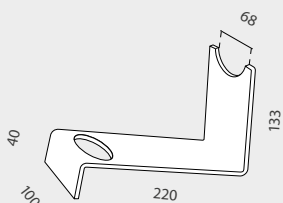

BOTTLES	SIZE	THICKNESS	
50.332	100x133x220mm	5mm	x5

## ACRYLIC BOTTLE STAND



### STAND DETAILS



### INFORMATION

\* mm

This transparent "Steps" Stand is made of 3mm thickness acrylic. It is ideal for displaying small objets, such as cans. It is an excellent addition to retail stores or markets.

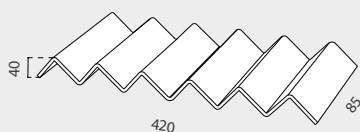

MOUNTAIN S.	SIZE	THICKNESS	
50.337	420x85x40mm	3mm	x5

## ACRYLIC STEPS STAND





## STAND DETAILS



## INFORMATION

\* mm

This display features a transparent hand shape and it is made of 3mm thickness acrylic. It is suitable for displaying rings or gloves. Ideal for being used on window shops.

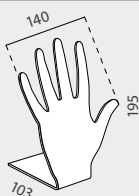

HAND	SIZE	THICKNESS	
50.326	195x140x103mm	3mm	x5

## ACRYLIC HAND STAND



## STAND DETAILS



## INFORMATION

\* mm

This transparent stand is made of 3mm thickness acrylic. It is ideal for displaying bracelets or jewelry. Ideal for being used on window shops and it is an excellent addition to any retail store or just for personal collection.

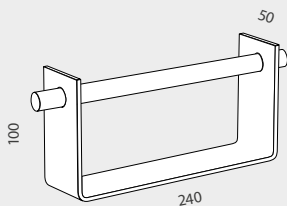

BRACELET S.	SIZE	THICKNESS	
50.315	240x100x50mm	3mm	x1

## ACRYLIC BRACELET STAND



## STAND DETAILS



## INFORMATION

\* mm

This transparent display features a "Neck-bust" shape and it is made of 3mm thickness acrylic. This display is suitable for showing necklaces or pendants. Ideal for displaying on window shops.

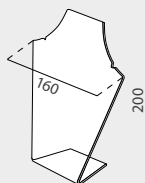

NECKLACE S.	SIZE	THICKNESS		
50.312	200x160mm	3mm	x5	

## ACRYLIC NECKLACE STAND

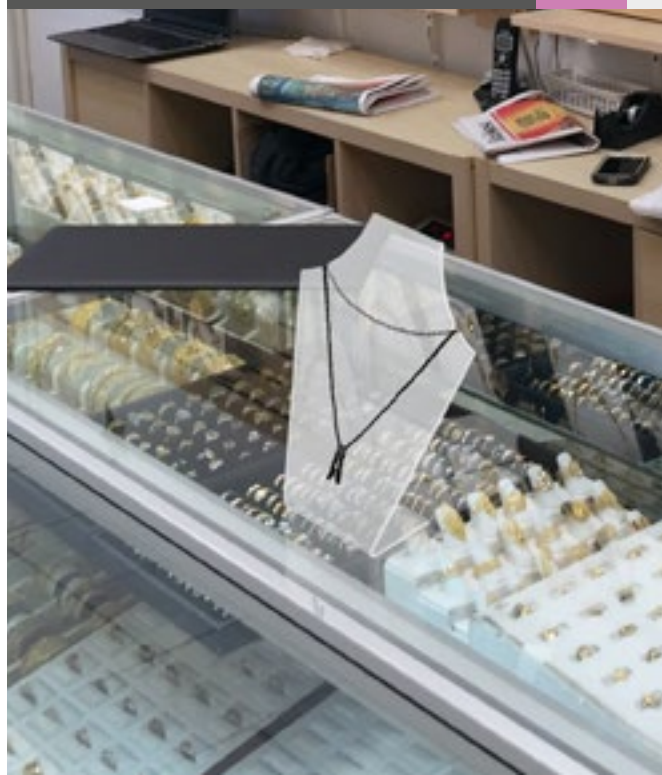

## STAND DETAILS

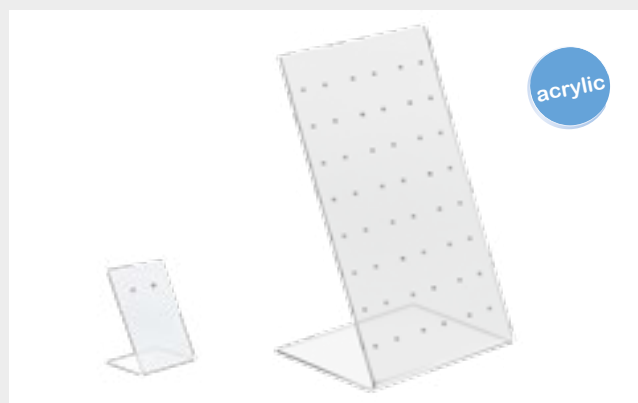



## INFORMATION

\* mm

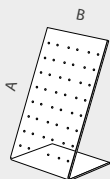
This transparent display features an "L" shape and it is made of 3mm thickness acrylic. Suitable for displaying earrings. Ideal for being used on window shops.



EARRINGS S.	SIZE AxB	THICKNESS		
50.316	220x120mm	3mm	x5	
50.317	60x50mm	3mm	x5	

## ACRYLIC EARRING STAND



## STAND DETAILS

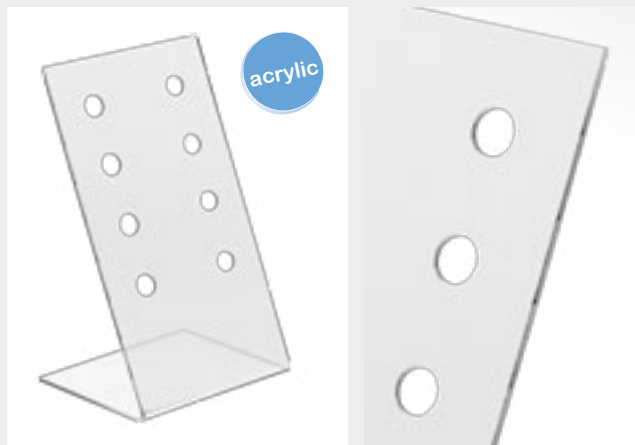

## INFORMATION

\* mm

This display features an "L" shape suitable for show glasses. Ideal for displaying on window shops.

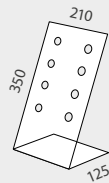

GLASSES S.	SIZE	THICKNESS	
50.324	350x210x125mm	3mm	x5 

## ACRYLIC GLASSES STAND

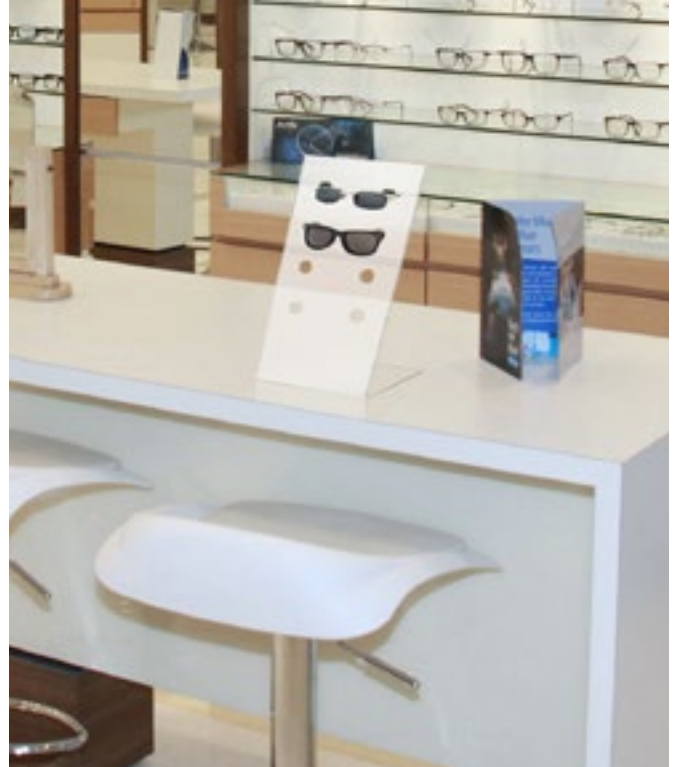

## STAND DETAILS



## INFORMATION

\* mm

This "L" shaped mirror stand features an A4 format mirror with 2.5mm thickness, which can be labelled with logos. This stand is ideal for being used in optical stores, in jeweller's, at hairdresser or wherever the customer can get a unique and custom last impression.

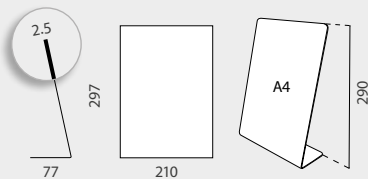

"L" MIRROR	QTY	N.W	G.W	C.B.M	SIZE
Packing	1	0.98kg	1.39kg	0.0158	365x160x270 mm
13.573					x4 

## "L" A4 PORTRAIT MIRROR STAND



# DISPLAY STANDS Display Stands

## DISPLAY DETAILS

\*mm



## INFORMATION

This stand feature 3 hooks for hanging or exhibiting handbags. Its height of 1 m makes it suitable for both handbags and shoulder bags. The stylish black colour finish, making it ideal for any restaurant or retail store.

HANDBAG STAND	QTY	N.W	G.W	C.B.M	SIZE
Pole	1	0.85kg	1.15kg	0.0182	1045x140x125mm
Base	1	2.85kg	3.01kg	0.0024	310x310x25mm
<b>13.848</b>		Size base: Ø300mm		Height: 1010mm	



## HANDBAG STAND



## STAND DETAILS

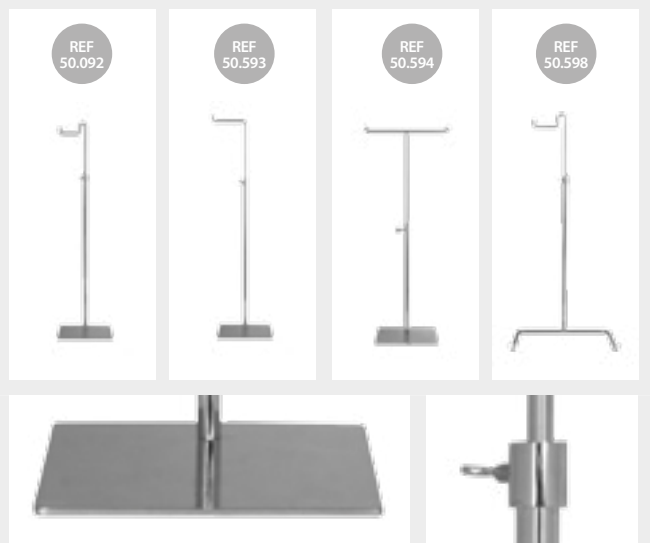

## DIMENSIONS

\*mm

These Handbag Displays Stand feature single or double hooks for using on countertops. With adjustable height from 273 to 580mm (depending on model).

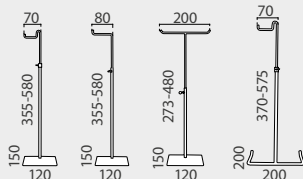

HANDBAG	SIZE BASE	HEIGHT	
50.092	120x150mm	355-580mm	x5 
50.093	120x150mm	355-580mm	x5 
50.094	120x150mm	273-480mm	x5 
50.098	200x200mm	370-575mm	x5 

## HANDBAG DISPLAY



# CARDBOARD

Complete range of cardboard displays and accessories which provide an integral solution for the exhibition at stores or business presentations.

- 448** CARDBOARD COUNTER
- 451** CARDBOARD STOOL
- 452** CARDBOARD LECTERN
- 453** CARDBOARD DISPLAY
- 459** CARDBOARD COMPLEMENTS
- 461** BROCHURE CARDBOARD HOLDER
- 464** CARDBOARD EASELS
- 466** CARDBOARD ACCESSORIES



## COUNTER DETAILS



## INFORMATION

\*mm

Praga Counter is very lightweight and exhibitors can quickly assemble it in less than 5 minutes (no tools required). Fully removable. This counter has a header of 700x300mm (with PVC bars) for displaying company logos or graphs. Each counter that comes with a header is excellent for tradeshows, points of sale, promotional acts in malls or as a display to advertise your business in any exhibition or tradeshow.

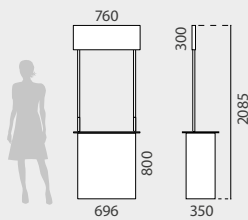

PRAGA	QTY	N.W	G.W	C.B.M	SIZE
Packing	1	3.05kg	3.9kg	0.0443	920x45x1070mm
10.730		696x350x2085mm			

## PRAGA COUNTER



## COUNTER DETAILS



## INFORMATION

\*mm

This counter is assembled in less than 5 minutes. It has an inner space at the bottom of the counter, so the extra brochures, business cards and pencils can be stored out of sight so your exhibition always appears clean and organized. Ideal for points of sale, promotional acts in malls or as a counter to advertise your business in for any exhibition or tradeshow.

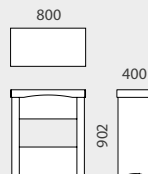

INZA	QTY	N.W	G.W	C.B.M	SIZE
Packing	1	1.8kg	2.8kg	0.0569	1055x980x55mm
13.750		800x400x902mm			

## INZA COUNTER



## DESK DETAILS



## INFORMATION

\*mm

This Counter Desk features the white color with the corrugated natural cardboard for a stylish finish. Also has a strong and stable design with an inner shelf for storing, also it has front-back/sides spaces for placing your own logo or graphic. Ideal for being used as a meeting point at exhibition acts, at events to promote your business or just as a side table at your home.

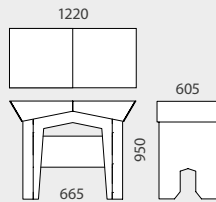

CALI	QTY	N.W	G.W	C.B.M	SIZE
Packing	1	5.25kg	6.3kg	0.0998	950x75x1400mm
13.728		1220x605x950mm			

## CALI DESK

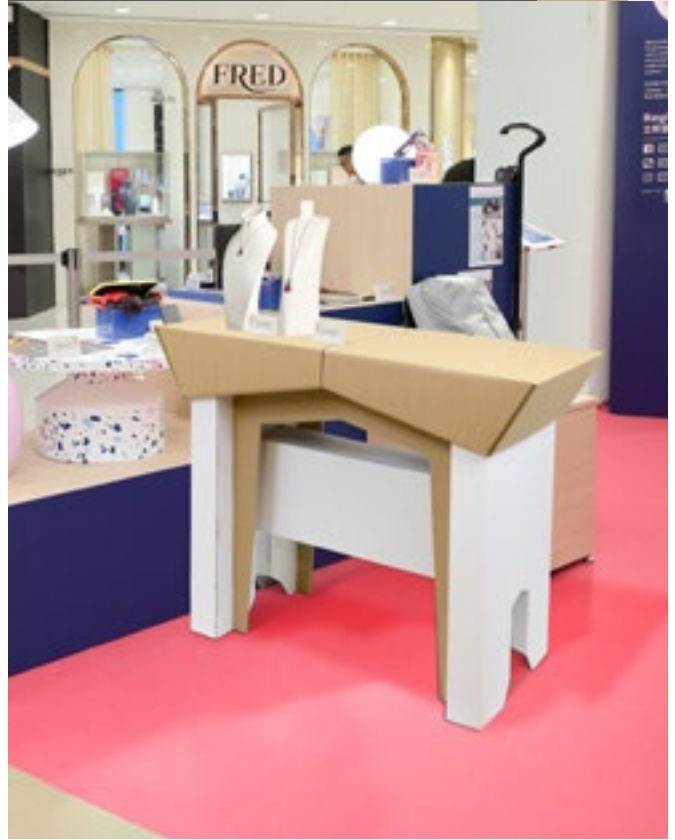

## COUNTER DETAILS



## INFORMATION

\*mm

This Counter features the white color with the corrugated natural cardboard for a stylish finish. Miami is assembled in seconds. It has an inner space at the bottom of the counter, so business cards and pencils can be stored out of sight so your exhibition always appears clean and organized. Ideal for points of sale, promotions in malls or any tradeshow.

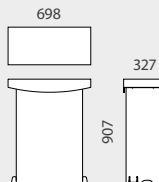

MIAMI	QTY	N.W	G.W	C.B.M	SIZE
Packing	2	2.20kg	3.20kg	0.0510	1225x1040x40mm
13.749		698x327x907mm		x2 	

## MIAMI COUNTER



## COUNTER DETAILS



## DIMENSIONS

## TEMPLATE

\*mm

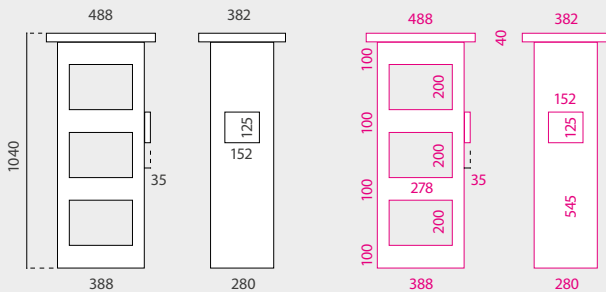

## INFORMATION

This Exhibitor Counter is easy to assemble and lightweight. It is made of 5mm cardboard sheets thickness. It features 4 open shelves which allow customers to easily access product accessories from either side of the corrugated counter. Also, it has 1 brochure holder for promotional documents (left or right placed by the customer). The London Counter ships flat and is easy to assemble with the guidance of the provided instructions. Ideal for being used as an exhibitor or as a counter at points of sale, for tradeshow events, stores or for any temporary promotion.

LONDON	QTY	N.W	G.W	C.B.M	SIZE
Packing	1	1.35kg	2kg	0.0266	425x60x1045mm
10.733					488x382x1040mm

## LONDON





## STOOL DETAILS



## INFORMATION

\*mm

This lightweight oval cardboard stool is assembled in seconds and comes in Kraft color. Also has a strong and stable design. Once folded it can be stored in a minimum space so it is ideal to be added to your meeting point at trade shows, eco-stores, events or for enhancing your office or home spaces.

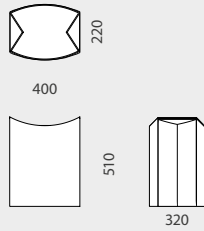

OVAL	QTY	N.W	G.W	C.B.M	SIZE
Packing	4	2.4kg	2.9kg	0.0514	705x90x810mm
13.735	320x400x510mm		x4 		

## OVAL STOOL



## STOOL DETAILS



## INFORMATION

\*mm

This lightweight Kraft color stool is assembled in seconds. With great resistance thanks to its hexagonal base. Once folded it can be stored in a minimum space. Ideal for meeting points at trade shows, eco-stores or for enhancing your office or home spaces. There are 2 heights available.

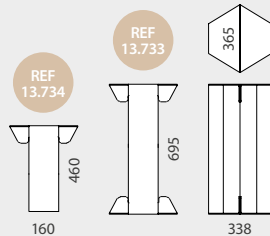

HEX LOW	QTY	N.W	G.W	C.B.M	SIZE
Packing	4	1.6kg	1.93kg	0.0371	535x90x770mm
13.734	338x460x365mm		x4 		
HEX-HIGH	QTY	N.W	G.W	C.B.M	SIZE
Packing	4	2.8kg	3.4kg	0.0612	535x90x1270mm
13.733	338x695x365mm		x4 		

## HEX STOOL





### STAND DETAILS



### INFORMATION

\*mm

Nasau is composed of a single pre-cut and folded corrugated cardboard sheet and a top header. Assembled, it forms a column newspaper rack, the capital making the Lectern. A logo or a text can be printed on the top header. A tab on the lectern can be folded up to hold open books. Ideal for leaflets, magazines, newspapers stores, exhibitions or for meeting points at professional shows and exhibitions.

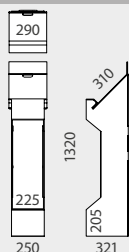

NASAU	QTY	N.W	G.W	C.B.M	SIZE
Packing	2	2kg	3kg	0.051	1225x1040x40mm
13.747	290x321x1320mm			x2	

## NASAU STAND



### DESK DETAILS



### INFORMATION

\*mm

This cardboard Kraft color lectern reading desk features a large inclined surface ideal for displaying large documents and a microphone holder with cable gland at the bottom for the speaker. Also, it has an extra shelf an inner space at the bottom for the extra brochures, business cards or pencils. Ideal for storing newspapers, leaflets, magazines at media events or for meeting points at trade fairs and exhibitions.

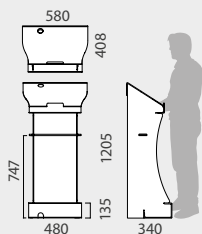

BERMUDA	QTY	N.W	G.W	C.B.M	SIZE
Packing	1	1.7kg	2.7kg	0.051	1225x1040x40mm
13.746	580x340x1205mm				

## BERMUDA DESK



## DISPLAY DETAILS



## DIMENSIONS

## TEMPLATE

\*mm

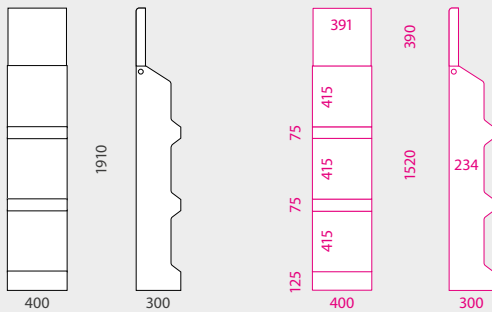

## INFORMATION

The Viena Dispenser is easy to assemble and lightweight (1.1 kg). It is made of 3mm cardboard sheets thickness. It features 3 shelves which allow customers to easily access product accessories. Also, it has 1 upper header which allows to be customized. The Viena Counter ships flat and is easy to assemble with the guidance of the provided instructions. Ideal for being used as an exhibitor at points of sale, retail, stores, promotional acts in supermarkets, as a display to advertise your business in any event tradeshow or for any temporary promotion.

VIENA	QTY	N.W	G.W	C.B.M	SIZE
Packing	1	1.1kg	1.7kg	0.0222	720x20x1540mm
10.734					400x300x1910mm

## VIENA



## STAND DETAILS



## DIMENSIONS

## TEMPLATE

\*mm

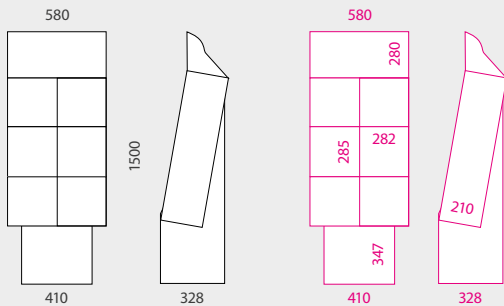

## INFORMATION

Oslo is a very fast to assemble cardboard display with two white coated sides. Also, it is lightweight (2.8 kg). Includes 5mm thick cardboard upper header, 6 shelves displays (1.5mm cardboard's thickness) and a 5mm thick cardboard base. Ideal for using at points of sale, promotional acts in supermarkets or as a display to advertise your business in any event or any exhibition.

OSLO	QTY	N.W	G.W	C.B.M	SIZE
Packing	1	2.8kg	3.9kg	0.2196	820x255x1050mm
10.731		580x328x1500mm			

## OSLO



## STAND DETAILS



## DIMENSIONS

## TEMPLATE

\*mm

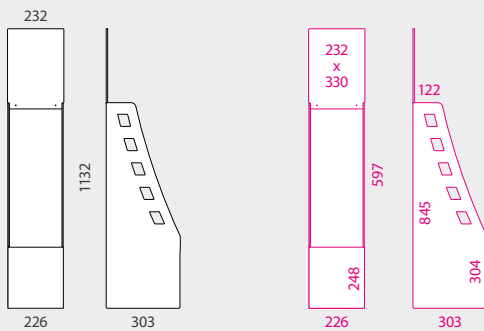

## INFORMATION

This cardboard Brochure Stand is the perfect retail tool for magazine storage and display. Caribe Stand is designed with a shelf support of 219x302mm which is reinforced with a cross-piece for holding a variety of publications. This cardboard magazine holder, also known as a corrugated cardboard literature holder, is perfect for supermarkets, pharmacies, bookstores and more. Customize the Top Header to draw attention to your best selling magazines or literature. This cardboard magazine holder is an affordable alternative to pricier slatwall magazine holder displays.

CARIBE	QTY	N.W	G.W	C.B.M	SIZE
Packing	2	2.8kg	3.67kg	0.0238	900x660x40mm
13.745	226x303x1132mm		x2 		

## CARIBE



## DUMPBIN DETAIL DIMENSIONS \*mm

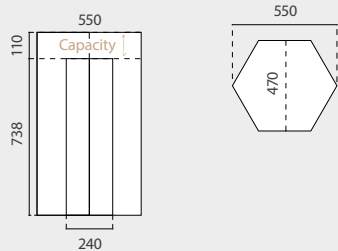

### INFORMATION

This white coated cardboard dumpbin is very lightweight (only 1.35kg) and fast to set-up. It's ideal for getting the attention of the customers. Accra's design bets more on product display, allowing a faster access and business output.

ACCRA	QTY	N.W	G.W	C.B.M	SIZE
Packing	1	1.35kg	2kg	0.018	830x25x910mm
13.466					550x470x848mm

## ACCRA



## DUMPBIN DETAIL DIMENSIONS \*mm

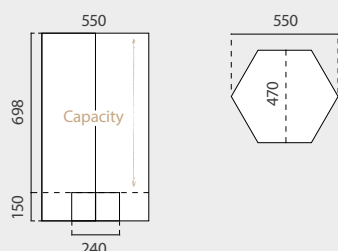

### INFORMATION

This white coated cardboard dumpbin is lightweight (only 1.35 kg), also it is fast to assemble. It's ideal for gettin the attention of the customers. Lagos' design, thanks to its great capacity, bet more for the storage of the products.

LAGOS	QTY	N.W	G.W	C.B.M	SIZE
Packing	1	1.35kg	2kg	0.018	830x25x910mm
13.467					550x470x848mm

## LAGOS



## DUMPBIN DETAIL DIMENSIONS \*mm

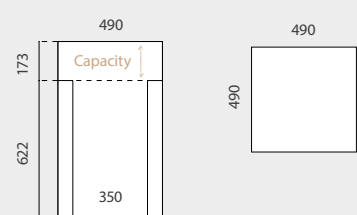

### INFORMATION

This white coated cardboard dumpbin is very light weight (only 1.15 kg) and also it is fast to set-up. It's ideal for getting attention of the customers. Berna's design bets more on product display, allowing a faster access and business output.

BERNA	QTY	N.W	G.W	C.B.M	SIZE
Packing	1	1.15kg	1.8kg	0.0255	850x30x1000mm
10.732					490x490x795mm

## BERNA



\* the filmstrip at this page is available but not included

PODIUM DETAILS



PODIUM SET UP



INFORMATION

This cardboard podium stand has a white finish so it is ideal for customizing with your own graphics. It is very lightweight and also very easy to set-up. Its folding design allows to generate a stable platform with a perfectly sealed appearance for promoting. So it's perfect as Eye-catching advertisement for products promoting at points of sale, retail stores, malls, shopping markets or as an exhibitor display to get the attention of the customers.

DIMENSIONS

\*mm

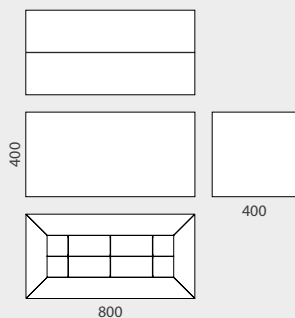

PODIUM	QTY	N.W	G.W	C.B.M	SIZE
Packing	1	2.15kg	3.15kg	0.051	1225x1040x40mm
13.729		400x800x400mm			

PROMOTIONAL PODIUM STAND



## PHOTOCALL DETAILS



## INFORMATION

\*mm

The white finish Fasteasy photocall is ideal for customizing with your own graphics. Inexpensive and durable, this stand features the possibility of joining 2 or more photocalls to create large advertising spaces. Also, we supply this cardboard photocall with easel and plastic screws. It is lightweight, making it easy to transport and also easy to fold for storing.

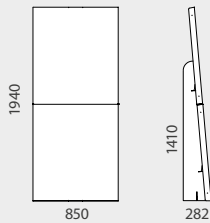

PHOTOCALL	QTY	N.W	G.W	C.B.M	SIZE
Packing	2	3.3kg	4.3kg	0.0569	1055x980x55mm
13.727	850x282x1940mm				x2 

## FASTEASY PHOTOCALL



## SIDEWALK DETAILS



## INFORMATION

\*mm

The Neiva A-Board has a white finish so it is ideal for customizing with your own offers or graphics. It's assembled in seconds. Features a folding design which allows an easy storing. Neiva is perfect as Eye-catching advertisement for products promotion at point of sale, malls, retail stores, shopping markets or as an exhibitor display to get the attention from the customers.

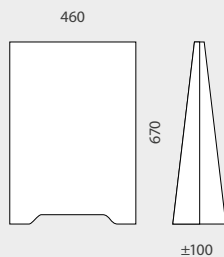

NEIVA	QTY	N.W	G.W	C.B.M	SIZE
Packing	2	1.74kg	2.74kg	0.0569	1055x980x55mm
13.748	460x100x670mm				x2 

## NEIVA SIDEWALK





## CORNER DETAILS



## INFORMATION

\*mm

This corrugated cardboard corner protectors are assembled in seconds and come in Kraft color. Also has a strong and tough design. They are a great solution for the protection and packaging of frame moldings. So they are ideal for safe transporting or storing of pictures.

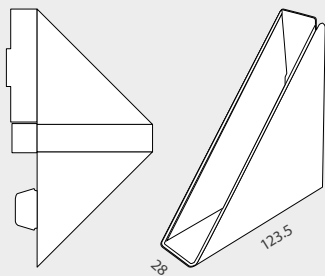

PROTECTORS	QTY	N.W	G.W	C.B.M	SIZE
Packing	50	1.25kg	1.50kg	0.0123	560x490x45mm
13.732	123.5x28x123.5mm				x50 

## CORRUGATED CORNER PROTECTORS



## BIN DETAILS



## INFORMATION

\*mm

This Bin is made from durable corrugated cardboard. Our storage bins do not require staples or tape to assemble as they have an efficient one-piece self-locking construction. Our kraft and white corrugated bin boxes include a write-on space for easy labelling and identification of the stored items. These bins are stored and shipped flat. Perfect for enhancing your office or home space.

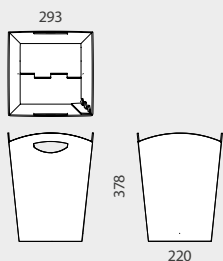

BIN	QTY	N.W	G.W	C.B.M	SIZE
Packing	4	1.67kg	2kg	0.0371	535x90x770mm
13.751	293x293x378mm				x4 

## CARDBOARD BIN



**BOXES DETAILS**

\*mm



**BOXES SET UP**



**DIMENSIONS**

\*mm

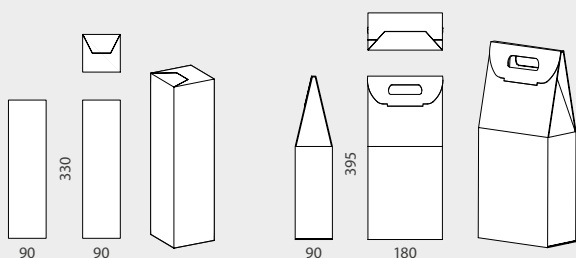

**INFORMATION**

These white coated bottle boxes are designed to enhance the presentation of your products by adding a little luxury to your clients' gifts. Just finish off with your own customization or a gift ribbon. This single white coated 75cl bottle box features a high quality design with upper closer, which will help you transport the bottle upright and without smashes, leaks or the base falling through. The double bottle box model, also features a high quality resisting upper handle for an easy transportation.

1 BOTTLE BOX	QTY	N.W	G.W	C.B.M	SIZE
Packing	10	1kg	1.25kg	0.123	560x490x45mm
13.731	90x330x90mm			x10 	
2 BOTTLES BOX	QTY	N.W	G.W	C.B.M	SIZE
Packing	10	1kg	1.25kg	0.0123	560x490x45mm
13.730	90x395x180mm			x10 	

**WINE BOTTLE  
CARDBOARD BOX**



## A5 HOLDER DETAILS

\*mm

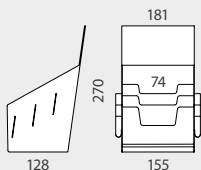

## 1/3 A4 HOLDER DETAILS

\*mm

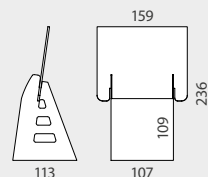

## A5 HOLDER DETAILS

\*mm

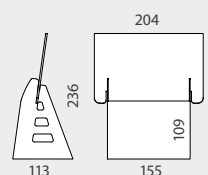



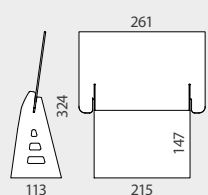

## A4 HOLDER DETAILS

\*mm



## INFORMATION

These Brochure Holders are made of white coated cardboard and are ideal for being used over counter desktop for temporary promotions. The A4, A5 and 1/3 of A4 format models feature a slightly angled back design and high rear supports for a better displaying. The Triple A4 format model features 3 compartments. We provide the cardboard Holders flat, and it requires only a few simple folds to assemble it.

3x A5 D.	QTY	N.W	G.W	C.B.M	SIZE
Packing	10	0.25kg	0.40kg	0.0069	480x360x40mm
<b>13.741</b>	<b>Leaflet size: A5</b>			<b>x10</b>	
1/3 A4 D.	QTY	N.W	G.W	C.B.M	SIZE
Packing	10	0.25kg	0.40kg	0.0069	480x360x40mm
<b>13.742</b>	<b>Leaflet size: 1/3 A4</b>			<b>x10</b>	
A5 DISPENSER	QTY	N.W	G.W	C.B.M	SIZE
Packing	10	0.3kg	0.38kg	0.0069	480x360x40mm
<b>13.744</b>	<b>Leaflet size: A5</b>			<b>x10</b>	
A4 DISPENSER	QTY	N.W	G.W	C.B.M	SIZE
Packing	10	0.60kg	0.75kg	0.0127	655x485x40mm
<b>13.743</b>	<b>Leaflet size: A4</b>			<b>x10</b>	

## CARDBOARD LEAFLET DISPENSER



## HOLDER DETAILS



## DIMENSIONS

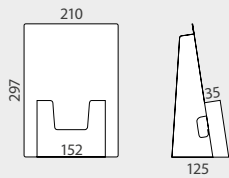

## TEMPLATE

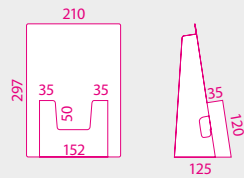

\*mm

## INFORMATION

Belgrado Brochure Holder is made of 1.5mm thickness white coated cardboard. With top header for customizing your presentation. High rear support and slightly angled back design allow increased visibility of the promotions.

BELGRADO	QTY	N.W	G.W	C.B.M	SIZE
Packing	5	0.33kg	0.5kg	0.0034	275x40x310mm
10.881	210x125x297mm		x5 		

## BELGRADO



## BALLOT BOX DETAILS



## INFORMATION

\*mm

Trieste Ballot Box is made of 2mm thickness white coated cardboard. It includes a top header for your presentations. It is ideal for promotional contests, used as suggestion box or just for voting thanks to its 2 sides brochure holders (125x35x152mm each of them).

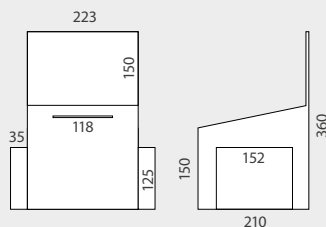

TRIESTE	QTY	N.W	G.W	C.B.M	SIZE
Packing	5	1.25kg	1.55kg	0.0143	570x500x50mm
13.080	223x210x360mm		x5 		

## TRIESTE BALLOT BOX



DISPLAY DETAILS

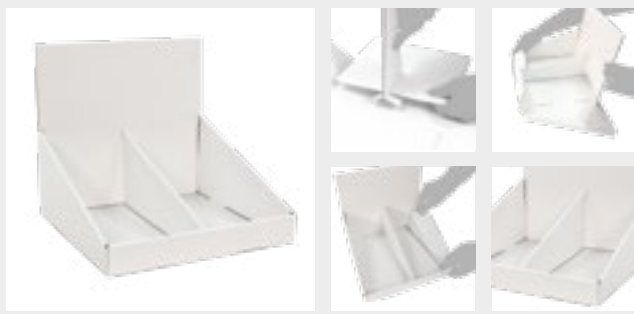

DIMENSIONS

TEMPLATE

\*mm

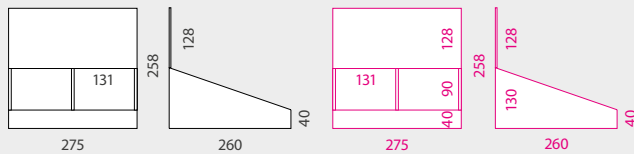

INFORMATION

Burdeos is a Lightweight and white coated display made of 1.5mm thickness cardboard. Easy and fast set up. The removable divider allows 1 or 2 spaces for exhibition. Ideal as eye-catching point of purchase presentation on any counter.

BURDEOS	QTY	N.W	G.W	C.B.M	SIZE
Packing	5	1.1kg	1.44kg	0.0123	570x500x50mm
10.868	275x260x258mm		x5 		

BURDEOS



DISPLAY DETAILS



DIMENSIONS

TEMPLATE

\*mm

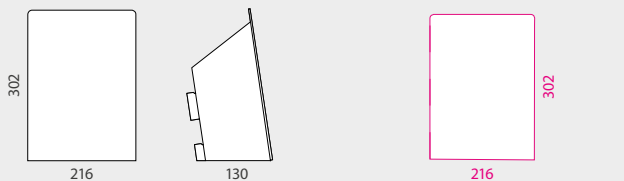

INFORMATION

Budapest is a lightweight and white coated display made of 1.5mm thickness cardboard. Ideal for displaying last minute add-on items, for customers to purchase as they are checking out. Hooks and printing is available but not included.

BUDAPEST	QTY	N.W	G.W	C.B.M	SIZE
Packing	5	0.525kg	0.7kg	0.0038	260x35x415mm
10.831	Graphic size: 216x302mm		x5 		

BUDAPEST



## EASEL DETAILS



## CARDBOARD EASELS

### INFORMATION

- Lightweight
- White coated.
- Fast to assemble.
- 7 sizes available.
- Easy foldable to store.
- Easels are ideal for standing up a display.

## DIMENSIONS

\*mm



## INFORMATION

The Easels are ideal for standing up displays and for creating wall presentations.

EASEL 140	QTY	N.W	G.W	C.B.M	SIZE
	Packing 50	0.37kg	0.45kg	0.0029	170x85x200mm
<b>12.085</b>	<b>Height: 140mm</b>		<b>x50</b> 		

EASEL 275	QTY	N.W	G.W	C.B.M	SIZE
	Packing 50	0.91kg	1.05kg	0.0073	250x85x340mm
<b>12.086</b>	<b>Height: 275mm</b>		<b>x50</b> 		

EASEL 310	QTY	N.W	G.W	C.B.M	SIZE
	Packing 50	0.56kg	0.71kg	0.0056	240x65x365mm
<b>12.115</b>	<b>Height: 310mm</b>		<b>x50</b> 		

EASEL 470	QTY	N.W	G.W	C.B.M	SIZE
	Packing 50	2kg	2.7kg	0.0074	395x310x605mm
<b>12.444</b>	<b>Height: 470mm</b>		<b>x50</b> 		

EASEL 680	QTY	N.W	G.W	C.B.M	SIZE
	Packing 20	1.97kg	2.4kg	0.0171	565x40x760mm
<b>12.116</b>	<b>Height: 680mm</b>		<b>x20</b> 		

EASEL 900	QTY	N.W	G.W	C.B.M	SIZE
	Packing 20	6.75kg	7.82kg	0.1131	715x280x565mm
<b>12.445</b>	<b>Height: 900mm</b>		<b>x20</b> 		

EASEL 1380	QTY	N.W	G.W	C.B.M	SIZE
	Packing 20	10kg	11.4kg	0.1441	715x280x720mm
<b>12.446</b>	<b>Height: 1380mm</b>		<b>x20</b> 		

## PODIUM DETAILS

\*mm

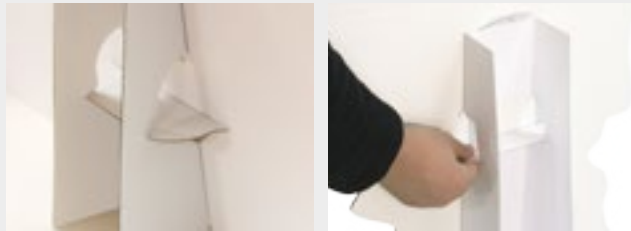

## INFORMATION

The double wing cardboard easel backs adds that extra support for slightly and wider signs. They are ideal for creating stand up displays with big dimensions.

## CARDBOARD EASELS

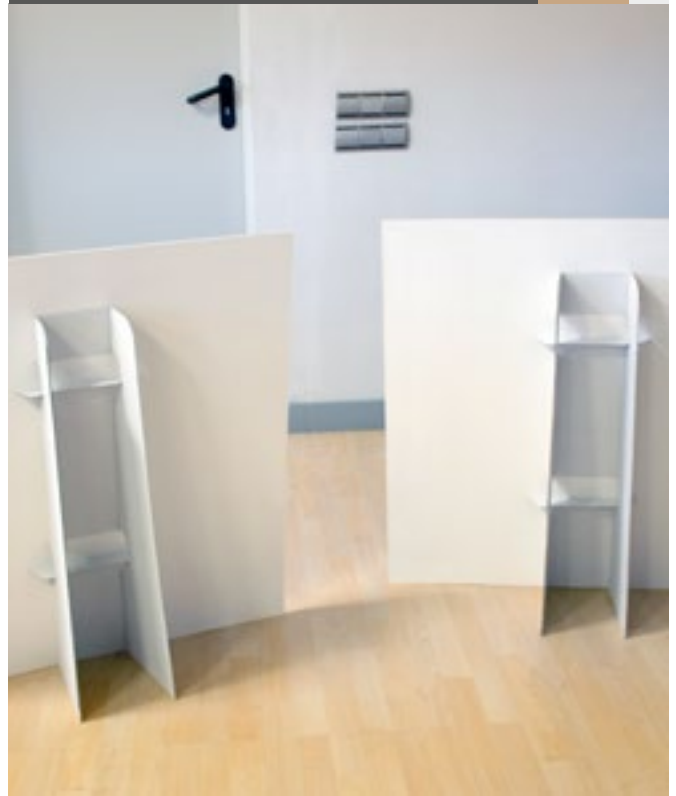

## SHEETS DETAILS

\*mm



## INFORMATION

- Pack of 10 units.
- Lightweight sheets.
- 2 sided white coated.
- A4 and A3 sizes available.
- 1.5mm thickness cardboard.
- White sheets offer a nice clean look, also provides added durability and a pleasant white look in the workplace or home, for displaying, modelling, arts or protecting packages, easy to store.

A4 SHEETS	QTY	N.W	G.W	C.B.M	SIZE
Packing	10	0.32kg	0.4kg	0.0013	220x20x305mm
<b>10.994</b>		<b>A4</b>			<b>x10</b> 
A3 SHEETS	QTY	N.W	G.W	C.B.M	SIZE
Packing	10	0.65kg	0.8kg	0.0026	430x20x305mm
<b>10.995</b>		<b>A3</b>			<b>x10</b> 

## SHEETS



FIXING SPEARS DETAILS



INFORMATION

\*mm

The fixing spears are made of lightweight plastic, using it with nylon wire (not included) they are an easy solution for hanging promotional offers from ceiling. Also thanks to its design they are ideal for being used with foamboards signages.

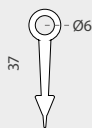

FIXING SPEARS	LENGTH	
12.538	37mm	x100 

FIXING SPEARS



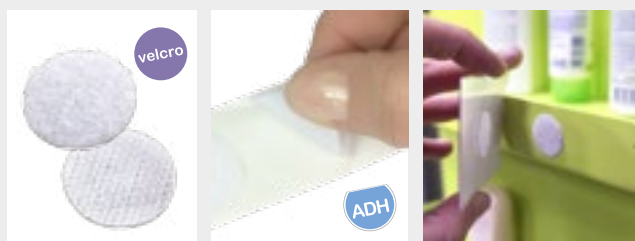

DISCS DETAILS



INFORMATION

These adhesive adjustable tape discs are easy to use and they are durable and strong. Allows an easily changing of signage position thanks to its male and female genuine VELCRO® brand sides. 3 diameters available. Ideal for being used with paper crafts, cardboard or displays.

TAPE DISCS	DIAMETER	
12.505	♂ 10mm	x1000 
12.506	♀ 10mm	
12.507	♂ 20mm	x1000 
12.508	♀ 20mm	
12.509	♂ 25mm	x1000 
12.510	♀ 25mm	

ADJUSTABLE TAPE DISCS



\* VELCRO® is a registered trademark of Velcro BVBA. | VELCRO® est une marque déposée de Velcro Industries B.V. | VELCRO® é uma marca registrada de Velcro Industries B. V. | VELCRO® es una marca registrada de VelcroIndustries B. V.



DISPLAY DETAILS



INFORMATION

\*mm

This open display features a portrait shape and 7 sizes for documents. Includes 2 adhesive strips at the back side for fixing on different surfaces. Paper slips in easily through the sides.

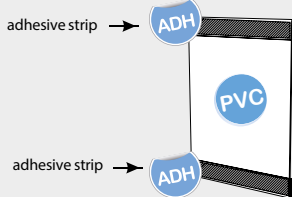

SANDWICH PORTRAIT THICKNESS

SANDWICH	PORTRAIT	THICKNESS			
13.428	A1	0.5mm	x10 		
13.429	A2	0.5mm	x10 		
13.064	A3	0.5mm	x10 		
13.065	A4	0.5mm	x10 		
13.066	A5	0.5mm	x20 		
13.067	A6	0.5mm	x20 		
13.430	A7	0.5mm	x30 		

ADHESIVE PVC POCKET



HANGER DETAILS

\*mm

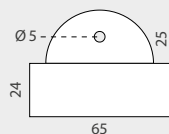

INFORMATION

Made of 0.04mm PVC and it has a front adhesive. Ideal for hanging foam board, cardboard, posters on walls, ceiling or hanging from prongs.

PVC HANGER

SIZE

12.512	65x49mm	x50 
--------	---------	---

ADHESIVE PVC HANGER



## CONNECTOR DETAILS

## INFORMATION

\*mm

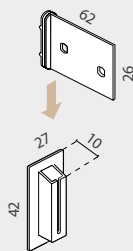

Two interlocking connector pieces for bonding into corrugated cardboard, which are designed for a solid and great supporting on shelf. Also allows an easy flat pack distribution. Ideal for the construction of cardboard displays.

C-27x42x62 PLATE SIZE BASE SIZE

12.517 62x26mm 27x42mm x100 

## CARDBOARD CONNECTOR

62x26mm PLATE



## CONNECTOR DETAILS

## INFORMATION

\*mm

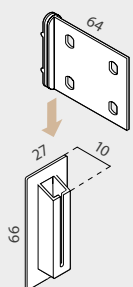

Two interlocking connector pieces for bonding into corrugated cardboard, which are designed and great supporting on shelf. Also allows an easy flat pack distribution.

C-27x66x64 PLATE SIZE BASE SIZE

12.516 64x43mm 27x66mm x100 

## CARDBOARD CONNECTOR

64x43mm PLATE



## CONNECTOR DETAILS

## INFORMATION

\*mm

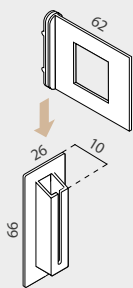

Two interlocking connector pieces for bonding into corrugated cardboard, which are designed and great supporting on shelf. Also allows an easy flat pack distribution.



C-26x66x62 PLATE SIZE BASE SIZE

12.515 62x47mm 26x66mm x100 

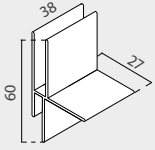

## CARDBOARD CONNECTOR

62x47mm PLATE



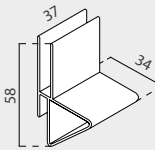

CLIP DETAIL	INFORMATION	DIMENSIONS	*mm
	Transparent PVC clip for quick and secure corrugated shelf construction by slotting into die cut holes.		
BRACKET	SIZE		
12.514	38x60x27mm	x100 	



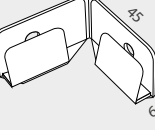

CLIP DETAIL	INFORMATION	DIMENSIONS	*mm
	Transparent and reinforced clip for quick and secure, high strength corrugated shelf construction by slotting into die cut holes.		
REINFORCED	SIZE		
12.513	37x58x34mm	x100 	



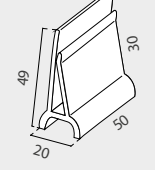

CASTER DETAIL	INFORMATION	DIMENSIONS	*mm
	Caster rises the cardboard display to avoid the contact with the ground and also enables easy moving of the cardboard display. Fast assembly with clip on bottom of cardboard display.		
SIMPLE	CORNER LENGTH		
12.286	45x45mm	x100 	



CASTER DETAIL	INFORMATION	DIMENSIONS	*mm
	This caster feet rises display from ground extending the life of usage. It enables easy moving of cardboard display. Easy assembly with clip on bottom of cardboard display.		
CLIP	HEIGHT		
12.518	49mm	x100 	

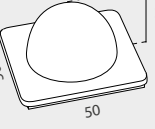

CASTER DETAIL	INFORMATION	DIMENSIONS	*mm
	This caster rises the cardboard display 23mm from the ground and protects it from damaging, featuring a 50x50mm adhesive foam. It also enables easy moving of display. Fast assembly.		
ADHESIVE	SIZE		
12.287	50x50x23mm	x100 	

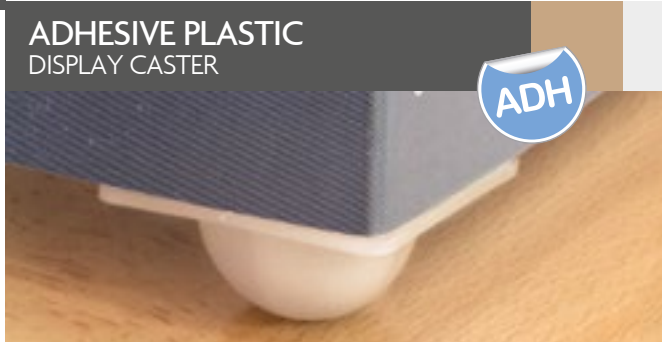

# CARDBOARD ACCESSORIES Rivets | Screws

## INFORMATION

We provide an excellent selection of fasteners, such as plastic bolts, nuts or screws for the signage attachment and other applications.

Plastic rivet fasteners have numerous applications and come in a wide variety of styles, sizes, and configurations to accommodate different panel dimensions.

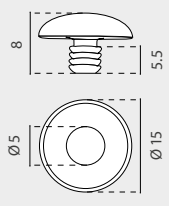
push



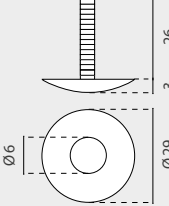

12.283    Ø 15 | Ø 5mm    5.5mm    x100 

push



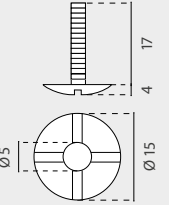

12.285    Ø 29 | Ø 6mm    26mm    x100 

screw



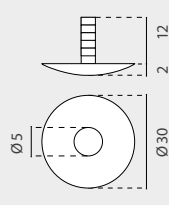

12.367    Ø 15 | Ø 5mm    17mm    x100 

push



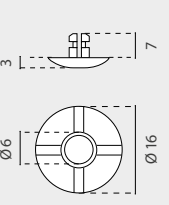

12.114    Ø 30 | Ø 5mm    12mm    x100 

push



12.469    Ø 16 | Ø 6mm    7mm    x100 

push

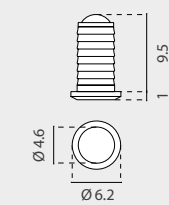

50.111    Ø 6.2 | Ø 4.6mm    9.5mm    x100 

# CARDBOARD ACCESSORIES Rivets | Screws





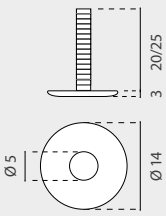

screw 

12.466	Ø 15   Ø 5mm	8mm	x100 
12.467	Ø 15   Ø 5mm	15mm	x100 
12.468	Ø 15   Ø 5mm	20mm	x100 



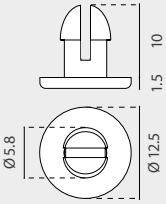

screw 

12.463	Ø 14   Ø 5mm	20mm	x100 
12.464	Ø 14   Ø 5mm	25mm	x100 



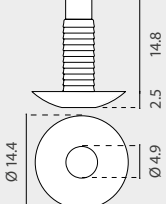

push 

12.521	Ø 12.5   Ø 5.8mm	10mm	x100 
--------	------------------	------	--



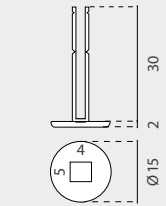

push 

50.110	Ø 14.4   Ø 4.9mm	14.8mm	x100 
--------	------------------	--------	--





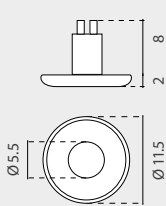

push 

12.532	Ø 15   6x5mm	30/12mm	x100 
--------	--------------	---------	--



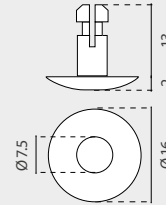

push 

12.533	Ø 11.5   Ø 5.5mm	10mm	x100 
--------	------------------	------	--



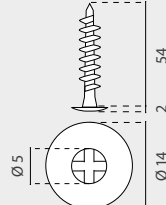

push 

12.534	Ø 16   Ø 7.5mm	15mm	x100 
--------	----------------	------	--



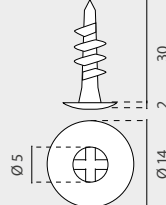

screw 

12.535	Ø 14   Ø 5mm	56mm	x100 
--------	--------------	------	--



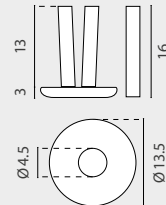

screw 

12.536	Ø 14   Ø 5mm	32mm	x100 
--------	--------------	------	--

push 

12.537	Ø 13.5   Ø 4.5mm	16mm	x100 
--------	------------------	------	--

## GRIPPER DETAIL INFORMATION \*mm



This "H" transparent PVC gripper takes up to 2mm thickness cards with 180° angle connection. Ideal for joining cardboard displays, mobiles construction or for displaying signage at POS.



H180 GRIPPER	SIZE		
12.197	19x7x25mm	x100	

## "H" 180° GRIPPER



## GRIPPER DETAIL INFORMATION \*mm



This "V" transparent PVC gripper takes up to 2mm thickness cards with 60° angle connection. Ideal for joining cardboard displays, mobiles construction or for displaying signage at POS.

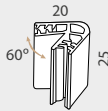

V60 GRIPPER	SIZE		
12.371	20x25mm	x100	

## "V" 60° GRIPPER

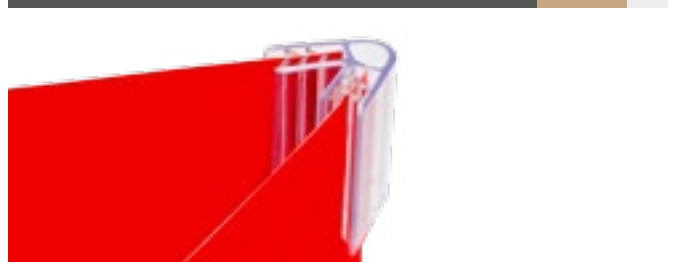

## GRIPPER DETAIL INFORMATION \*mm



This "L" transparent PVC gripper takes up to 2mm thickness cards with 90° angle connection. Ideal for joining cardboard displays, mobiles construction or for displaying signage at POS.

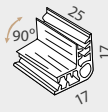

L90 GRIPPER	SIZE		
12.198	17x17x25mm	x100	

## "L" 90° GRIPPER



## GRIPPER DETAIL INFORMATION \*mm



This "Y" transparent PVC gripper takes up to 2mm thickness cards with a 3 ways connection. Ideal for joining cardboard displays, mobiles construction or for displaying signage at POS.

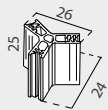

Y GRIPPER	SIZE		
12.372	26x24x25mm	x100	

## "Y" GRIPPER



## GRIPPER DETAIL INFORMATION \*mm





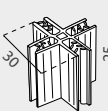



This "X" transparent PVC gripper takes up to 2mm thickness cards with a 4 ways connection. Ideal for joining cardboard displays, mobiles construction or for displaying signage at POS.

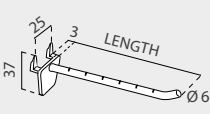

X GRIPPER	SIZE		
12.199	30x30x25mm	x100	





## "X" GRIPPER



PRONG DETAILS		INFORMATION		*mm
		Simple Plastic prong with 2 direct insert hook spikes wich lets you avoid the need for punching holes.		
SIMPLE PRONG	LENGTH			
12.261	51mm	x50		
12.262	76mm	x50		
12.263	102mm	x50		
12.264	127mm	x50		
12.265	152mm	x50		
12.266	210mm	x50		

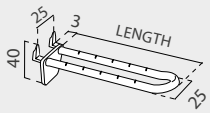





## SIMPLE QUICK-STICK PRONG

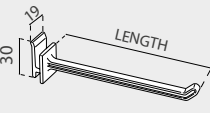

PRONG DETAILS		INFORMATION		*mm
		Double Plastic prong with 2 direct insert hook spikes wich lets you avoid the need for punching holes.		
DOUBLE PRONG	LENGTH			
12.258	105mm	x50		
12.259	152mm	x50		
12.260	210mm	x50		





## DOUBLE QUICK-STICK PRONG

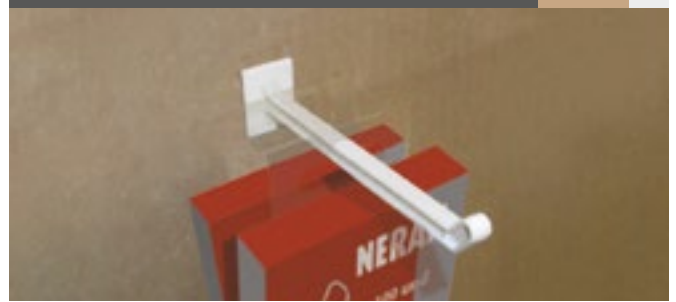

PRONG DETAILS		INFORMATION		*mm
		Plastic prong with plate for inserting in cardboard panels or displays. It requires a 19x10mm hole to fit.		
INSERT PRONG	LENGTH			
12.272	66mm	x50		
12.273	92mm	x50		
12.274	118mm	x50		
12.275	144mm	x50		
12.276	205mm	x50		

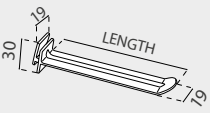

## INSERT PRONG



PRONG DETAILS		INFORMATION		*mm
		Plastic flat prong with plate for inserting in cardboard panels or displays. It requires a 19x10mm hole to fit.		
INSERT FLAT	LENGTH			
12.269	61mm	x50		
12.270	105mm	x50		
12.271	130mm	x50		

## INSERT FLAT PRONG

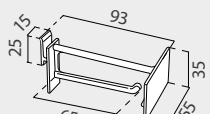

PRONG DETAILS		INFORMATION		*mm
		Plastic prong with holder and plate for inserting in cardboard panels. It requires a 19x10mm hole to fit in.		
INSERT PRONG	LENGTH			
12.112	65mm	x50		

## INSERT PRONG WITH HOLDER



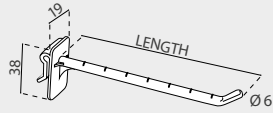

## PRONG DETAILS

## INFORMATION \*mm



This plastic prong can be attached to thickness from 2 to 4mm. Available in 2 different lengths. Needs hole of 19x10mm.

CLIP PRONG	LENGTH		
12.267	110mm	x50	
12.268	195mm	x50	

## CLIP PRONG



## PRONG DETAILS

## INFORMATION \*mm

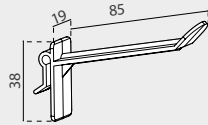

This plastic prong can be attached to thickness from 2 to 4mm. Available in 2 different lengths. Needs hole of 19x10mm.

CLIP FLAT PRONG	LENGTH		
12.330	85mm	x50	

## CLIP FLAT PRONG





## HOOK DETAILS

## INFORMATION \*mm

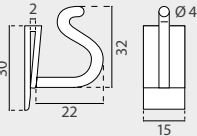

Clip-on over cardboard displays. "S" Hook is suitable to display small items, coupons, bags or samples. 15mm wide clip.



"S" HOOK	SIZE		
12.074	30x22x15mm	x100	

## "S" COUPON HOOK



## HOOK DETAILS

## INFORMATION \*mm



Clip-on over cardboard displays. "D" Hook is ideal for presenting coupons, gift cards or promotional products. 10mm wide clip.

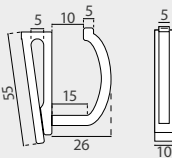

"D" HOOK	SIZE		
12.279	55x26x10mm	x100	

## "D" COUPON HOOK

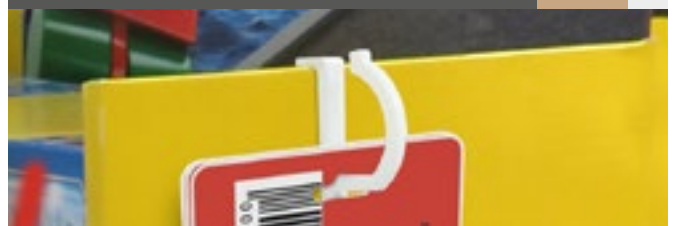



## HOOK DETAILS

## INFORMATION \*mm

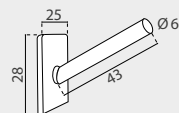

25x28mm adhesive pad with a 43mm length hook to attach directly to displays. No need for holes. For showing small items, like coupons or bags.



ADHESIVE HOOK	SIZE		
12.485	28x25x43mm	x100	 

## SMALL PLASTIC PRONG





# P.O.S. 12

Complete range of Grippers, Hangers, Price Holders, Hooks and Magnets which provide an integral solution for the exhibition at the Point Of Sale.

- 476** FRAME KIT
- 488** MINI FRAME KIT
- 490** PRICE HOLDERS
- 505** PRICE CARDS
- 506** HANGING SOLUTIONS
- 523** SUCTION CUPS
- 528** GRIPPERS
- 536** CARDBOARD SOLUTIONS
- 538** CARDBOARD ACCESSORIES
- 540** SHELF SIGNAGE





## FRAME COLOR DETAILS



## INFORMATION

This high quality Frames are available in 4 standard sizes and 8 different colors. The poster is inserted from the short side of the frame. All frames are suitable for being used in portrait or landscape setup. Thanks to its design and its multiple accessories to combine it, the Frame Kit is one of the most used systems for displaying prices or promotions in the supermarkets and in retail stores.





FRAME	SIZE	STANDARD	
12.053	105x148mm	A6	x10 
12.054	148x210mm	A5	x10 
12.055	210x297mm	A4	x10 
12.056	297x420mm	A3	x10 

## FRAMES



## PROTECTOR DETAILS



PROTECTOR	SIZE	THICKNESS	
12.057	A6	0.3mm	x10 
12.058	A5	0.3mm	x10 
12.059	A4	0.3mm	x10 
12.060	A3	0.3mm	x10 

## POSTER PROTECTOR



## INFORMATION

This sleeves protectors are made in 0.3mm "anti-reflective" and transparent glasspack. It is ideal for protecting your promotions from exposure or deterioration.

"T" CLIP DETAILS



INFORMATION

\*mm

"T" Clip is designed for being combined with Ø10mm telescopic poles, also is suitable for using with any Frame of Frame Kit Series. This "T" Clip is available in 4 different colors: transparent, red, black and grey.



"T" CLIP COLOR

12.077



x20 

"T" CLIP



FRAME JOIN CLIP DETAILS

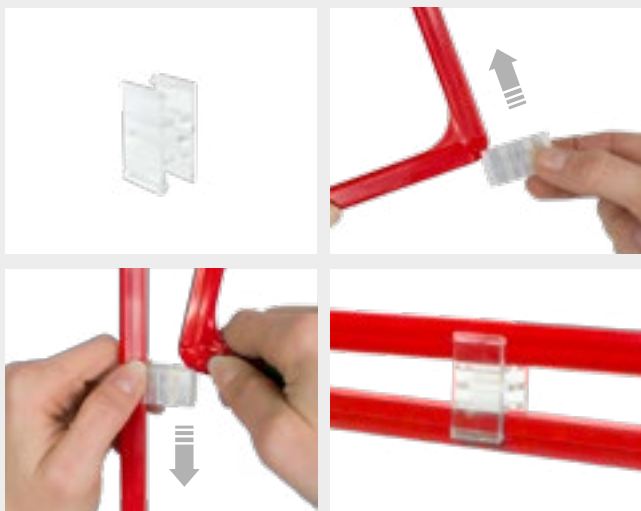

INFORMATION

\*mm

The Frame Join Clip is made of transparent plastic and it is suitable for being used with all our Frame Kit Series and also, for being used with portrait and landscape orientation. It is ideal for joining together frames and create associated promotions chained by 2 or more Frames Kits.

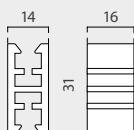

FRAME JOIN

12.087

x20 

FRAME JOIN CLIP



**BIG CLIP DETAILS**



**INFORMATION**

The Big Clip is made of transparent plastic. Suitable for being used with Frame Kit Series. It is ideal for wire baskets, tubes or shelves.

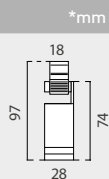

\*mm

BIG CLIP                      MAX. SIZE

50.813                      28x97x27mm                      x20 

**BIG CLIP FOR FRAME KIT**



**CLAMP DETAILS**

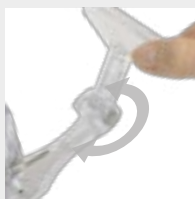

**INFORMATION**

This big Clamp + "T" Clip are made of transparent plastic. Suitable for being used with all Frame Kit series. Ideal for tubes, dumpbins or shelves.

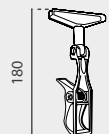

\*mm

CLAMP                      HEIGHT

12.291                      180mm                      x20 

**CLAMP FOR FRAME KIT**



**UNICLIPPER DETAILS**



**INFORMATION**

This Unclipper is made of opaque plastic and it includes a "T" Clip. Suitable for being used with all Frame Kit series. Ideal for tubes, dumpbins or for shelves.



\*mm

UNICLIPPER

50.860                      x20 

**UNICLIPPER FOR FRAME KIT**



## BASKET CLIP DETAILS



### INFORMATION

The Basket Clip is made of transparent plastic. It is suitable for being used with all Frame Kit Series. Also it is ideal for connecting frames with the wire dumpbins or any Ø10mm tubes.

\*mm

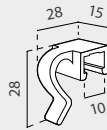

### BASKET CLIP

12.084 x20 

## BASKET CLIP





## TUBE CLIP DETAILS

### INFO



\*mm



- REF 12.083  Ø26
- REF 12.082  Ø22
- REF 12.081  Ø18

Transparent ring with frame clip connector. 3 diameters available.

### TUBE CLIP

TUBE CLIP	DIAMETER	
12.081	Ø18mm	x20 
12.082	Ø22mm	x20 
12.083	Ø26mm	x20 

## TUBE CLIP



## RING "T" CLIP DETAILS

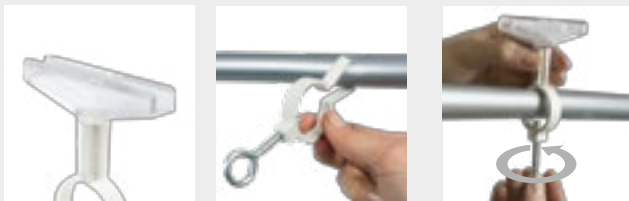

### INFORMATION

\*mm

Transparent "T" Clip + Adjustable white Ring. Suitable for being used with Frame Kit. It is suitable for being used with all Frame Kit Series. Ideal for poles, tubes, baskets or grating.

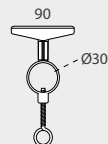

### RING "T"

DIAMETER  
12.292 Ø30mm x20 

## RING "T" CLIP



RING CLIP DETAILS

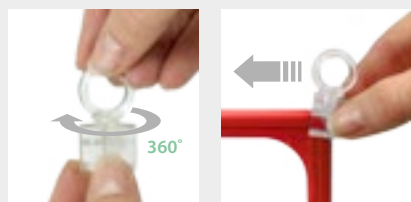

INFORMATION

\*mm

This Clip is made of transparent plastic and it features a 360° rotatory ring. It is suitable for being used with all Frame Kit Series. Ideal for holding frames.



RING CLIP

12.090

x20 



RING CLIP FOR FRAME KIT



10 HOOK CLIP DETAILS



INFORMATION

\*mm

This Hook Clip is made of transparent plastic. It is suitable for being used with all Frame Kit Series. It is ideal for hanging promotions at the supermarkets.

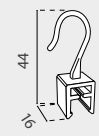

HOOK CLIP 10

DIAMETER

12.091

Ø10mm

x20 

HOOK CLIP 10mm



20 HOOK CLIP DETAILS



INFORMATION

\*mm

This big Hook Clip is made of transparent plastic. It is suitable for being used with all Frame Kit Series. It is ideal for hanging promotions at the supermarkets.

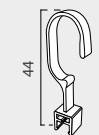

HOOK CLIP 20

DIAMETER

12.092

Ø20mm

x20 

HOOK CLIP 20mm



FRAME SIDE HOOK DETAILS

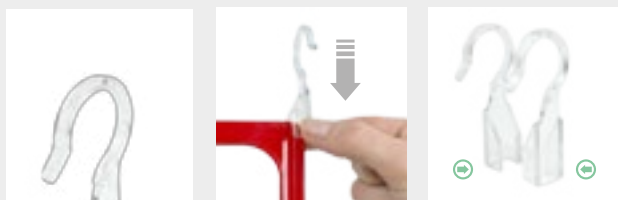

**INFORMATION** \*mm

This Frame Side Hook is made of transparent plastic. It features two designs (left and right) for being used on both sides of any Frame Kit Series. Ideal for wire baskets or dumpbins.



SIDE CLIP	DIAMETER		
12.094	Ø20mm	 x10 Uni	 x10 Uni

FRAME SIDE HOOK





RAIL CLIP DETAILS

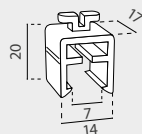

**INFORMATION** \*mm

The Rail Clip is made of transparent plastic. It is suitable for being used with all Frame Kit Series. Also it is ideal for connecting frames to ceiling-rails and get an easily mobile Frame Kit system over all the products in promotion.



RAIL CLIP	
12.089	x20 

RAIL CLIP





WALL CLIP DETAILS

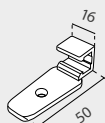

**INFORMATION** \*mm

The Wall Clip is made of transparent plastic. It is suitable for being used with all Frame Kit Series. It is ideal for connecting frames with walls, inclined surfaces or in any other place where leaving the Frame Kit fixed was needed.



WALL CLIP	
12.080	x20 

WALL CLIP



FRAME BASE CLIP DETAILS



INFORMATION

\*mm

This Base Clip is made of transparent plastic. Its slightly inclined design is ideal for displaying promotions and offers by using any Frames Kit Series.

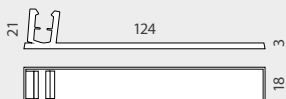

BASE CLIP

12.093

x10 

FRAME BASE CLIP



GRIPPER CLIP DETAILS



INFORMATION

\*mm

The Gripper Clip is made of transparent plastic and it is suitable for being used with all Frame Kit Series. Also it is perfect for attaching last-minute promotions to a Frame Kit. It holds cards up to 1mm thick.

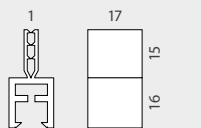

GRIPPER CLIP

12.088

x20 

GRIPPER CLIP



FRAME KIT GRIPPER DETAILS



INFORMATION

\*mm

This Gripper is made of transparent plastic. It is suitable for being used with all Frame Kit Series. Ideal for cards or promotional labels up to 3mm thickness.

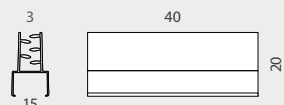

FRAME GRIP

12.524

x100 

FRAME KIT GRIPPER





## SUPPORT DETAIL

## INFORMATION

\*mm



This support is made of grey plastic. It is suitable for being used with all Frame Kit Series. It is ideal as magnetic base or holder for frames on gondolas or metallic shelves.

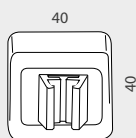

FRAME MAG.

12.096

x20 

## FRAME CLIP MAGNETIC SUPPORT



## SUPPORT DETAIL

## INFORMATION

\*mm



This support is made of grey plastic. It is suitable for being used as intermediate support for telescopic tubes. It is ideal as holder for telescopic tubes on gondolas or metallic shelves.

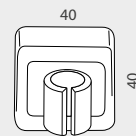

MID MAG.

12.097

x20 

## MIDDLE TUBE MAGNETIC SUPPORT



## SUPPORT DETAIL

## INFORMATION

\*mm



This support is made of grey plastic. It is suitable for being used as end support for telescopic tubes. It is ideal for holding telescopic tubes on gondolas or metallic shelves.

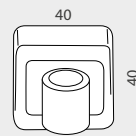

END TUBE

12.098

x20 

## END TUBE MAGNETIC SUPPORT



## SUPPORT DETAIL

## INFORMATION

\*mm



This support is made of grey plastic. It is suitable for being used as holder for all Frame Kit series. It is ideal as magnetic base or holder for frames on gondolas or metallic shelves.

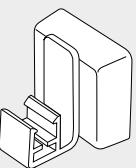

HOOK MAG.

12.099

x20 

## FRAME HOOK MAGNETIC SUPPORT



## MAGNETIC CLIP

## INFORMATION

\*mm



This T Clip is made of grey plastic. It is suitable for being used as holder for all Frame Kit series. It is ideal as magnetic base or holder for frames on gondolas or metallic shelves.

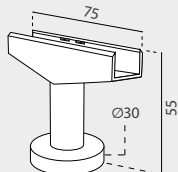

'T' CLIP

12.079

x20 

## 'T' CLIP MAGNETIC SUPPORT



## PLASTIC BASE STAND DETAILS





\*mm



REF  
12.240

## INFORMATION

"T" Clamp + Telescopic Tube + Plastic Base. Ideal for placing underneath pallets.

PLASTIC	SIZE *mm		
12.239	Pole: 150+150	x10	
12.240	Pole: 150+150	x10	
12.062	Pole: 300+300	x10	
12.063	Pole: 300+300	x10	
12.065	Pole: 500+500	x10	
12.066	Pole: 500+500	x10	
12.242	Pole: 750+750	x10	
12.243	Pole: 750+750	x10	

## EXTENDABLE FLOOR PLASTIC STAND



## METALLIC BASE STAND DETAILS



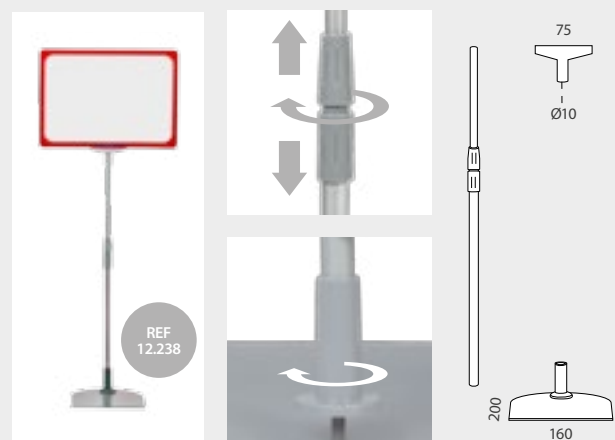

\*mm



REF  
12.238

## INFORMATION

"T" Clamp + Telescopic Tube + Metallic Base. Ideal for placing underneath pallets.

METALLIC	SIZE *mm		
12.238	Pole: 150+150	x10	
12.061	Pole: 300+300	x10	
12.064	Pole: 500+500	x10	
12.241	Pole: 750+750	x10	

## EXTENDABLE FLOOR METALLIC STAND



\* the frames at this page are available but not included

STAND DETAILS

INFORMATION

\*mm



This Stand includes 1 telescopic pole (1900mm max. height) + Ø240mm rounded metal base + "T" Clamp. Ideal for placing close to the product.

EXT. STAND

STAND POLE

12.068

950+950mm

x10 

EXTENDABLE CLAMP STAND



STAND DETAILS

INFORMATION

\*mm

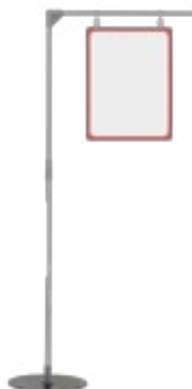

It includes 1 telescopic pole (1900mm max. height) + Ø240mm rounded metal base + 1 Upper arm + 2 hooks. Ideal for placing close to the product.

EXT. STAND

STAND POLE

UPPER ARM

12.405

950+950mm

507mm

x10 

EXTENDABLE 1 ARM STAND



STAND DETAILS

INFORMATION

\*mm

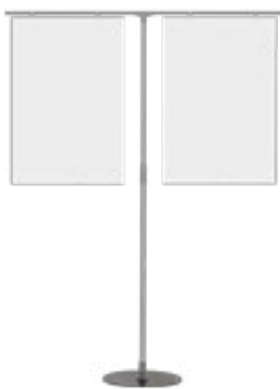

It includes 1 telescopic pole (1900mm max. height) + Ø240mm metal base + "T" Clamp + 1 Upper arm + 4 hooks. Ideal for placing close to the product.

EXT. STAND

STAND POLE

UPPER ARM

12.406

950+950mm

1010mm

x10 

EXTENDABLE 2 ARM STAND



\* the frames at this page are available but not included

CLAMP SUPPORT DETAILS

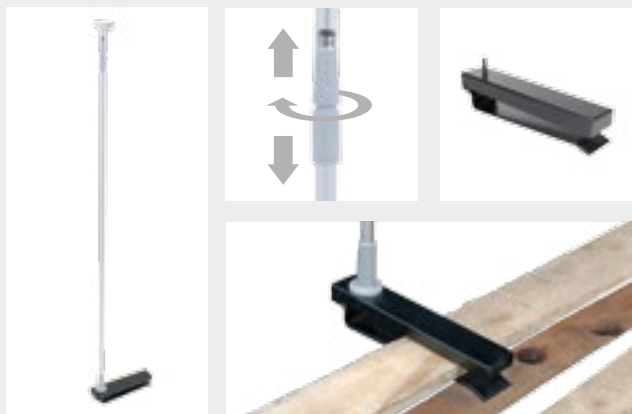

INFORMATION

\*mm

This clamp is suitable for pole stands and it is ideal for displaying promotional posters or pricing banners beside the pallets of supermarkets or stores.

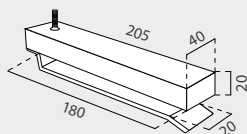

PALLET CLAMP      LENGTH

12.400	205mm	x10 
--------	-------	---

CLAMP SUPPORT FOR PALLET



EXTENDABLE STAND DETAILS

\*mm



INFORMATION

This extendable support features a "T" Clip + Telescopic Tube + Spring so it is suitable for being used with all Frame Kit Series. Thanks to its adjustable spring Extendable Stand is ideal for being used on wire dumpbins, wire baskets or pegboards at supermarkets or stores. Once incorporated into the wire dumpbin or the pegboard, you can adjust the height of the displaying thanks to its telescopic pole. It is perfect for displaying promotions, temporary sales or for price graphics.

SPRING STAND      HEIGHT

12.069	310-532mm	x10 
--------	-----------	---

EXTENDABLE STAND WITH SPRING



\* the frames at this page are available but not included

MINIBOARD DETAILS



INFORMATION

\*mm

This Mini Board for Ø10mm telescopic tubes is made in grey ABS. For using with a frame kit. To place the Mini Board at half height of the pole just break the top flap. Thanks to its attachable design, it is ideal to use with 1 or 2 facing boards and create a double-sided display for your tube display.

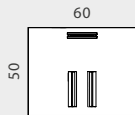

MINI BOARD

SIZE

12.554

50x60mm

x20 

MINI BOARD  
FOR Ø10mm TELESCOPIC TUBE



SUPPORT DETAILS

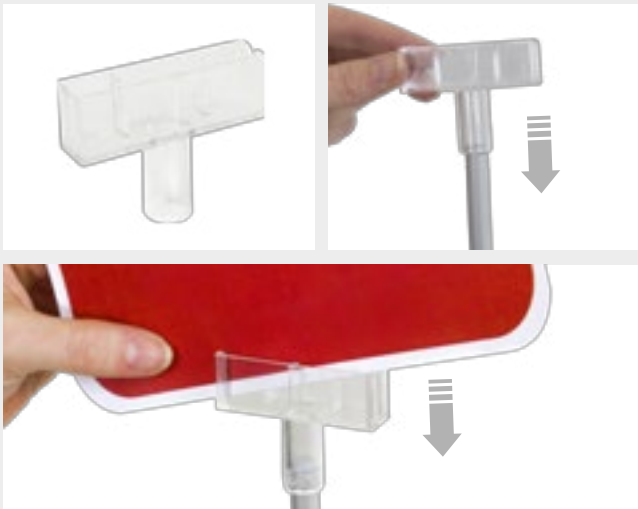

INFORMATION

\*mm

This transparent graphic support is made of plastic and it is suitable for combining with telescopic tubes. It holds a  $\pm 1.5$ mm maximum thickness cards. It is perfect for displaying promotions at the supermarkets.

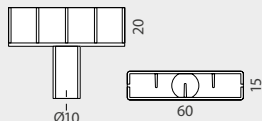

SUPPORT

12.338

x25 

GRAPHIC SUPPORT



## FRAME DETAILS

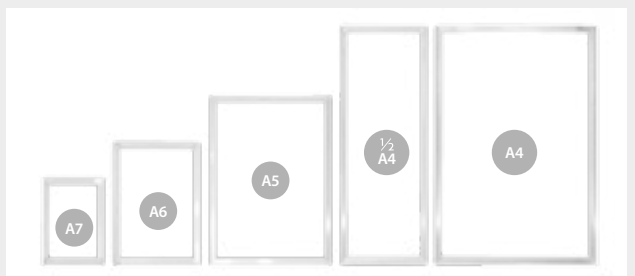
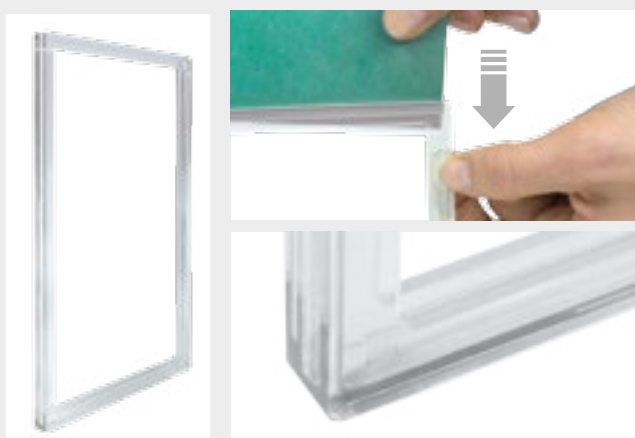

## INFORMATION

This high quality and extrafine transparent frames Mini Frames are available in 5 sizes. The poster is inserted from the short side. Also it features its exclusive full range of accessories. Thanks to its design and its multiple accessories to combine it, the Mini Frame Kit is ideal for displaying prices or promotions in the supermarkets and retail stores.





FRAMES	SIZE	GRAPHIC SIZE		
12.336	 74x105mm	A7	x10	
12.322	 105x148mm	A6	x10	
12.323	 148x210mm	A5	x10	
12.324	 105x297mm	1/2 A4	x10	
12.325	 210x297	A4	x10	

## TRANSPARENT MINI FRAMES



## PROTECTOR DETAILS



PROTECTOR	SIZE	THICKNESS		
12.337	A7	0.3mm	x10	
12.057	A6	0.3mm	x10	
12.058	A5	0.3mm	x10	
12.328	1/2 A4	0.3mm	x10	
12.059	A4	0.3mm	x10	

## POSTER PROTECTOR

0.3mm thick

Anti Reflex

3 sides open



## INFORMATION

This sleeves protectors are made in 0.3mm "anti-reflective" and transparent glasspack. It is ideal for protecting your promotions from exposure or deterioration.

## CARD CLIP DETAIL

## INFORMATION

\*mm



This Clip is made of transparent plastic and it is perfect for attaching last-minute cards promotions to a Mini Frame. It holds cards up to Xmm thick.

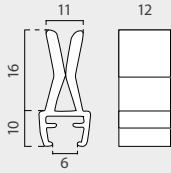

MINI CARD CLIP

12.332

x20 

## MINI CARD CLIP



## BASE CLIP DETAIL

## INFORMATION

\*mm



This Base Clip is made of transparent plastic. Its slightly inclined design is ideal for displaying by using any Frames Kit Series

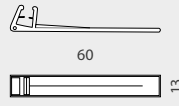

MINI BASE CLIP

12.333

x20 

## MINI BASE CLIP



## CARD CLIP DETAIL

## INFORMATION

\*mm



This Join Clip is made of transparent plastic. It is ideal for joining together frames and for creating associated promotions chained by various Mini Frames Kit.

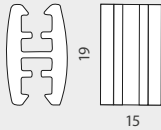

MINI JOIN CLIP

12.334

x20 

## MINI JOIN CLIP

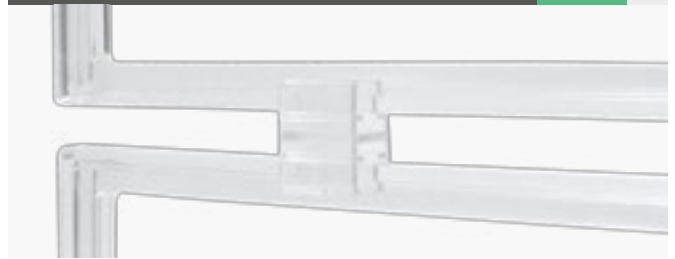

## CARD CLIP DETAIL

## INFORMATION

\*mm



This Frame Side Hook is made of transparent plastic. It features two designs (left and right) for being used on both sides of any Mini Frame Kit Series.

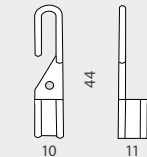

MINI SIDE HOOK

12.095

x20 

 10 uni

 10 uni

## MINI SIDE HOOK



## CARD CLIP DETAIL

## INFORMATION

\*mm



This Hook Clip is made of transparent plastic. Suitable for being used with all Frame Kit Series. It is ideal for hanging the promotions at retail stores or supermarkets.

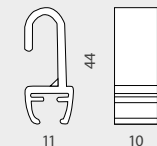

MINI HANGING

12.335

x20 

## MINI HANGING HOOK



CLAMP DETAILS





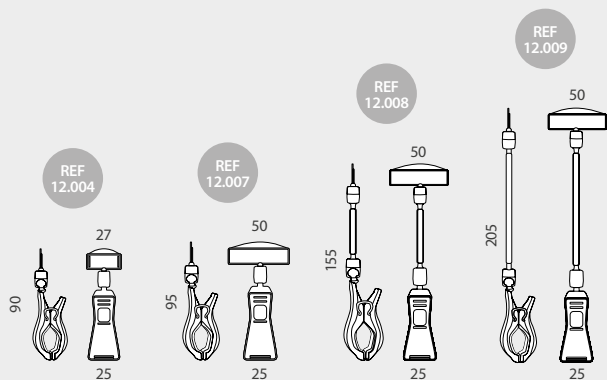

DIMENSIONS

\*mm



INFORMATION

This transparent Clamp holder provides a whole angle view thanks to its movable ball joint (2 ball-joints for 12.009 and 12.008 models). With a 25mm wide lower clamp and an upper card holder wich allows the insertion of cards up to 1mm thickness. . It is ideal for displaying close to the product and it is widely used in price tags and goods exhibitions in the shopping mall which can make thing more obvious and catch customers attentions.

C. 205	COMBINATION	LENGTH	BALL-JOINT		
12.009	Clamp + Holder	205mm	2	x25	
12.008	Clamp + Holder	155mm	2	x25	
12.007	Clamp + Holder	95mm	1	x25	
12.004	Clamp + Holder	90mm	1	x25	

HOLDER WITH CLAMP  
PRICE HOLDERS





CLAMP DETAILS

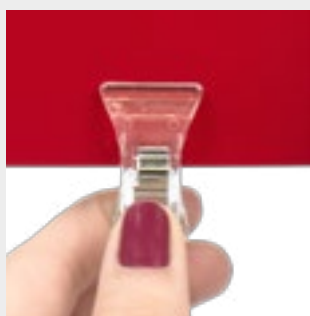



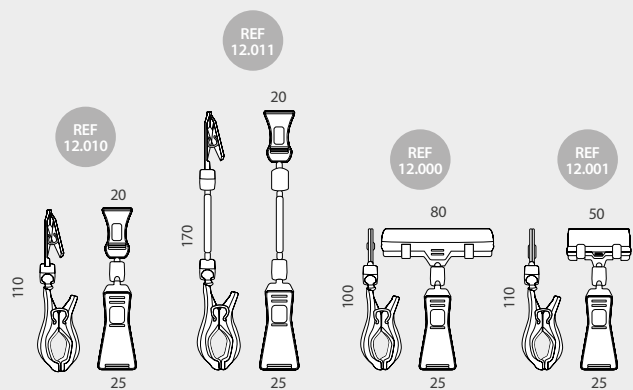

DIMENSIONS

\*mm



INFORMATION

This transparent Clamp holder provides a whole angle view thanks to its movable ball joint (2 ball-joints for 12.011 model). With a 25mm wide lower clamp and a 20mm upper clip (80mm upper clamp for 12.000 model and 50mm upper clamp for 12.001 model). It is ideal for displaying close to the product and it is widely used in price tags and goods exhibitions in the shopping mall which can make thing more obvious and catch customers attentions.

C. 205	COMBINATION	LENGTH	BALL-JOINT			
12.010	Clamp + Clip	110mm	1	x25		
12.011	Clamp + Clip	170mm	2	x25		
12.000	Clamp + Clamp	100mm	1	x25		
12.001	Clamp + Clamp	110mm	1	x25		

CLIP WITH CLAMP  
PRICE HOLDERS



CLIP DETAILS

DIMENSIONS

\*mm

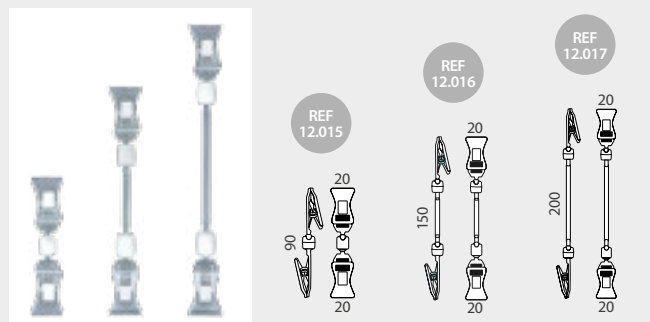

INFORMATION

This transparent holder provides a whole angle view thanks to its double movable ball joint. With a 20mm wide lower clip and a 20mm upper clip. Length from 90 to 200mm. It is ideal for displaying close to the product.

CLIP	COMBINATION	LENGTH	BALL-JOINT	
12.015	Clip + Clip	90mm	1	x25 
12.016	Clip + Clip	150mm	2	x25 
12.017	Clip + Clip	200mm	2	x25 

DOUBLE CLIP  
PRICE HOLDERS



CLIP DETAILS



DIMENSIONS

\*mm

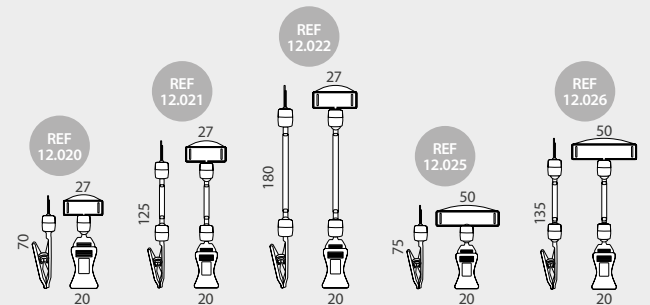

INFORMATION

This transparent holder provides a whole angle view thanks to its double movable ball joint. With a 20mm wide lower clip and 20mm or 50mm upper clip. Length from 70 to 180mm. It is ideal for displaying close to the product.

CLIP	COMBINATION	LENGTH	BALL-JOINT	
12.020	Clip + Holder	70mm	1	x25 
12.021	Clip + Holder	125mm	2	x25 
12.022	Clip + Holder	180mm	2	x25 
12.025	Clip + Holder	75mm	1	x25 
12.026	Clip + Holder	135mm	2	x25 

CLIP WITH HOLDER  
PRICE HOLDERS



CLIP DETAILS



DIMENSIONS

\*mm

INFORMATION

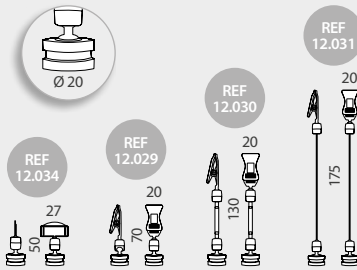

This transparent holder provides a whole angle view thanks to its double movable ball joint. With a Ø20mm lower magnetic base and a 20mm upper clip or 27mm upper (1mm thick) holder. It is ideal for placing prices or promotions near to the product at supermarkets.

MAGNETIC	COMBINATION	LENGTH	BALL-JOINT	
12.034	Magnet + Holder	50mm	1	x25 
12.029	Magnet + Clip	70mm	1	x25 
12.030	Magnet + Clip	130mm	2	x25 
12.031	Magnet + Clip	175mm	2	x25 

MAGNETIC PRICE HOLDERS



CLIP DETAILS

DIMENSIONS

\*mm

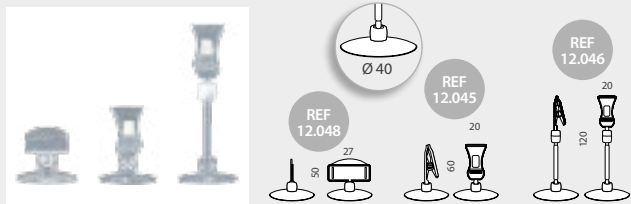

INFORMATION

\*mm

This price holder provides a whole angle view thanks to its movable ball joint. With a Ø40mm lower suction cup and upper 27mm card holder or 20mm clip.

SUCTION	COMBINATION	LENGTH	BALL-JOINT	
12.048	Suction + Holder	50mm	1	x25 
12.045	Suction + Clip	60mm	1	x25 
12.046	Suction + Clip	120mm	2	x25 

SUCTION PRICE HOLDERS



HOLDER DETAILS

INFORMATION

\*mm

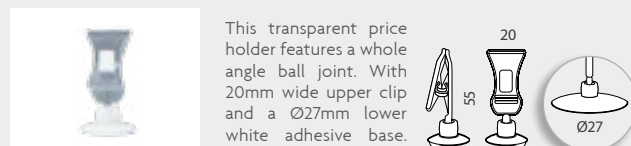

This transparent price holder features a whole angle ball joint. With 20mm wide upper clip and a Ø27mm lower white adhesive base.

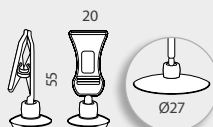

ADHESIVE CLIP	LENGTH	
12.042	55mm	x25 

ADHESIVE PRICE HOLDER



# PRICE HOLDERS Base Holders

## BASE DETAILS

## DIMENSIONS

\*mm



## INFORMATION

50 or 160mm length price holder with whole angle ball joint. With a Ø55mm lower base and a 20mm upper clip. It is ideal for displaying close to the product.

BASE	COMBINATION	LENGTH	BALL-JOINT		
12.039	 Base + Clip	50mm	1	x25	
12.040	 Base + Clip	160mm	2	x25	

## Ø55mm BASE PRICE HOLDERS



## CLIP DETAILS





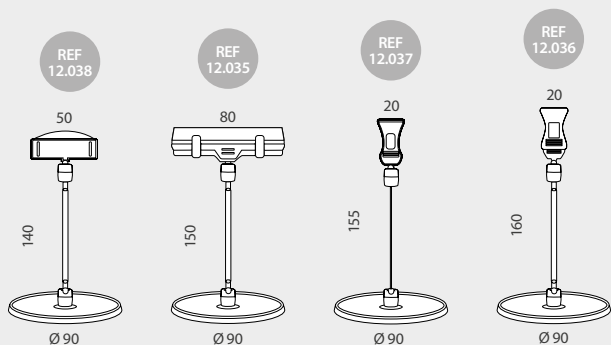

## DIMENSIONS

\*mm



## INFORMATION

With double movable ball joint this Ø90mm base (transparent or yellow) is ideal for placing prices near to the product without the need of holding the price-holder. Perfect for displaying bakery, fruit or shelving promotions.

BASE	COMBINATION	LENGTH	BALL-JOINT		
12.038	 Base + Holder	140mm	2	x25	
12.035	 Base + Clamp	150mm	2	x25	
12.037	 Base + Clip	155mm	2	x25	
12.036	 Base + Clip	160mm	2	x25	

## Ø90mm BASE PRICE HOLDERS



PRICE HOLDER DETAILS

INFORMATION \*mm

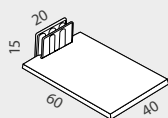

Ideal for informative notes, menus or prices closer to the promotion. It features a straight clip price holder, made of transparent plastic.

STRAIGHT BASE

SIZE

12.208

40x60mm

x100 

STRAIGHT BASE PRICE HOLDER



PRICE HOLDER DETAILS

INFORMATION \*mm

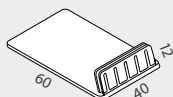

Ideal for informative notes, menus or prices closer to the promotion. It features an angular clip price holder made of transparent plastic.

ANGULAR BASE

SIZE

12.459

40x60mm

x100 

ANGULAR BASE PRICE HOLDER



PRICE HOLDER DETAILS

INFORMATION \*mm

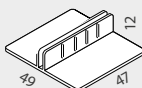

This squared clip base for price holders is made of transparent plastic and it is ideal for informative notes, cards or menu prices.

SQUARE BASE

SIZE

12.460

49x47mm

x100 

SQUARE BASE PRICE HOLDER



PRICE HOLDER DETAILS

INFORMATION \*mm

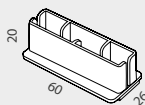

This transparent holder provides a sturdy adhesive fastening. Its 60mm width clip is ideal for displaying cards near to the product.

SIGN

SIZE

12.339

60x20mm

x25 

SIGN PRICE HOLDER

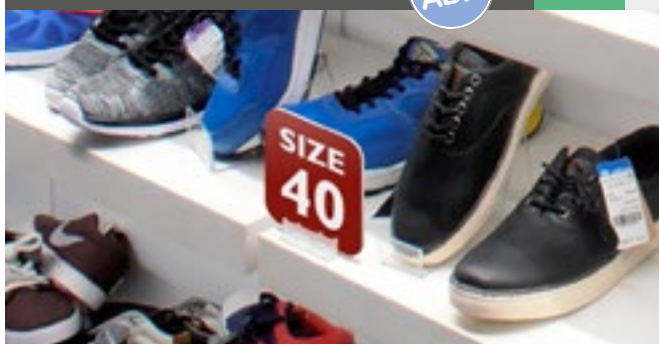

PRICE HOLDER DETAILS



INFORMATION

This stylish cube base holder features a XXmm clip ideal for displaying cards near to the product. Silver or black color available. Perfect for being used at supermarkets, restaurants, offices, hotels or retail stores.

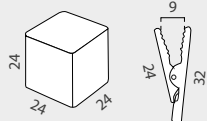

DIMENSIONS

\*mm



CROCOUBE

SIZE

17.038		24x24x170mm	x5 
17.039		24x24x170mm	x5 

CROCO CUBES



PRICE HOLDER DETAILS



INFORMATION

This hinged price holder provides an adjustable angle view thanks to its hinged steel holder. With an upper clip for holding sign and a sturdy Ø95mm flat steel base. This stylish price holder is ideal for placing informative notes or special offers near the products, food, bakery, fruits or for shelving promotions at the supermarkets.

DIMENSIONS

\*mm

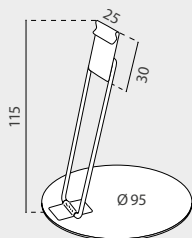

HINGED HOLDER

SIZE

12.519	Ø95x115mm	x10 
--------	-----------	---

HINGED PRICE HOLDER



HOLDER DETAILS



DIMENSIONS

\*mm

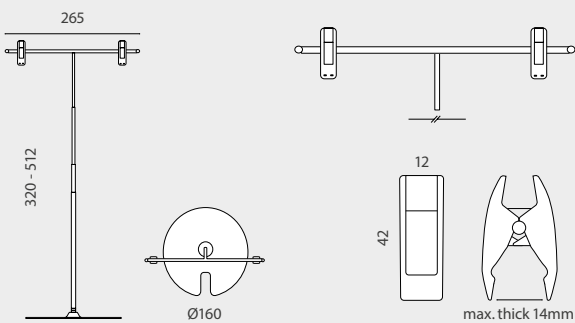

INFORMATION

These telescopic sign holders provide a high angle view thanks to its telescopic steel tube. With 2 upper clips made of transparent plastic for holding promotions and a sturdy flat base for placing under the products. The telescopic pole allows the possibility of placing the signs closer to the product. The change of promotion is really simple and fast and takes only few seconds. They are ideal for placing "banner" promotions, special offers or prices over the food or products at the supermarkets.

CLIP 260

12.052

Max.height:512mm

x10 

ADJUSTABLE SIGN HOLDER  
WITH ROUNDED BASE



HOLDER DETAILS



DIMENSIONS

\*mm

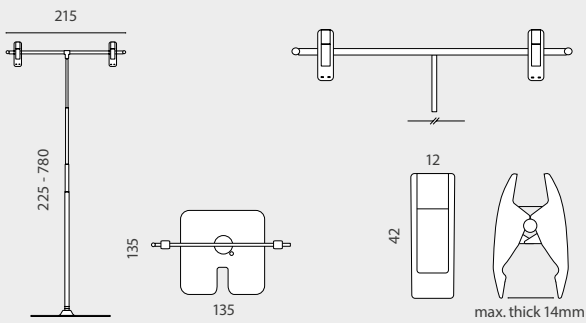

INFORMATION

These telescopic sign holders provide a high angle view thanks to its telescopic steel tube. With 2 upper clips made of transparent plastic for holding promotions and a sturdy flat base for placing under the products. The telescopic pole allows the possibility of placing the signs closer to the product. The change of promotion is really simple and fast and takes only few seconds. They are ideal for placing "banner" promotions, special offers or prices over the food or products at the supermarkets.

CLIP 210

12.050

Max.height: 800mm

x10 

ADJUSTABLE SIGN HOLDER WITH SQUARED BASE





HOLDER DETAILS



DIMENSIONS

\*mm

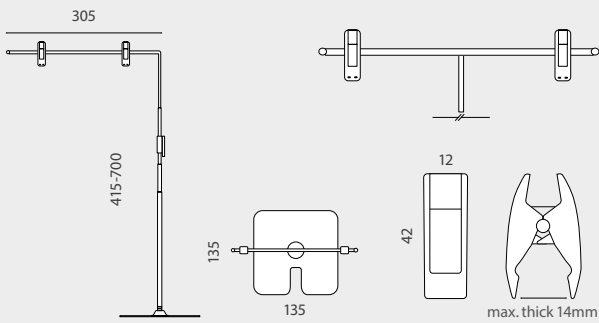

INFORMATION

These telescopic sign holders provide a high angle view thanks to its telescopic steel tube. With 2 upper clips made of transparent plastic for holding promotions and a sturdy flat base for placing under the products. The telescopic pole allows the possibility of placing the signs closer to the product. The change of promotion is really simple and fast and takes only few seconds. They are ideal for placing "banner" promotions, special offers or prices over the food or products at the supermarkets.

CLIP 310

12.051

Max.height: 700mm

x10 

ADJUSTABLE SIGN HOLDER  
1 ARM WITH SQUARED BASE



## LABEL SYSTEM

The label system provides different bases, price card connections or adapter for shelving.

Thanks to its multiple combinations, this Label System is ideal for pricing and food use.



### LABEL SYSTEM COMBINATIONS



## CARD CLIP

### INFORMATION

It is suitable for 50.820, 50.821, 50.822, 50.826 and 50.827 label system accessories.



CARD CLIP	SIZE	
50.823	18x21x9mm	x50 

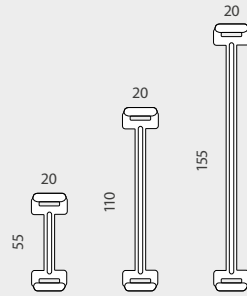

## ROD HOLDER

### DIMENSIONS



### INFORMATION

This rod holder is suitable for being used with 50.810, 50.823, 50.824 and 50.829 label system accessories. There are 3 lengths available for pricing near the products.

ROD HOLDER	LENGTH	
50.820	155mm	x50 
50.821	110mm	x50 
50.822	55mm	x50 

## ROD HOLDER CONNECTOR

### INFORMATION

Suitable for 50.810, 50.853, 50.854 and 50.855 label system accessories.



CONNECTOR	SIZE	
50.824	19x11x12mm	x50 

## LABEL BASE

### INFORMATION

Suitable for 50.824 label system accessory.



LABEL BASE	SIZE	
50.810	120x80x3mm	x50 

## LABEL SYSTEM



### LABEL SYSTEM COMBINATIONS



## EXTENSION STICK CONNECTOR



### INFORMATION

Connector suitable for Extension Stick (Ref. 50.801, 50.802, and 50.803) and Card Clip (Ref. 50.823).

### STICK CONN.

13.878

## EXTENSION STICK

### DIMENSIONS

\*mm

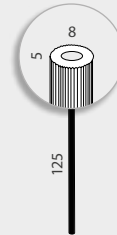

125



150

200



### INFORMATION

This extension stick is suitable for being used with Multi Support Base (Ref.50.800). There are 3 lengths available for pricing near the products.

STICK	LENGTH		
50.801	125mm	x50	
50.802	150mm	x50	
50.803	200mm	x50	

## CONNECTOR MULTI BASE - ROD



### INFORMATION

Suitable for 50.800, 50.820, 50.821 and 50.822 label system accessories.



\*mm

CONNECTOR	SIZE		
50.829	24x10x9mm	x50	

## MULTI SUPPORT BASE

### DIMENSIONS

\*mm

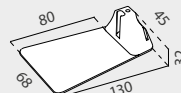

### INFORMATION

This bases is suitable for 50.801, 50.802, 50.803 and 50.829 label system accessories. It also features a front card slot

MULTI BASE	SIZE		
50.800	130x68x32mm	x50	

### CASSETTE PRICE HOLDER



**INFORMATION**

\*mm

With 2 opening 81x26mm covers for price labels (not included).



50.854 x25 

**INFORMATION**

\*mm

With 1 opening cover for place 82x56mm labels (not included).

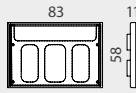

50.855 x25 

### CASSETTE UNIT PRICE HOLDER



**DIGIT BOOKLET PACK**

Each pack contains 6 Digit Booklets (3x Model A + 1x Model B + 1x Model C + 1x Model D) suitable for Ref. 50.853.

50.856 x25 

**INFORMATION**

\*mm

With a 81x26mm cover and 6 digit sections. 6 Digit Booklets included.

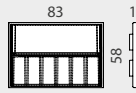

50.853 x25 



### SNAIL CLIP

**INFORMATION**

\*mm

Suitable for 50.824 and 50.828 label system accessories.



SNAIL CLIP SIZE  
50.825 45x65mm x25 

### CASSETTE CONNECTOR

**INFORMATION**

\*mm

Suitable for Card Clip (Ref. 50.823).



CONNECTOR SIZE  
50.828 25x10x7mm x50 

### ROD HOLDER CONNECTOR

**INFORMATION**

\*mm

Fits with 50.810, 50.853, 50.854 and 50.855 label system accessories.



CONNECTOR SIZE  
50.824 19x11x12mm x50 

### SHARP PIN

**INFORMATION**

\*mm

Suitable for Card Clip (Ref. 50.823).



SHARP PIN SIZE  
50.826 85x22mm x50 

### ICE PIN

**INFORMATION**

\*mm

Ice Pin features a card hook. Suitable for Card Clip (Ref. 50.823).



ICE PIN SIZE  
50.827 185x22mm x50 

### STEM PIN

**INFORMATION**

\*mm

Suitable for Cassette Price Holder (Ref. 50.853, 50.854, 50.855).



STEM PIN SIZE  
50.830 155x19mm x50 

**LABEL HOLDER DETAILS**

**INFORMATION** \*mm

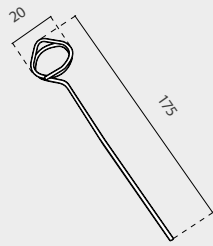

This metal Long Pin is ideal for use in garden centers or supermarkets as label holder.

LONG PIN SIZE

12.461	175x20mm	x100 
--------	----------	--

**LONG PIN LABEL HOLDER**



**LABEL HOLDER DETAILS**

**INFORMATION** \*mm



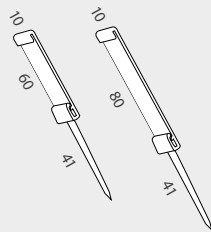

REF 12.209

REF 12.210



White Spike available in 2 label sizes. Ideal for supermarkets. Holds material up to 0.8mm.

ROD HOLDER LABEL SIZE

12.209	60mm	x100 
12.210	80mm	x100 

**SPIKE LABEL HOLDER**



**LABEL HOLDER DETAILS**

**INFORMATION** \*mm

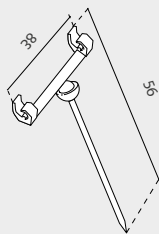

This white pin is ideal for using in garden centers or supermarkets. 1mm maximum label thickness.

LONG PIN SIZE

12.462	38x56mm	x100 
--------	---------	--

**PIN LABEL HOLDER**



PRICE HOLDER DETAILS



INFORMATION

DIMENSIONS \*mm

This Clip Holder is made of transparent plastic and it is suitable for attaching cards, coupons, for adding promotions, price labels, etc. It adapts easily to shoes, kitchenware, crockery, tools, bags and any others similar products. Widely used in supermarket, shops, retails, shelves for attracting more customers' eyesights.

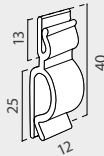

CLIP LABEL	SIZE	
12.211	12x40mm	x100 

CLIP LABEL HOLDER



LABEL HOLDER DETAILS

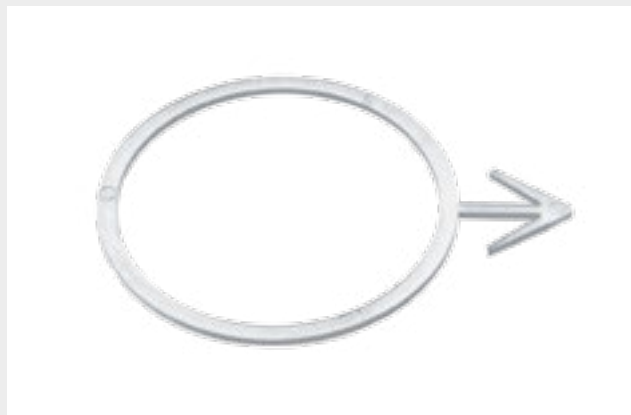

INFORMATION

DIMENSIONS \*mm

This Ring Holder is made of transparent plastic and it is a cheap and effective way for attaching prices and offers to wine bottles or cylindrical products. Its arrowhead is flexible and allows the fastening of most tags or price labels. Frequently employed in supermarkets, malls, retail stores or at wine cellars.



RING LABEL	DIAMETER	
12.296	Ø40mm	x100 

RING LABEL HOLDER









## COLORED PRICE CARDS



YELLOW	COLOR	SIZE		
17.034Y		85x85mm	x10 	
17.035Y		115x115mm	x10 	
17.036Y		160x160mm	x10 	







GREEN	COLOR	SIZE		
17.034G		100x75mm	x10 	
17.035G		145x105mm	x10 	
17.036G		190x145mm	x10 	







PINK	COLOR	SIZE		
17.034P		100x75mm	x10 	
17.035P		145x105mm	x10 	
17.036P		190x145mm	x10 	



ORANGE	COLOR	SIZE		
17.034O		100x70mm	x10 	
17.035O		145x100mm	x10 	
17.036O		190x145mm	x10 	

## SQUARE STAR



SQUARE STAR	SIZE		
17.000	S 100x70mm	x10 	
17.001	M 135x100mm	x10 	
17.002	L 160x160mm	x10 	
17.003	XL 185x130mm	x10 	
17.004	XXL 240x180mm	x10 	





## "NEW" STAR



NEW	SIZE		
17.010	S 90x65mm	x10 	
17.011	M 140x100mm	x10 	
17.012	L 165x130mm	x10 	
17.013	XL 190x135mm	x10 	
17.014	XXL 250x175mm	x10 	





## "V" EXPLOSION



EXPLOSION	SIZE		
17.005	S 95x70mm	x10 	
17.006	M 140x95mm	x10 	
17.007	L 150x120mm	x10 	
17.008	XL 190x135mm	x10 	
17.009	XXL 230x170mm	x10 	





## "V" STAR



STAR	SIZE		
17.020	S 100x80mm	x10 	
17.021	M 140x100mm	x10 	
17.022	L 165x115mm	x10 	
17.023	XL 190x130mm	x10 	
17.024	XXL 240x180mm	x10 	





## "OK" CLOUD



YELLOW "OK"	SIZE		
17.015	S 100x70mm	x10 	
17.016	M 140x100mm	x10 	
17.017	L 165x120mm	x10 	
17.018	XL 190x150mm	x10 	
17.019	XXL 245x175mm	x10 	

## "OK" EXPLOSION



RED "OK"	SIZE		
17.025	S 95x80mm	x10 	
17.026	M 130x110mm	x10 	
17.027	L 155x120mm	x10 	
17.028	XL 180x145mm	x10 	
17.029	XXL 230x175mm	x10 	

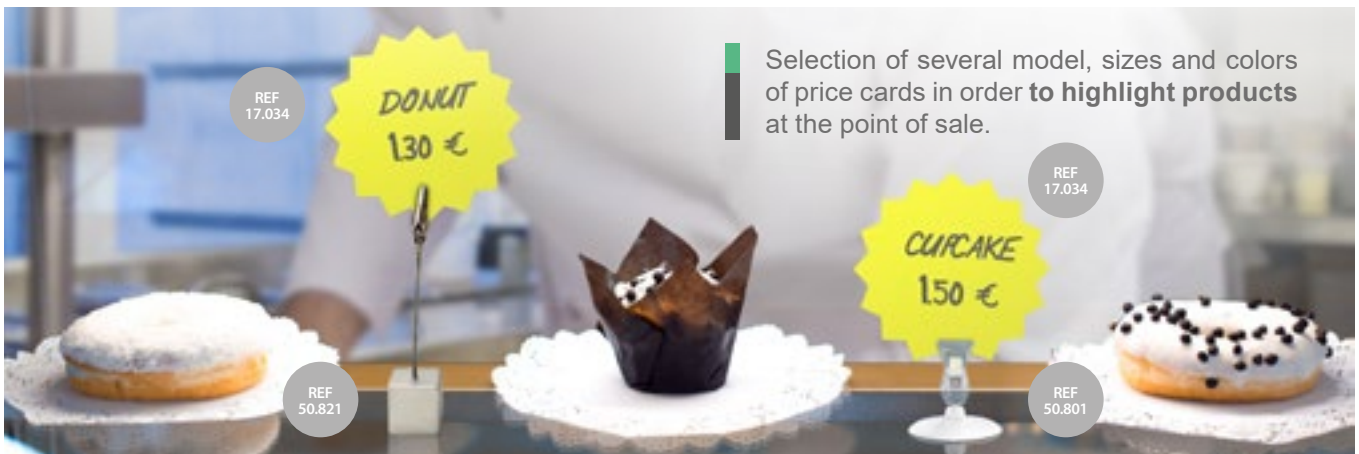

Selection of several model, sizes and colors of price cards in order to highlight products at the point of sale.

REF 17.034

REF 17.034

REF 50.821



REF 50.801

## HOOK DETAILS

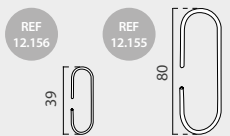
## INFORMATION \*mm



This hook with "C" shape is ideal for hanging plastic strips. 2 lengths of hooks are available.

"C" HOOK	LENGTH		
12.155	80mm	x100	
12.156	39mm	x100	

## "C" METAL HOOK



## HOOK DETAILS

## INFORMATION \*mm



This Strip hook is made of steel and it is ideal for being used with the clip strips.

CLIP HOOK	LENGTH		
12.157	38mm	x100	

## STRIP METAL HOOK



## HOOKS DETAILS

## INFORMATION \*mm



"S" shape Hook made of steel. 2 sizes available. Ideal for hanging promotional signage from ceiling or wire baskets.

"S" HOOK	LENGTH	Ø WIRE	
12.152	27mm	Ø1.1mm	x100 
12.154	120mm	Ø2mm	x100 

## "S" METAL HOOK



## RINGS DETAILS

## INFORMATION \*mm

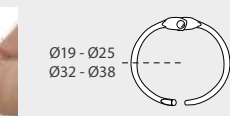
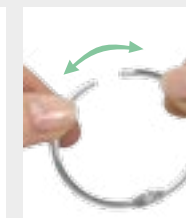

Metal ring with fast click closing. There are 4 diameters available. It is very used for hanging signage at points of sale.

METAL RING	DIAMETER		
12.160	Ø19mm	x100	
12.161	Ø25mm	x100	
12.162	Ø32mm	x100	
12.163	Ø38mm	x100	

## METAL RING

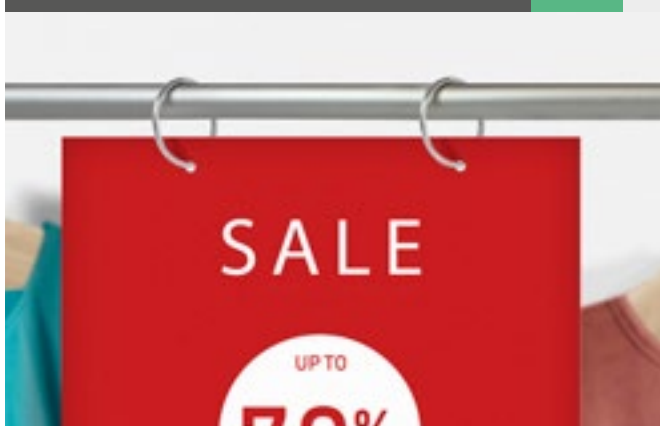



## RINGS DETAILS

## INFORMATION

## DIMENSIONS \*mm



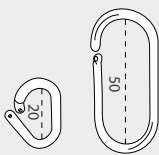

This oval white plastic ring is available in 50mm and 20mm length. It features a click closing for a better attachment. It is ideal for hanging signage, baskets and objects at retail stores or at the supermarkets.



REF 12.158

REF 12.380

ROUND RING	LENGTH		
12.380	50mm	x100	
12.158	20mm	x200	

## OVAL PLASTIC RING



## HOOK DETAIL

## INFORMATION

## DIMENSIONS \*mm



This white plastic hook is 47mm length. It features an "S" shape for 2 diameters for being used with 6mm and 16mm wire. It is ideal for hanging signage, baskets and objects at retail stores or at the supermarkets.

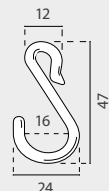

47 "S"

SIZE

12.377	24x47mm	x100	
--------	---------	------	--

## STRIP PLASTIC HOOK



## HOOK DETAIL

## INFORMATION

## DIMENSIONS \*mm



This white plastic hook is 55mm length. It features an "S" shape for 2 diameters for being used with wires up to Ø14mm. It is ideal for hanging signage, baskets and objects at retail stores or at the supermarkets.

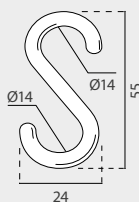

55 "S"

SIZE

12.293	24x55x5mm	x100	
--------	-----------	------	---

## "S" PLASTIC HOOK

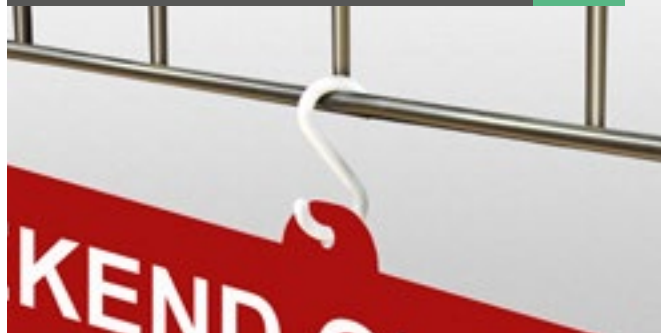

## RINGS DETAILS

## INFORMATION

## DIMENSIONS \*mm





This light round white plastic ring closes easily thanks its click system. Featuring 2 diameters of ring available (15mm or 23mm). They are ideal for hanging signage, baskets or objects at retail stores or at the supermarkets.



REF 12.159



REF 12.304

ROUND RING	DIAMETER		
12.159	Ø 15mm	x100	
12.304	Ø 23mm	x100	

## PLASTIC RING



**PRONG DETAIL**      **INFORMATION**      **DIMENSIONS**      \*mm



This 43mm length prong has a 25x28mm adhesive pad so it is ideal for presenting last minute add-on items, also is perfect for presenting gift cards, hanging posters or promotional showcards on your cardboard display.

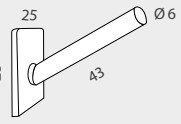

PLASTIC PRONG	SIZE		
12.485	28x25x43mm	x100	

## SMALL PLASTIC PRONG





**HOOKS DETAILS**      **INFORMATION**      **DIMENSIONS**      \*mm

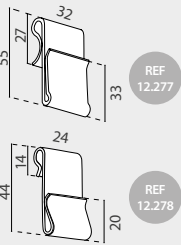

The white double Clip Hook is suitable for cardboard, wire, glass... Ideal for representing last minute add-on items or adding promotional products on your display. 2 sizes of clip available.



DOUBLE CLIP	LENGTH		
12.277	55mm	x100	
12.278	44mm	x100	

## DOUBLE COUPON HOOK



**HOOK DETAIL**      **INFORMATION**      **DIMENSIONS**      \*mm



Clip-on over cardboard displays. "S" Hook is ideal for presenting last minute add-on items, also for presenting gift cards or adding promotional products on your display.



HOLDER "S"	HOOK SIZE		
12.074	24x32mm	x100	

## "S" COUPON HOOK



**HOOK DETAIL**      **INFORMATION**      **DIMENSIONS**      \*mm



Clip-on over cardboard displays. "D" Hook is ideal for presenting last minute add-on items, also for presenting gift cards or adding promotional products on your display.



HOLDER "D"	LENGTH		
12.279	55mm	x100	

## "D" COUPON HOOK



**CLIP DETAIL**      **INFORMATION**      **DIMENSIONS** \*mm



This 27x10mm metallic clip with hole features a strength clamp. This clip is ideal for holding offer posters, shopping signage or promotional banners, at any point of sale.

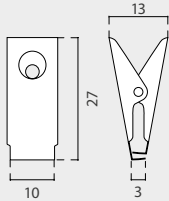

METAL CLIP	SIZE		
12.164	10x27mm	x100	

## METAL CLIP







**CLIPS DETAIL**      **INFORMATION**      **DIMENSIONS** \*mm

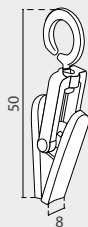

Ring Clip is made of plastic and features an open ring for being used on wires. 2 colors of clip available (black and transparent). Ideal to hang removable signage.



RING CLIP	SIZE		
12.374	 50x8mm	x100	
12.375	 50x8mm	x100	

## RING CLIP





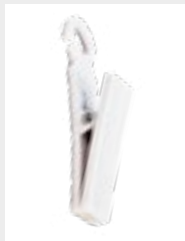

**CLAMP DETAIL**      **INFORMATION**      **DIMENSIONS** \*mm

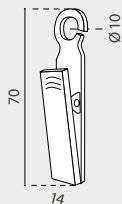

The Open Ring Clamp is made of plastic and it is available in 2 colors. It is ideal for holding signage, offer posters or shopping promotions at supermarkets, stores or at any point of sale.



OPEN RING	SIZE		
12.476	 14x70mm	x50	
12.477	 14x70mm	x50	

## OPEN RING CLIP



**CLAMP DETAIL**      **INFORMATION**      **DIMENSIONS** \*mm



This big transparent clamp features 2 rotary axes for displaying several angles of vision, also a strength 60mm clamp which is ideal for holding signage, offer posters or shopping promotions at supermarkets, stores or at any point of sale.

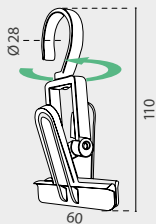

ROTATING HOOK	SIZE		
12.475	60x110mm	x50	

## ROTATING HOOK CLAMP



## HOLDER DETAILS

## DIMENSIONS \*mm

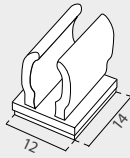

## INFORMATION

This 12x14mm holder with adhesive base is suitable for standard pens or pencils. Quick and simple use. Ideal for the academies, schools or for the offices...

PEN CLAMP	BASE SIZE		
12.182	12x14mm	x100	

## PEN CLIP HOLDER

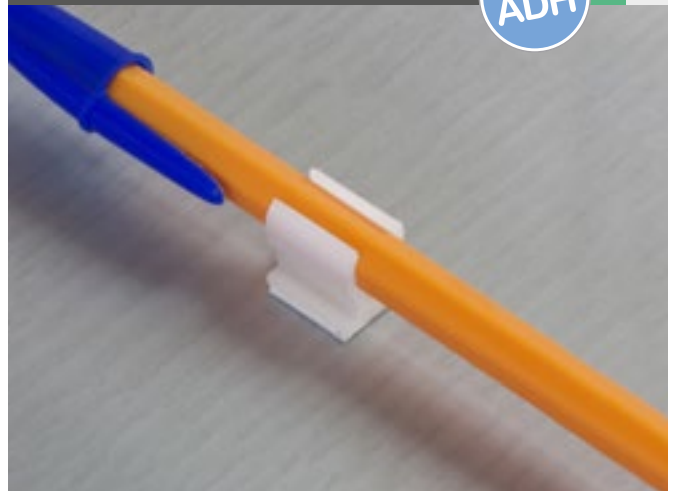

## HOLDER DETAILS

## DIMENSIONS \*mm

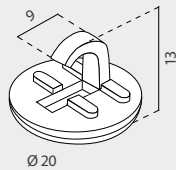

## INFORMATION

This pen or cable white holder features a Ø20mm rounded adhesive base. It is also suitable for the most pens and pencils (up to Ø8mm).

PEN GUIDE	BASE SIZE		
12.448	Ø20mm	x100	

## PEN GUIDE HOLDER



## HOLDERS DETAILS

## DIMENSIONS \*mm

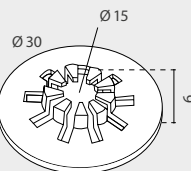

## INFORMATION

This CD holder has a Ø30mm rounded adhesive base. 3 different colors available.

CD HOLDER	COLOR	DIAMETER		
12.486		White	Ø30mm	x100 
12.487		Clear	Ø30mm	x100 
12.488		Black	Ø30mm	x100 

## CD HOLDER

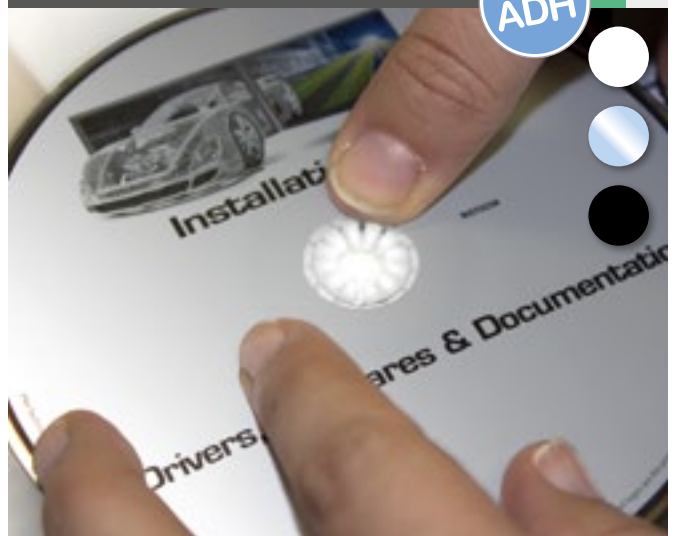

## DISCS DETAILS

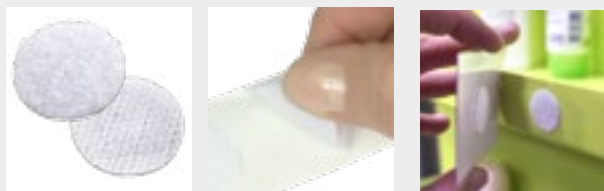

## INFORMATION

These adhesive adjustable tape discs are easy to use and they are durable and strong. Allows an easily changing of signage position thanks its male and female genuine VELCRO® brand sides. 3 diameters available. Ideal for being used with paper crafts, cardboard or displays.

TAPE DISCS	DIAMETER		
12.505	♂ 10mm	x1000 	
12.506	♀ 10mm		
12.507	♂ 20mm	x1000 	
12.508	♀ 20mm		
12.509	♂ 25mm	x1000 	
12.510	♀ 25mm		

## ADJUSTABLE TAPE DISCS

ADH

velcro





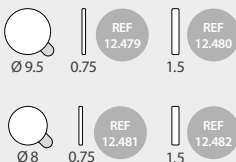

## DISC DETAILS

## DIMENSIONS \*mm



## INFORMATION

This double magnetic disc has adhesive on the back and it is ideal as fastener.

ADHESIVE DISC	SIZE		
12.479	Ø9.5x0.75mm	x100 	
12.480	Ø9.5x1.5mm	x100 	
12.481	Ø8x0.75mm	x100 	
12.482	Ø8x1.5mm	x100 	

## DOUBLE MAGNETIC DISC

ADH



## TETHER DETAILS

## DIMENSIONS \*mm

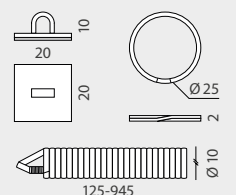

## INFORMATION

A low cost, elastic holder for graphics. 2 rings and 2 adhesive pads are included.

TETHER	CABLE LENGTH	MAXIMUM LENGTH	
12.539	125-945mm	1000mm	x50 

## COILED TETHER

ADH



## TIE DETAILS



## INFORMATION

\*mm

This transparent cable tie holder is made of plastic and it is ideal for attaching price labels on wire shelves or promotion card to displays. It has 55mm length.

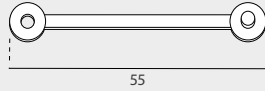

CABLE TIE	LENGTH		
12.376	55mm	x100	

## CABLE TIE

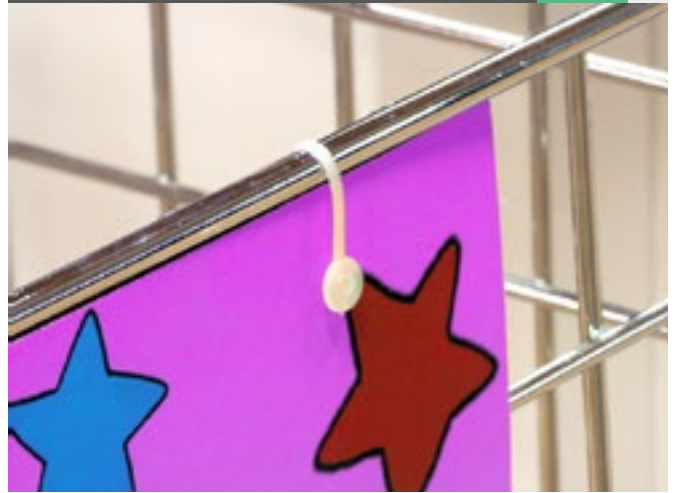

## CORD DETAILS



## INFORMATION

\*mm

Ø2.5mm black elastic cord with metal ends, ideal for attaching promotion cards or price labels.



ELASTIC CORD	SIZE		
12.502	Ø 2.5x100mm	x100	
12.503	Ø 2.5x150mm	x100	
12.504	Ø 2.5x200mm	x100	

## ELASTIC CORD



## CHAIN DETAILS

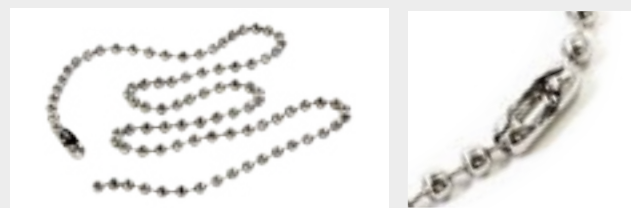

## INFORMATION

Ø2.4mm ball chain available in 3 lengths. It is ideal for hanging posters, for poster rails or attaching promotion cards and price labels to the products.

BALL CHAIN	SIZE		
12.489	Ø 2.4x100mm	x50	
12.490	Ø 2.4x500mm	x50	
12.491	Ø 2.4x1000mm	x50	

## BALL CHAIN

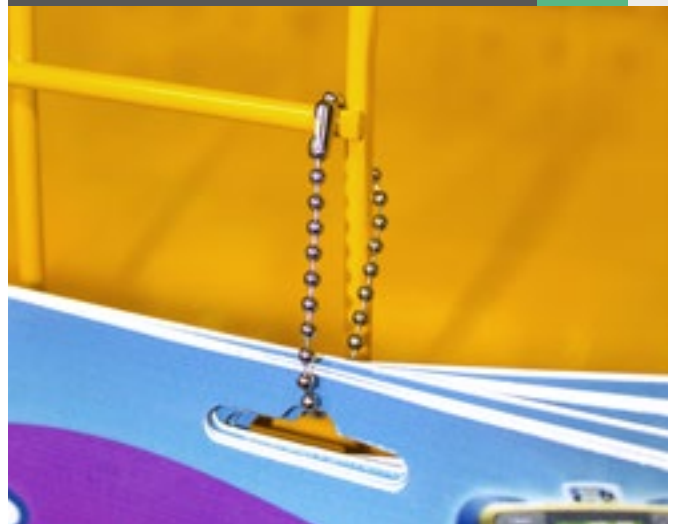

## LOOP PIN DETAILS





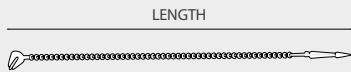

### INFORMATION

\*mm

This flexible and easily adjustable plastic loop pin is beaded for an easy adjustment. It is ideal for attaching the price labels directly to the products.



PLASTIC STRAP	LENGTH		
12.497	3" (76.20mm)	x1000	
12.498	4" (101.60mm)	x1000	
12.499	5" (127.00mm)	x1000	
12.500	6" (152.40mm)	x1000	
12.501	7" (177.80mm)	x1000	

## PLASTIC BEADED LOOP PIN



## LOOP PIN DETAILS

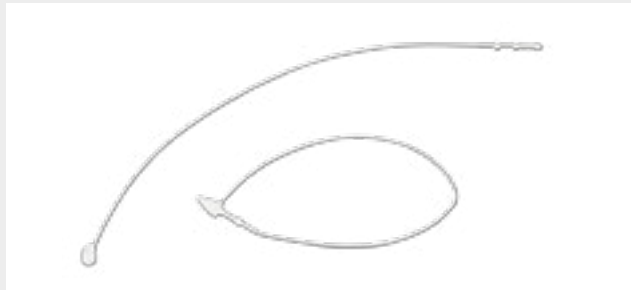

### DIMENSIONS

\*mm

This flexible and easily adjustable plastic loop pin is one of the most used attaching systems at retail stores. It is ideal for attaching the price labels directly to the products.



BEADED STRAP	SIZE		
12.492	3" (76.20mm)	x1000	
12.493	4" (101.60mm)	x1000	
12.494	5" (127.00mm)	x1000	
12.495	6" (152.40mm)	x1000	
12.496	7" (177.80mm)	x1000	

## PLASTIC LOOP PIN



# HANGING SOLUTIONS Ceiling Hooks

Full range of **hanging solutions** with different attachment systems like magnets, adhesives, suction cups, clips, etc... Ideal for displaying **signage** from **ceiling** in high traffic areas at point of sale.

## BUTTON DETAILS





## INFORMATION

\*mm

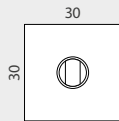
This low cost white polypropylene ceiling button has a rotating closed hook and self adhesive foam for a fast application. It is squared and 10mm height. Also, it accepts Ø5mm wire hooks. Ideal for attaching promotions from the ceiling.



360° SQUARED SIZE

12.113 30x30mm x100  

## 360° ADHESIVE SQUARED BUTTON



## BUTTON DETAILS



## INFORMATION

\*mm

This low cost white polypropylene ceiling button features a rotating closed hook and self adhesive foam side for a fast application. It is 25mm height. Also, it accepts 6mm diameter wire hooks. Ideal for attaching promotions from the ceiling.

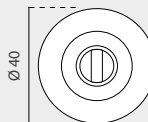

360° ROUNDED DIAMETER

12.384 Ø40mm x100  

## 360° ADHESIVE ROUNDED BUTTON



## BUTTON DETAILS



## INFORMATION

\*mm

This low cost white polypropylene ceiling button features a closed hook and self adhesive foam side for a fast application. It is squared and it is 10mm height. Also, it accepts 5mm diameter wire hooks. Ideal for attaching promotions from the ceiling.

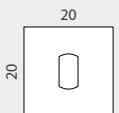

SQUARED SIZE

12.129 20x20mm x100 

## ADHESIVE SQUARED BUTTON





## BUTTON DETAILS



## INFORMATION

\*mm

This low cost white polypropylene ceiling button features a closed hook and self adhesive foam side for a fast application. It is squared and it is 10mm height. Also, it accepts 5mm diameter wire hooks. Ideal for attaching promotions from the ceiling.

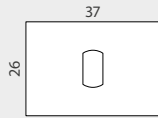

RECTANGULAR SIZE

12.130 37x26mm x100 

## ADHESIVE RECTANGULAR BUTTON



## BUTTON DETAILS



## INFORMATION

\*mm

This low cost white polypropylene ceiling button features a closed hook and self adhesive foam side for a fast application. It is rounded and it is 9mm height. Also, it accepts 5mm diameter wire hooks. Ideal for attaching promotions from the ceiling.

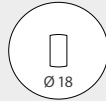

ROUNDED DIAMETER

12.301 Ø18mm x100 

## ADHESIVE ROUNDED BUTTON



## BUTTON DETAILS



## INFORMATION

\*mm

This low cost white polypropylene ceiling button features a closed hook and self adhesive foam side for a fast application. It is oval and it is 9mm height. Also, it accepts 5mm diameter wire hooks. Ideal for attaching promotions from the ceiling.

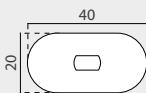

OVAL SIZE

12.368 40x20mm x100 

## ADHESIVE OVAL BUTTON



## HOOK DETAIL

## DIMENSIONS \*mm



## INFORMATION

Squared adhesive button and open hook. Ideal for attaching wires from ceiling.

STRAIGHT	SIZE		
12.131	24x24mm	x100	

## ADHESIVE STRAIGHT HOOK



## BUTTON DETAIL

## DIMENSIONS \*mm



## INFORMATION

Squared adhesive button with open ring hook. Ideal for attaching from ceiling.

RING	SIZE		
12.447	25x25mm	x100	

## ADHESIVE RING BUTTON



## CLIP DETAIL

## DIMENSIONS \*mm



## INFORMATION

Transparent Clip with hole for wire hooks. Ideal for attaching wires from ceiling.

VERTICAL	SIZE		
12.132	23x20mm	x100	

## CEILING VERTICAL CLIP



## CLIP DETAIL

## DIMENSIONS \*mm



## INFORMATION

Transparent clip with close Ø5mm hook. It is ideal for attaching wires from ceiling.

HORIZONTAL	SIZE		
12.133	20x20mm	x100	

## CEILING HORIZONTAL CLIP



## HOOK DETAILS

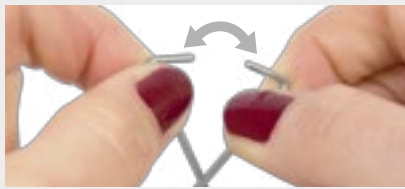

### INFORMATION

This silver clip with fish shape is ideal for holding promotions, offers, banner posters or signage with wire hooks from the ceiling.

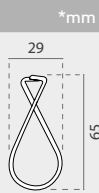

\*mm

FISH HOOK

SIZE

12.136

65x29mm

x100 

## FISH HOOK



## HOOK DETAILS



### INFORMATION

This wire clip, thanks to its shape is ideal for holding promotions, offers, for posters or signage with wire hooks from ceiling.



\*mm

SPIDER HOOK

SIZE

12.135

75x20mm

x100 

## SPIDER HOOK

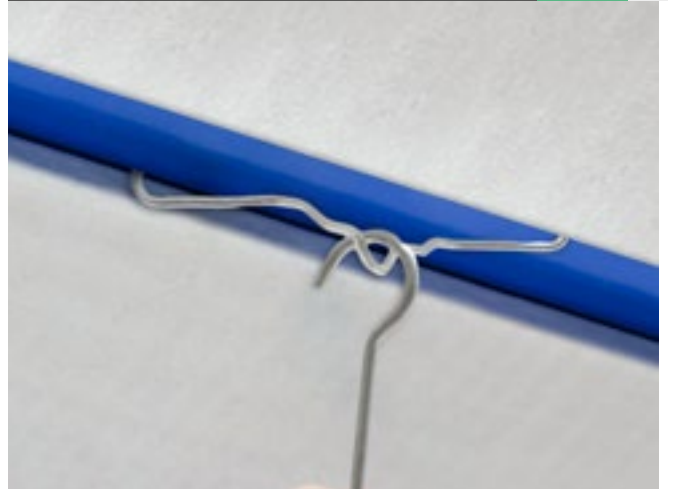

## HOOK DETAILS



### INFORMATION

This silver clip with bat shape is ideal for holding promotions, offers, banner posters or signage with wire hooks from the ceiling.

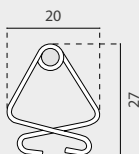

\*mm

BAT HOOK

SIZE

12.387

20x27mm

x100 

## BAT HOOK





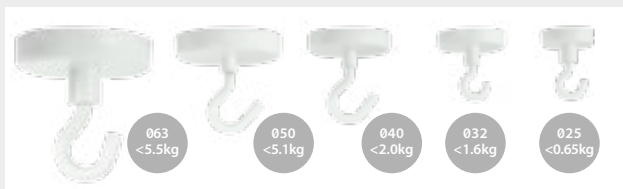

## HOOK DETAILS



## INFORMATION

This magnetic round base has rounded opening hook. With 5 sizes. They are suitable with any kind of metallic furniture. Ideal to hang promotions from the ceiling.

ROUND BASE	DIAMETER	WEIGHT SUPPORTED	
12.167	Ø25mm	<650 g	x25 
12.347	Ø32mm	<1600 g	x20 
12.348	Ø40mm	<2000 g	x10 
12.349	Ø50mm	<5100 g	x10 
12.350	Ø63mm	<5500 g	x10 

## ROUND BASE MAGNETIC HOOK



## HOOK DETAILS

## DIMENSIONS \*mm



## INFORMATION

This Ø24mm white round base is made of steel with neodymium core. It's suitable with any kind of metallic surface thanks to its magnetic neodymium strength.

NEODYMIUM	DIAMETER	HEIGHT	
80403001	Ø24mm	23mm	x50 

## ROUND BASE NEODYMIUM HOOK

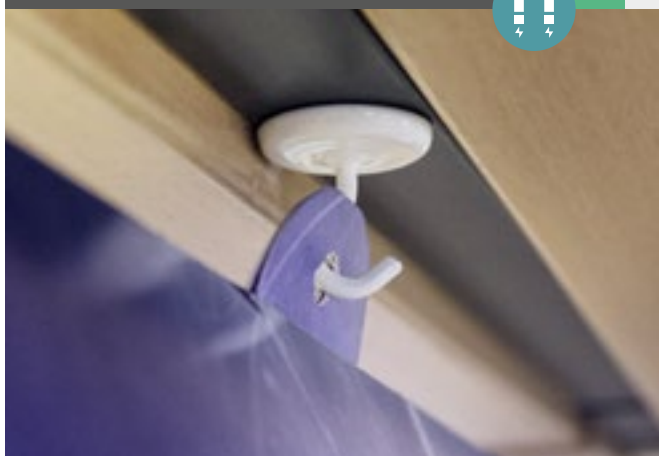

## HOOK DETAILS

## DIMENSIONS \*mm



## INFORMATION

The 28x14mm magnetic base with 13mm high closed hook is suitable for attaching promotional banners or supermarket poster on any kind of metal surface.

BRICK MAGNET	SIZE	
12.478	28x14x38mm	x50 

## BRICK BASE MAGNETIC HOOK

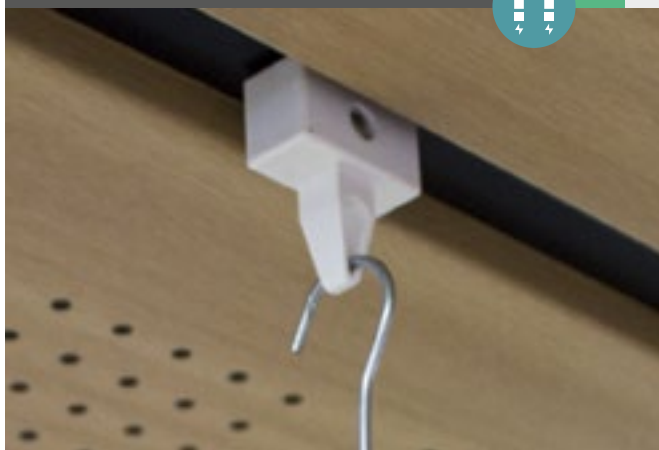

## HOOK DETAILS

## DIMENSIONS \*mm

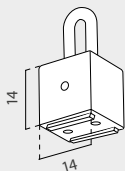

## INFORMATION

This magnetic cube with closed hook is ideal for hanging promotions from ceiling.

SQUARE SIZE

12.165 14x14mm x50 

## SQUARE BASE MAGNETIC HOOK



## HOOK DETAILS

## DIMENSIONS \*mm

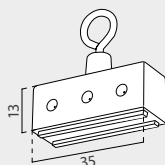

## INFORMATION

This double magnetic base is ideal for hanging promotions from ceiling.

RECTANGLE SIZE

12.166 35x13mm x50 

## RECTANGLE BASE MAGNETIC HOOK

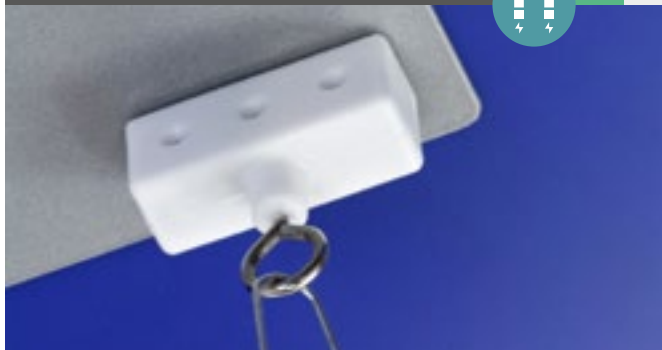

## HOOK DETAILS

## DIMENSIONS \*mm

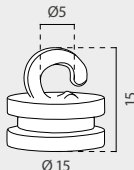

## INFORMATION

This small magnetic open hook is ideal for hanging promotions from ceiling.

OPEN MINI SIZE

12.386 Ø15x15mm x50 

## MINI OPEN MAGNETIC HOOK



## HOOK DETAILS

## DIMENSIONS \*mm

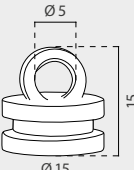

## INFORMATION

This small magnetic closed hook is ideal for hanging promotions from ceiling.

CLOSED MINI SIZE

12.385 Ø15x15mm x50 

## MINI CLOSED MAGNETIC HOOK



## HOOK DETAILS

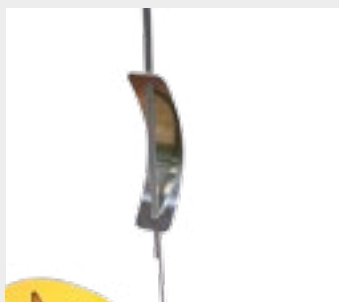

### INFORMATION

\*mm

This metallic with silver finish Hook features an adjustable length system which allows a maximum length of 2000mm. Made of steel, this hook is ideal for being used for displaying large offer banners, temporary sales or banners from the ceiling at the supermarkets, at retail stores or at malls.

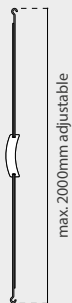

ADJUSTABLE	LENGTH	
12.151	1000-2000mm	x50 

## ADJUSTABLE METAL HOOK



## HOOKS DETAILS

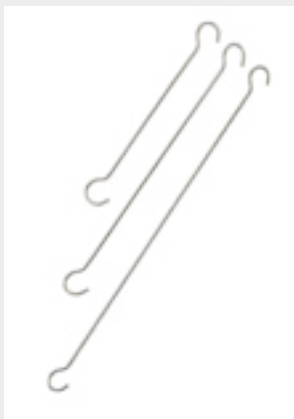







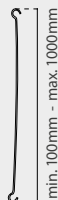



### INFORMATION

\*mm

This bright and galvanised double hook features 10 sizes available. Ideal for displaying offers, sales or temporary banners from the ceiling at retail stores supermarkets or malls.



DOUBLE	SIZE	
12.141	100mm	x50 
12.142	150mm	x50 
12.143	200mm	x50 
12.144	300mm	x50 
12.145	400mm	x50 
12.146	500mm	x50 
12.147	600mm	x50 
12.148	750mm	x50 
12.149	900mm	x50 
12.150	1000mm	x50 

## DOUBLE METAL HOOK



## HOOK DETAILS



### INFORMATION

\*mm

This silver finish metallic hook features an adjustable length system thanks its highly resistant nylon wire wich allows a maximum length of 1200mm, so this hook is ideal for displaying large offer banners, or temporary sales from the ceiling at the retail stores.

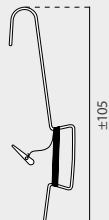

NYLON

12.137

x100 

## METAL HOOK WITH NYLON WIRE

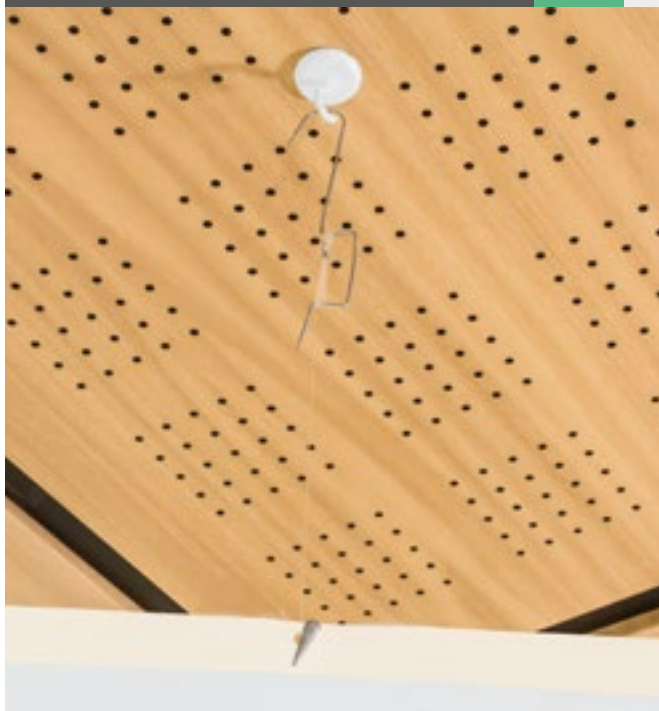

## HOOK DETAILS



### INFORMATION

\*mm

This metallic Hook features an extendible spring system. Made of steel, and with 3 lengths available. This hook is ideal for being used for displaying large offer banners, temporary sales or banners from the ceiling at the supermarkets, at retail stores or at malls.

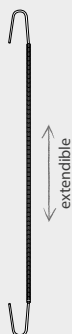

EXTENDIBLE

12.138

160 - 1300mm

x100 

12.139

210 - 1400mm

x100 

12.140

320 - 2500mm

x100 

## EXTENDIBLE WIRE HOOK

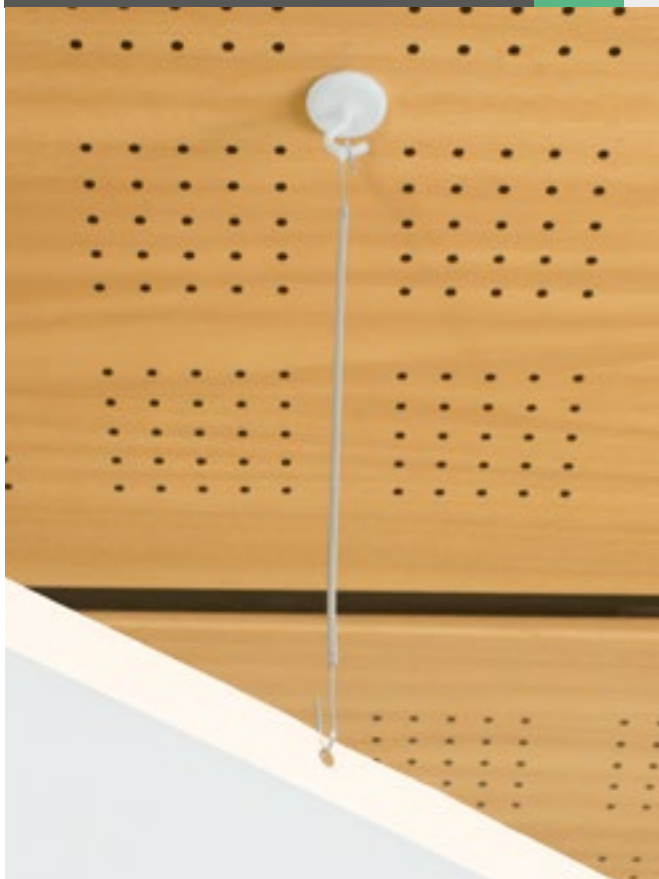

## FIXING SPEARS DETAILS



### INFORMATION

\*mm

The fixing spears are made of lightweight plastic, using it with nylon wire (not included) they are an easy solution for hanging promotional offers from ceiling. Also thanks to its design they are ideal for being used with foamboards signages.



FIXING SPEARS	LENGTH		
12.538	37mm	x100	

## FIXING SPEARS



## NYLON LINE DETAIL



### INFORMATION

This nylon line is ideal for attaching promotional signage from the ceiling.

NYLON LINE	LENGTH	DIAMETER	
12.373	5m	0.5mm	x100 

## NYLON LINE

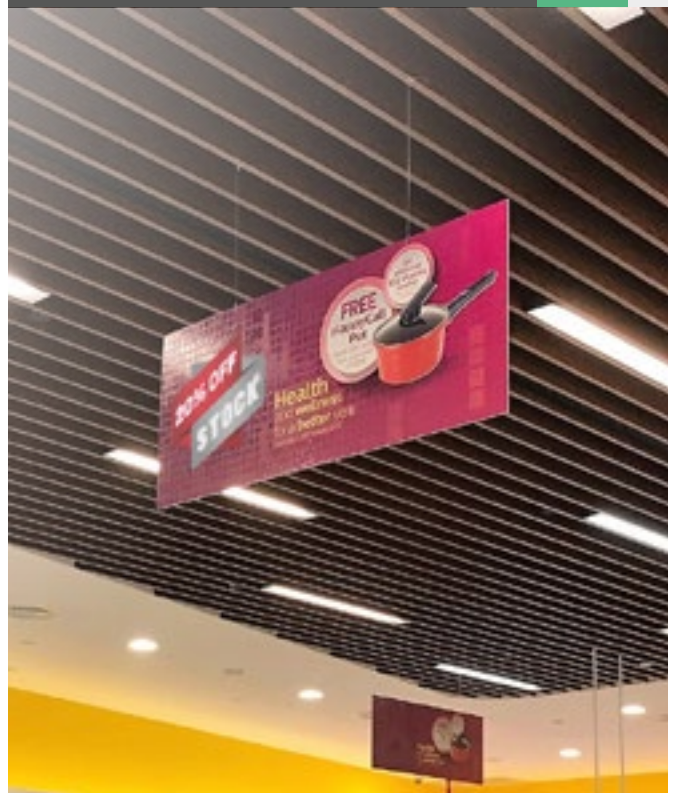



# SUCTION CUPS Suction Cups

## SUCTION CUP DETAILS

DIMENSIONS \*mm



## INFORMATION

With double Ø45mm suction cup for an reinforced attachment. For flat surfaces.

D. THUMB TACK	DIAMETER	
12.171	Ø45mm	x100 

## DOUBLE SUCTION CUP WITH THUMB TACK

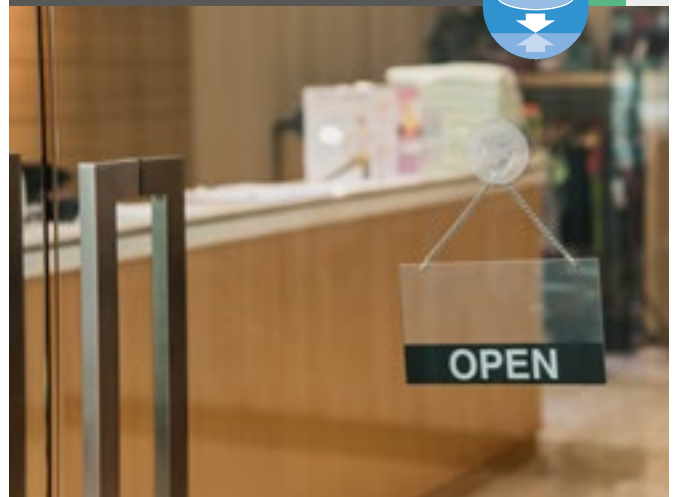

## SUCTION CUP DETAILS

DIMENSIONS \*mm



## INFORMATION

With double Ø45mm suction cup for an reinforced attachment. For flat surfaces.

DOUBLE	DIAMETER	
12.172	Ø45mm	x100 

## DOUBLE SUCTION CUP WITH PLASTIC HOOK

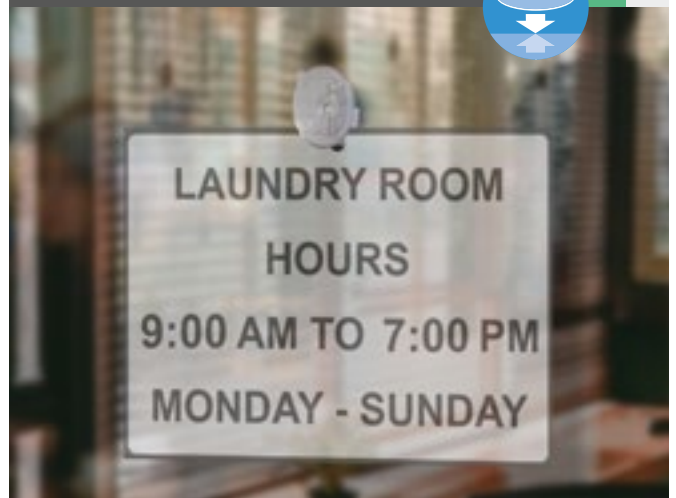

## SUCTION CUP DETAILS

DIMENSIONS \*mm



## INFORMATION

This suction cup has a double suction for reinforced fixing. With a front thumbtack.

DOUBLE	DIAMETER	
12.472	Ø35mm	x100 

## DOUBLE SUCTION CUP

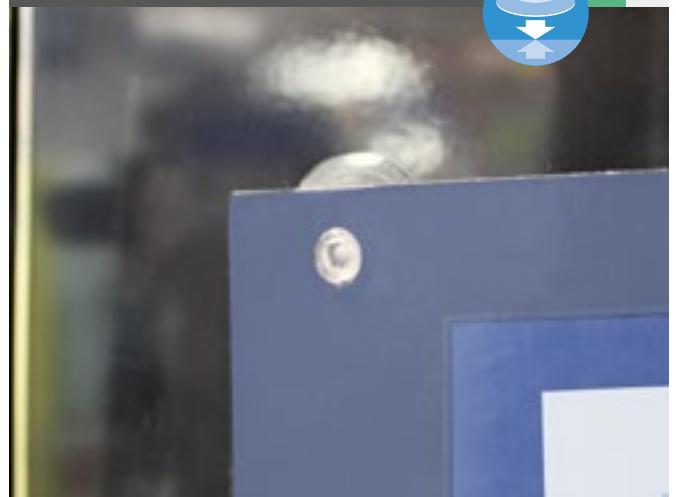

# SUCTION CUPS Suction Cups

## SUCTION CUP DETAILS

## DIMENSIONS \*mm

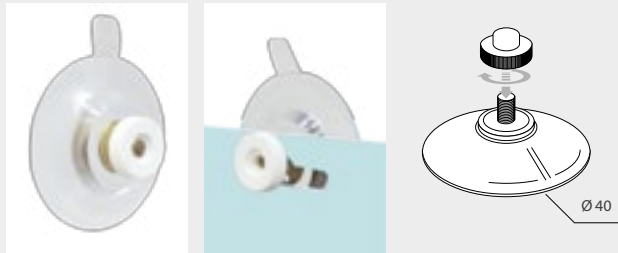

## INFORMATION

Ø40mm diameter suction cup with removable screw for a reinforced fastening.

WITH SCREW	DIAMETER	
12.388	Ø40mm	x100 

## SUCTION CUP WITH SCREW



## SUCTION CUP DETAILS

## DIMENSIONS \*mm

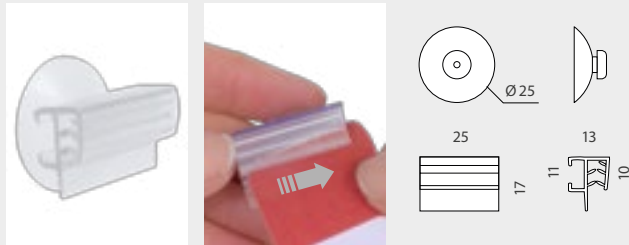

## INFORMATION

Suction cup with lateral gripper that allows the insertion of cards up to 3mm thickness. Ideal for price labels or promotions on shelving.

LATERAL GRIP	DIAMETER	
12.200	Ø25mm	x100 

## LATERAL GRIPPER SUCTION CUP

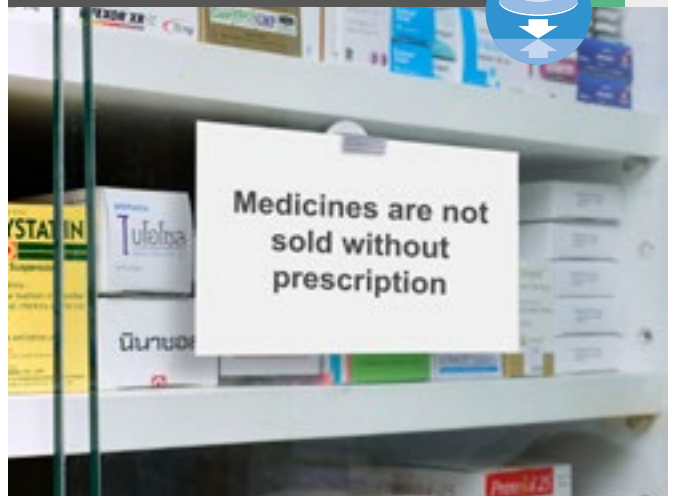

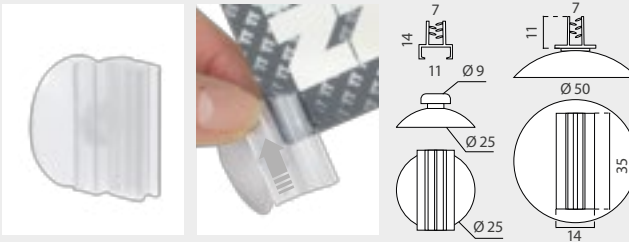

## SUCTION CUP DETAILS

## DIMENSIONS \*mm



## INFORMATION

Suction cup with front gripper that allows the insertion of cards up to 3mm thickness. Ideal for price labels or promotions on shelving.

FRONT GRIP	DIAMETER	
12.201	Ø25mm	x100 
12.473	Ø50mm	x100 

## FRONT GRIPPER WITH THUMB TACK



# SUCTION CUPS Suction Cups

## SUCTION CUP DETAILS

## INFORMATION \*mm

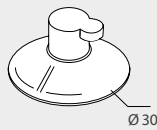
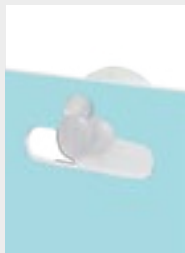

This transparent suction cup sticks to glass or any smooth surface. Good adhesion due to the quality of the molding. It features a plastic hook.

PLASTIC HOOK

DIAMETER

12.168

Ø30mm

x100



## SUCTION CUP WITH PLASTIC HOOK



## SUCTION CUP DETAILS

## INFORMATION \*mm

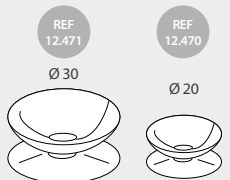

This suction cup has a double suction for a reinforced fixing. With a front cup.

DOUBLE

DIAMETER

12.470

Ø20mm

x100



12.471

Ø30mm

x100



## DOUBLE SIDED SUCTION CUP



## SUCTION CUP DETAILS

## INFORMATION \*mm

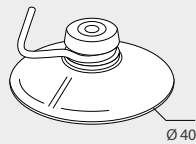

With removable metal hook. Ideal to use directly with the poster, showcard, etc...

METAL HOOK

DIAMETER

12.169

Ø40mm

x100



## SUCTION CUP WITH METAL HOOK

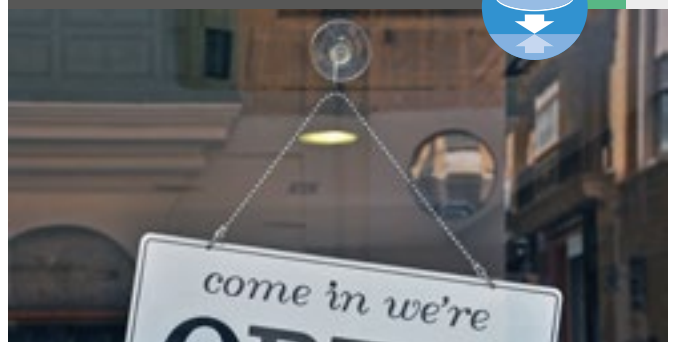

## SUCTION CUP DETAILS

## INFORMATION \*mm

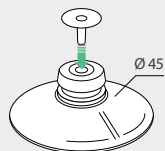

With removable metal hook. Ideal to use directly with the poster, showcard, etc...

THUMB TACK

DIAMETER

12.170

Ø45mm

x100



## SUCTION CUP WITH THUMB TACK



## SUCTION CUP DETAILS





### INFORMATION

### DIMENSIONS

\*mm

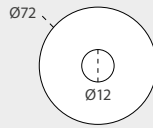
This system allows attach a banner instantly to any window or glass surface, featuring great fixation. 12 units pack. Ideal for boutiques, retail stores or bakeries, for displaying your promos, sales or services right to your storefront window.



BANNER	QTY	N.W	G.W	C.B.M	SIZE
Packing	12	0.4kg	0.45kg	0.04	580x170x40mm
10.798				x12 	

## BANNER SUCTION CUPS



## SUCTION CUP DETAILS



### INFORMATION

### DIMENSIONS

\*mm

This system features great fixation thanks to its Ø120mm reinforced fixing suction cup. It includes an adjustable holder. It is ideal for holding graphs between 3/10mm thickness.

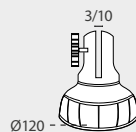

PANEL	QTY	N.W	G.W	C.B.M	SIZE
Packing	1	0.25kg	0.3kg	0.001	125x125x125mm
10.595				Suction Cup Size: Ø120mm	

## PANEL BANNER SUCTION CUP



# SUCTION CUPS Banner Suction Cups

## SUCTION CUP DETAILS

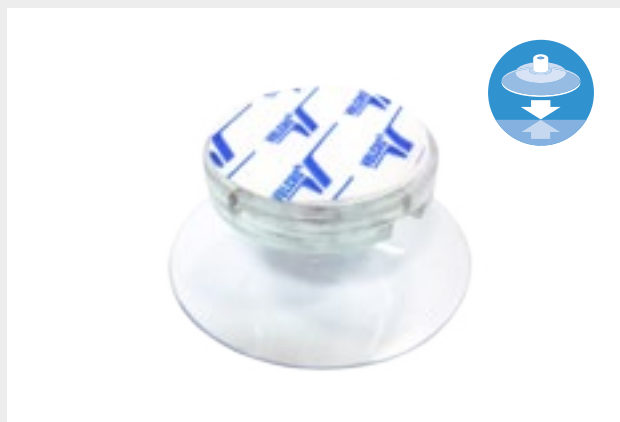

## INFORMATION

## DIMENSIONS \*mm

This system features great fixation thanks its Ø65mm suction cup. The application is really easy, just peel off the adhesive with one of the genuine VELCRO®brand strip and fix it to the graphic or poster. Next, adjust it with the genuine VELCRO®brand strip of the suction cups. Each pack includes 4 units. Ideal for placements where the graphic changing is often needed and the graphic adjustment with genuine VELCRO®brand strip makes it easy.

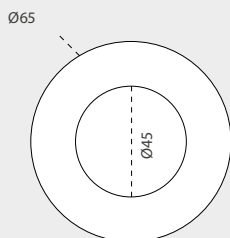

## REMOVABLE BANNER SUCTION CUPS



REMOVABLE	QTY	N.W	G.W	C.B.M	SIZE
Packing	4	0.09kg	0.15kg	0.0008	120x80x80mm
10.779	x4 				

\* VELCRO® is a registered trademark of Velcro BVBA. | VELCRO® est une marque déposée de Velcro Industries B.V. | VELCRO® é uma marca registrada de Velcro Industries B. V. | VELCRO® es una marca registrada de VelcroIndustries B. V.

## GRIPPER DETAILS



## INFORMATION

This useful transparent gripper fits onto any support thanks its back adhesive. It allows the insertion of cards up to 3mm thickness. Ideal for displaying messages at the point of sale

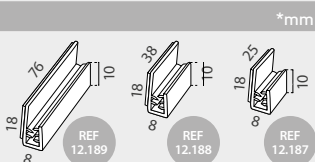

FRONT GRIPPER	LENGTH		
12.187	25mm	x100	
12.188	38mm	x100	
12.189	76mm	x100	

## ADHESIVE FRONT GRIPPER FOR PROFILE



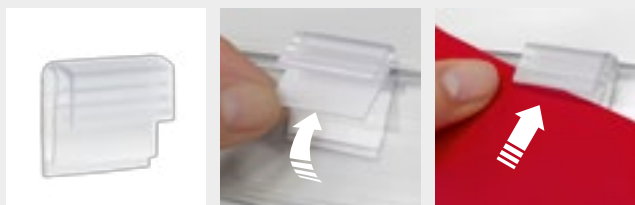

## GRIPPER DETAILS

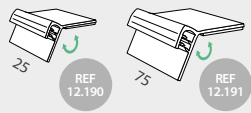

## INFORMATION

This transparent gripper fits onto any support thanks its adhesive foampad. With a hinged base for protecting signage against shocks. It allows the insertion of cards up to 3mm thickness. Ideal for displaying extra-information at the POS line.



HINGED GRIPPER	LENGTH		
12.190	25mm	x100	
12.191	75mm	x100	

## ADHESIVE HINGED GRIPPER FOR PROFILE

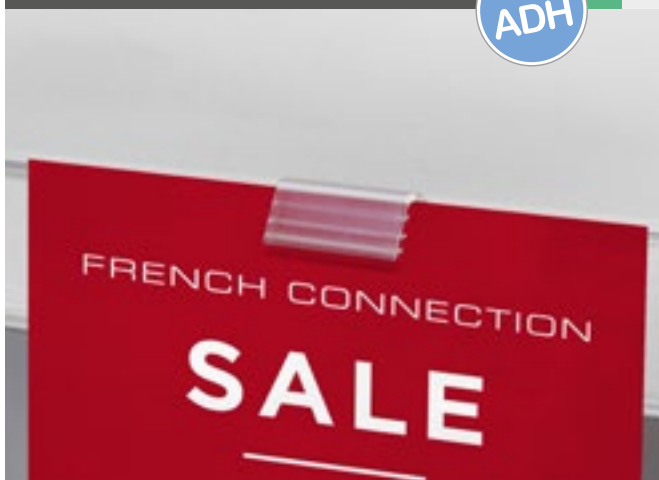



## GRIPPER DETAILS

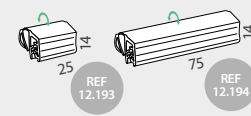

## INFORMATION

This transparent front gripper fits into most of shelving profiles. Featuring a hinged base for protecting signage against shocks. It allows the insertion of cards up to 3mm thickness. Ideal for displaying an extra-information at the sale line.



FRONT HINGED	LENGTH		
12.193	25mm	x100	
12.194	75mm	x100	

## FRONT HINGED GRIPPER FOR PROFILE



## GRIPPER DETAILS



## INFORMATION

\*mm

This transparent gripper fits into most sides of label-holder profiles up to 3mm. It allows the insertion of cards up to 3mm thickness. Ideal for being used as a side signage stopper.

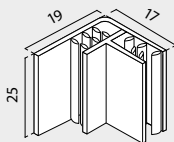

SIDE STOPPER

SIZE

12.453

19x17x25mm

x100 

## SIDE STOPPER GRIPPER FOR PROFILE



## GRIPPER DETAILS



## INFORMATION

\*mm

This transparent gripper fits into most of label-holder profiles up to 3mm. It allows the insertion of cards up to 3mm thickness. Ideal for being used as a stopper signage support at the sale line.

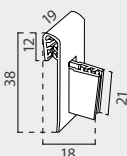

STOPPER GRIPPER

SIZE

12.195

19x38x18mm

x100 

## STOPPER GRIPPER FOR PROFILE



## GRIPPER DETAILS



## INFORMATION

\*mm

This transparent gripper fits into most of shelving profiles. Featuring a hinged base for protecting signage against shocks. It allows the insertion of cards up to 3mm thickness. Ideal for displaying stopper signs, offer messages or price promotions at the sales line.

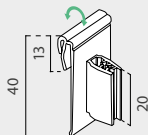

HINGED GRIPPER

HEIGHT

12.192

40mm

x100 

## HINGED STOPPER GRIPPER FOR PROFILE



## GRIPPER DETAILS



## INFORMATION

\*mm

This transparent gripper fits into most of shelving profiles up to 20mm. With a hinged base for protecting signage against shocks. It allows the insertion of cards up to 3mm thickness. Ideal for being used as a stopper signage support at the sale line.

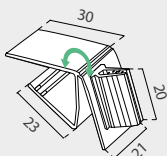

HINGED STOPPER

SIZE

12.523

21x30x20mm

x100 

## HINGED STOPPER GRIPPER FOR SHELF



## GRIPPER DETAILS



## INFORMATION

\*mm

This transparent gripper fits into most of shelving profiles. With a hinged base for protecting signage against shocks. It allows the insertion of cards up to 2mm thickness. Ideal for displaying extra-information.

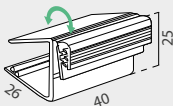

SHELF GRIPPER

LENGTH

12.522

40mm

x100 

## HINGED FRONT GRIPPER FOR SHELF



## GRIPPER DETAILS



## INFORMATION

\*mm

This transparent gripper fits into most of label-holder profiles from  $\pm 27$ mm up to  $\pm 34$ mm thanks to its 2 spring clips. It allows the insertion of cards up to 3mm thickness. Ideal for being used as a stopper signage support at the sale line.

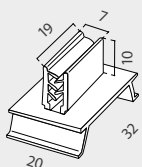

SPRING GRIPPER

BASE SIZE

12.452

20x32mm

x100 

## SPRING GRIPPER FOR PROFILE





## GRIPPER DETAILS

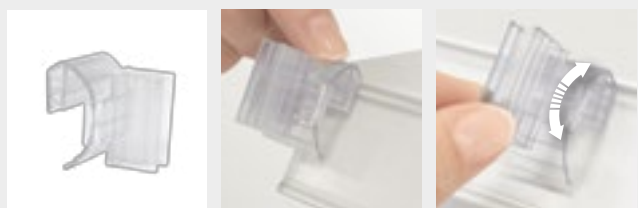

### INFORMATION

\*mm

This transparent gripper fits into most of shelving profiles. It allows the insertion of cards up to 3mm thickness. Featuring an adjustable viewing angle. Ideal for displaying stopper signs, offer messages or price promotions at the sales line.

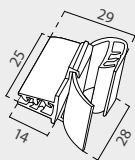

ADJUSTABLE STOPPER

SIZE

12.233

28x29mm

x100



## ADJUSTABLE STOPPER GRIPPER FOR PROFILE



## GRIPPER DETAILS



### INFORMATION

\*mm

This transparent gripper fits into most of wire baskets, or over pole structures up to Ø10mm tubes. It allows the insertion of cards up to 3mm thickness. Ideal as support for displaying signage, light banners or for any promotion at the sale line.

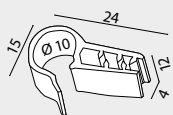

WIRE GRIPPER

SIZE

12.196

12x24x15mm

x100



## WIRE GRIPPER

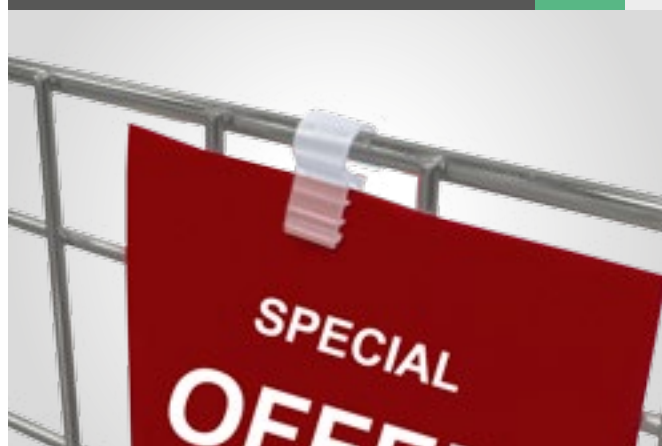

## GRIPPER DETAILS



### INFORMATION

\*mm

This transparent gripper fits onto any support up to 8mm thickness. Also, it allows the insertion of cards up to 3mm thickness. Ideal for attaching signage cards to cardboard displays or to another promotional panel.

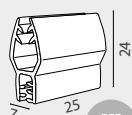

REF 12.369

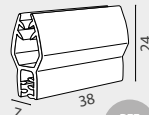

REF 12.370

25 ARROWHEAD

LENGTH

12.369

25mm

x100



38 ARROWHEAD

LENGTH

12.370

38mm

x100



## ARROWHEAD GRIPPER



## GRIPPER DETAILS





### INFORMATION

### DIMENSIONS

\*mm

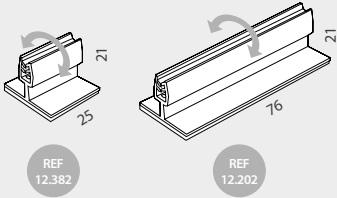
This transparent gripper fits onto any support thanks to its back adhesive foampad. Also, it features a hinged base which protects your promotion card (up to 3mm thickness) against shocks. It is ideal to display messages, signs or promotions at POS.



HINGED GRIPPER	LENGTH		
12.382	25mm	x100	
12.202	76mm	x100	

## HINGED GRIPPER



## GRIPPER DETAILS

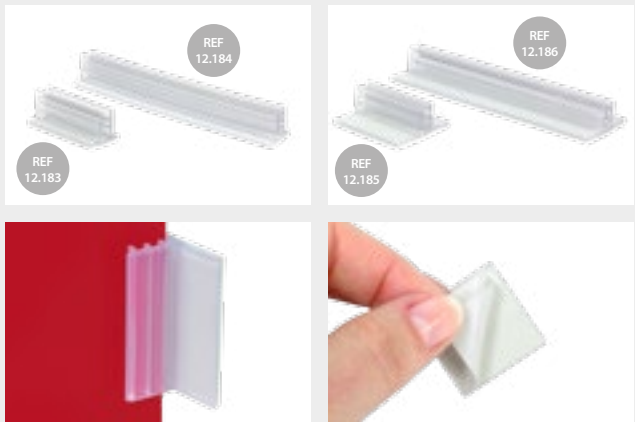

### DIMENSIONS

\*mm



### INFORMATION

This basic gripper fits on any support. It has an adhesive back foam pad for an optimum attachment. There are 4 sizes available with transparent finish. Ideal for displaying signs, price labels, messages or for price promotions at sales lines (up to 3mm thickness).

BASIC GRIPPER	BASE SIZE		
12.183	12x25mm	x100	
12.184	12x75mm	x100	
12.185	25x25mm	x100	
12.186	25x75mm	x100	

## BASIC GRIPPER



GRIPPER DETAILS



DIMENSIONS

\*mm

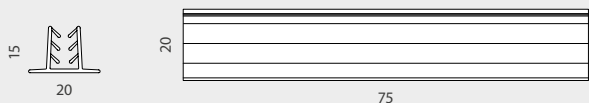

INFORMATION

This adhesive gripper fits on any support. The extra height (15mm) increases the resistance of the grip. Ideal for displaying signs, price cards, messages or labels.

HIGH GRIPPER	SIZE		
12.520	20x75x15mm	x100	

HIGH GRIPPER



GRIPPER DETAILS

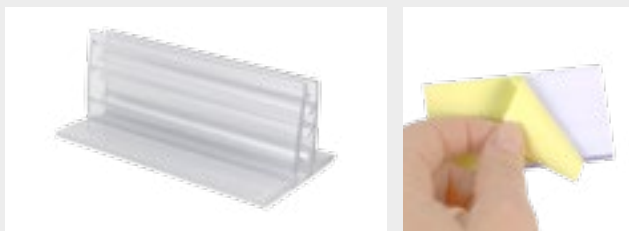

DIMENSIONS

\*mm

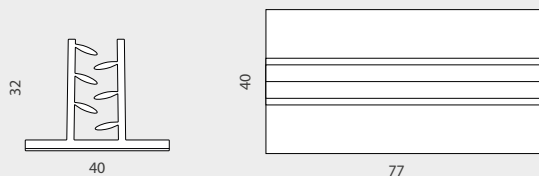

INFORMATION

This Wide Gripper fits on any kind of surface thanks to its adhesive foam pad included. Also its extra width (77mm) provides a solid attachment. Ideal to display signs, messages or price promotions on shelves at sales lines (up to 4mm thickness). With transparent finish.

WIDE GRIPPER	SIZE		
12.346	40x77x32mm	x50	

WIDE GRIPPER



## GRIPPER DETAILS



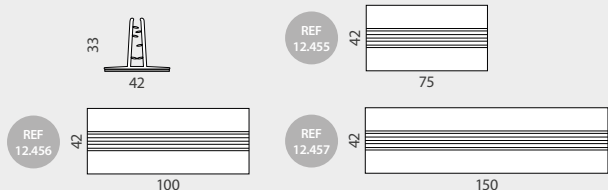

## DIMENSIONS

\*mm



## INFORMATION

The Big Magnetic Gripper fits on any kind of metallic surface. It has a transparent finish. And features 3 widths available. The Big magnetic Gripper is ideal for displaying signs, price labels, messages or price promotions on shelves at the sales lines (up to 5mm thickness).

BIG MAGNETIC	LENGTH	
12.455	75mm	x50 
12.456	100mm	x50 
12.457	150mm	x50 

## BIG MAGNETIC GRIPPER



## GRIPPER DETAILS

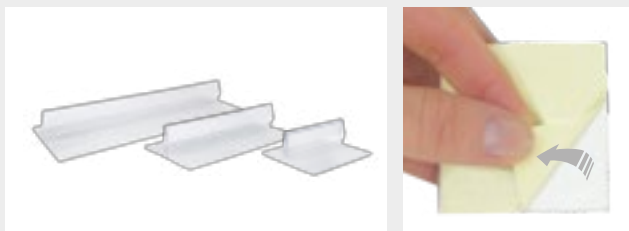

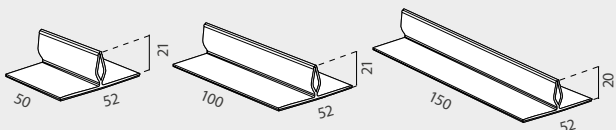

## DIMENSIONS

\*mm



## INFORMATION

The extra size of the Big Gripper provides a solid fixation. It has an adhesive back foam pad for a better fixation and a transparent finish. And features 3 widths available. The Big Gripper is ideal for displaying signs, price labels, messages or price promotions on shelves at the sales lines (up to 2mm thickness).

BIG GRIPPER	LENGTH	
12.378	50mm	x50 
12.379	100mm	x50 
12.383	150mm	x50 

## BIG ADHESIVE GRIPPER



## GRIPPER DETAIL INFORMATION \*mm



This "H" transparent PVC gripper takes up to 2mm thickness cards with 180° angle connection. Ideal for joining cardboard displays, mobiles construction or for displaying signage at POS.

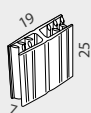

H180 GRIPPER	SIZE		
12.197	19x7x25mm	x100	

## "H" 180° GRIPPER



## GRIPPER DETAIL INFORMATION \*mm



This "V" transparent PVC gripper takes up to 2mm thickness cards with 60° angle connection. Ideal for joining cardboard displays, mobiles construction or for displaying signage at POS.

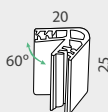

V60 GRIPPER	SIZE		
12.371	20x25mm	x100	

## "V" 60° GRIPPER

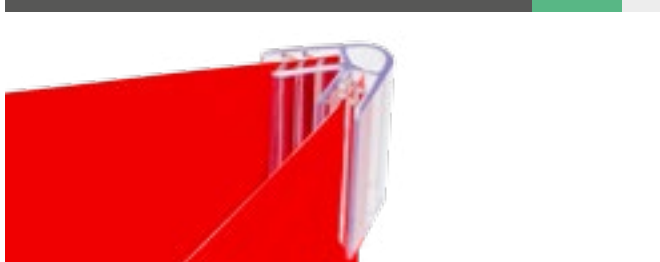

## GRIPPER DETAIL INFORMATION \*mm



This "L" transparent PVC gripper takes up to 2mm thickness cards with 90° angle connection. Ideal for joining cardboard displays, mobiles construction or for displaying signage at POS.

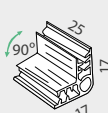

L90 GRIPPER	SIZE		
12.198	17x17x25mm	x100	

## "L" 90° GRIPPER



## GRIPPER DETAIL INFORMATION \*mm



This "Y" transparent PVC gripper takes up to 2mm thickness cards with a 3 ways connection. Ideal for joining cardboard displays, mobiles construction or for displaying signage at POS.

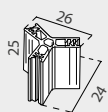

Y GRIPPER	SIZE		
12.372	26x24x25mm	x100	

## "Y" GRIPPER



## GRIPPER DETAIL INFORMATION \*mm



This "X" transparent PVC gripper takes up to 2mm thickness cards with a 4 ways connection. Ideal for joining cardboard displays, mobiles construction or for displaying signage at POS.

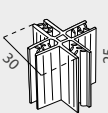

X GRIPPER	SIZE		
12.199	30x30x25mm	x100	

## "X" GRIPPER



## CONNECTOR DETAILS

## INFORMATION

\*mm

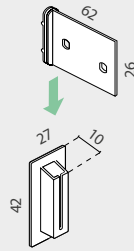

Two interlocking connector pieces for bonding into corrugated cardboard, which are designed for a solid and great supporting on shelf. Also allows an easy flat pack distribution. Ideal for the construction of cardboard displays.

C-27x42x62 PLATE SIZE BASE SIZE

12.517 62x26mm 27x42mm x100 

## CARDBOARD CONNECTOR 62x26mm PLATE



## CONNECTOR DETAILS

## INFORMATION

\*mm

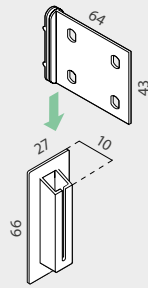

Two interlocking connector pieces for bonding into corrugated cardboard, which are designed and great supporting on shelf. Also allows an easy flat pack distribution.

C-27x66x64 PLATE SIZE BASE SIZE

12.516 64x43mm 27x66mm x100 

## CARDBOARD CONNECTOR 64x43mm PLATE



## CONNECTOR DETAILS

## INFORMATION

\*mm

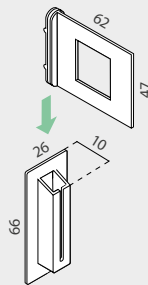



Two interlocking connector pieces for bonding into corrugated cardboard, which are designed and great supporting on shelf. Also allows an easy flat pack distribution.

C-26x66x62 PLATE SIZE BASE SIZE

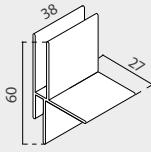

12.515 62x47mm 26x66mm x100 

## CARDBOARD CONNECTOR 62x47mm PLATE



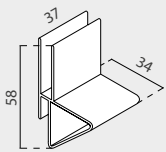

CLIP DETAIL	INFORMATION	DIMENSIONS	*mm
	Transparent PVC clip for quick and secure corrugated shelf construction by slotting into die cut holes.		
BRACKET	SIZE		
12.514	38x60x27mm	x100 	



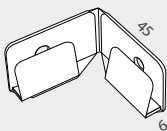

CLIP DETAIL	INFORMATION	DIMENSIONS	*mm
	Transparent and reinforced clip for quick and secure, high strength corrugated shelf construction by slotting into die cut holes.		
REINFORCED	SIZE		
12.513	37x58x34mm	x100 	



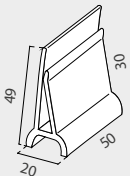

CASTER DETAIL	INFORMATION	DIMENSIONS	*mm
	Caster rises the cardboard display to avoid the contact with the ground and also enables easy moving of the cardboard display. Fast assembly with clip on bottom of cardboard display.		
SIMPLE	CORNER LENGTH		
12.286	45x45mm	x100 	



CASTER DETAIL	INFORMATION	DIMENSIONS	*mm
	This caster feet rises display from ground extending the life of usage. It enables easy moving of cardboard display. Easy assembly with clip on bottom of cardboard display.		
CLIP	HEIGHT		
12.518	49mm	x100 	

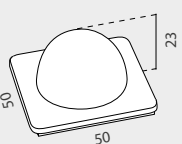

CASTER DETAIL	INFORMATION	DIMENSIONS	*mm
	This caster rises the cardboard display 23mm from the ground and protects it from damaging, featuring a 50x50mm adhesive foam. It also enables easy moving of display. Fast assembly.		
ADHESIVE	SIZE		
12.287	50x50x23mm	x100 	



# CARDBOARD ACCESSORIES Rivets | Screws

## INFORMATION

We provide an excellent selection of fasteners, such as plastic bolts, nuts or screws for the signage attachment and other applications.

Plastic rivet fasteners have numerous applications and come in a wide variety of styles, sizes, and configurations to accommodate different panel dimensions.

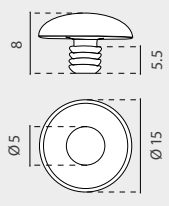
push



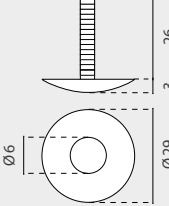

12.283    Ø 15 | Ø 5mm    5.5mm    x100 

push



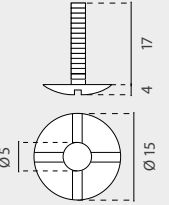

12.285    Ø 29 | Ø 6mm    26mm    x100 

screw



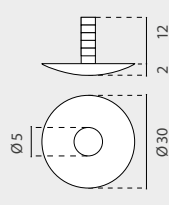

12.367    Ø 15 | Ø 5mm    17mm    x100 

push



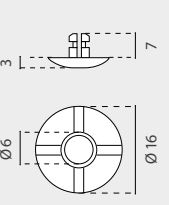

12.114    Ø 30 | Ø 5mm    12mm    x100 

push



12.469    Ø 16 | Ø 6mm    7mm    x100 

push

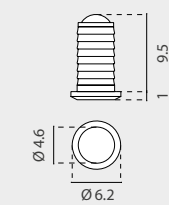

50.111    Ø 6.2 | Ø 4.6mm    9.5mm    x100 



# CARDBOARD ACCESSORIES Rivets | Screws





screw 



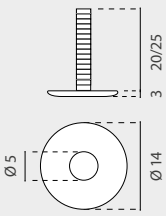

12.466	Ø 15   Ø 5mm	8mm	x100 
12.467	Ø 15   Ø 5mm	15mm	x100 
12.468	Ø 15   Ø 5mm	20mm	x100 





screw 



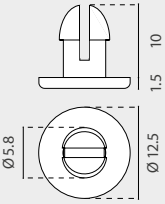

12.463	Ø 14   Ø 5mm	20mm	x100 
12.464	Ø 14   Ø 5mm	25mm	x100 





push 



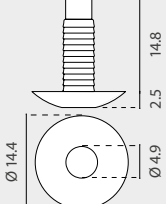

12.521	Ø 12.5   Ø 5.8mm	10mm	x100 
--------	------------------	------	--





push 



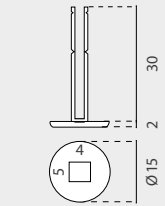

50.110	Ø 14.4   Ø 4.9mm	14.8mm	x100 
--------	------------------	--------	--







push 

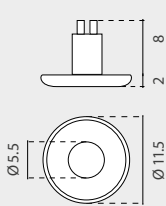



12.532	Ø 15   6x5mm	30/12mm	x100 
--------	--------------	---------	--





push 



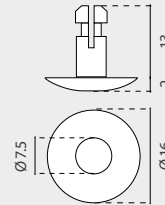

12.533	Ø 11.5   Ø 5.5mm	10mm	x100 
--------	------------------	------	--





push 



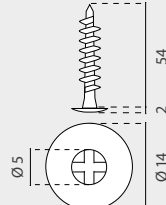

12.534	Ø 16   Ø 7.5mm	15mm	x100 
--------	----------------	------	--





screw 



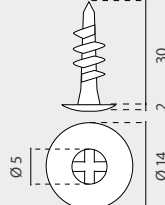

12.535	Ø 14   Ø 5mm	56mm	x100 
--------	--------------	------	--





screw 

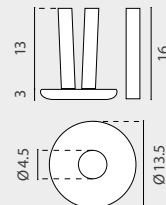

12.536	Ø 14   Ø 5mm	32mm	x100 
--------	--------------	------	--

push 



12.537	Ø 13.5   Ø 4.5mm	16mm	x100 
--------	------------------	------	--

# SHELF SIGNAGE Shelf Signage Holder

## CURVED STOPPER CLIP HOLDER



### DIMENSIONS \*mm

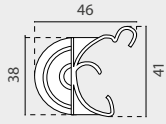

### INFORMATION

This Curved Clip is ideal for attaching cards and being used as a promotion Stopper on shelving.

CURVED	SIZE	
12.474	41x46mm	x100 

## STRAIGHT STOPPER CLIP HOLDER



### DIMENSIONS \*mm

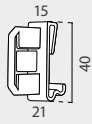

### INFORMATION

This Straight Clip is ideal for attaching cards and being used as a promotion Stopper on shelving.

STRAIGHT	SIZE	
12.071	40x15mm	x100 

## CLIP 39mm DATA STRIP



### DIMENSIONS \*mm

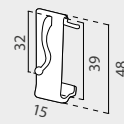

### INFORMATION

This Data Strip Clip with hook is ideal for being used on 39mm shelf profiles at point of sale.

CLIP 39	SIZE	
12.451	15x48mm	x100 





## SHELF LABEL HOLDER



### INFORMATION \*mm

This Curved Clip features a hinged base for protecting signage against the shocks.



SHELF LABEL	SIZE	
12.414	78x152mm	x50 
12.417	78x203mm	x50 
12.419	106x152mm	x50 
12.421	106x203mm	x50 

## HANGING LABEL HOLDER



### INFORMATION \*mm

This white Label Holder features a 120x39mm card insert and 2 top plastic hook hangers. This label is ideal for promotion or as pricing holder for rods or wire baskets.

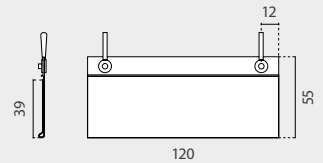

HANG LABEL	GRAPHIC SIZE	
12.295	120x39mm	x50 

## SHELF STRIP LABEL HOLDER

### HOLDER DETAILS DIMENSIONS \*mm

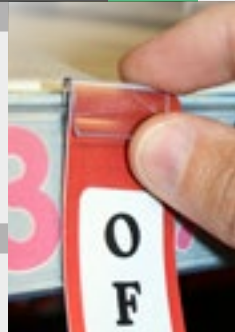
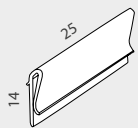

### INFORMATION

This holder can be used on most of the standard shelf profiles and it allows 1mm max. graphic thickness.

SHELF STRIP	SIZE	
12.458	14x25mm	x100 

## STOPPER SLEEVE HOLDER



### INFORMATION

This transparent Sleeve Holder is ideal for being used as a stopper support.

SLEEVE	SIZE	
12.527	215x112mm	x20 



# SHELF SIGNAGE Shelf Signage Holder

## ADHESIVE COUPON LABEL HOLDER



### INFORMATION

This coupon holder has a resistant back adhesive strip. 2 thicknesses available, 8mm for 75 coupons (115g paper) or 18mm for 125 coupons (115g paper). Ideal for promoting at supermarkets shelves.



ADHESIVE	THICKNESS		
12.212	8mm	x20	
12.214	18mm	x20	

## GRIPPER COUPON LABEL HOLDER



### INFORMATION

This coupon holder features a 75mm back gripper for attaching to the front of the shelves. 2 thickness: 8mm for 75 coupons (115g paper) or 18mm for 125 coupons (115g paper). Ideal for promoting at markets shelves.

GRIPPER	THICKNESS		
12.213	8mm	x20	
12.215	18mm	x20	

## FRONT CLIP LABEL HOLDER



### INFORMATION

This white snail clip is ideal for the communication on shelves, it has several applications thanks to its flexible long clip and its front adhesive. Ideal to compose long displays using more than one clip.

FRONT CLIP	SIZE		
12.232	30x70mm	x20	

## STOPPER BANNER



### INFORMATION

This transparent stopper for shelves has a straight holed 85mm arm holder with 4 spurs for attaching the graphics. Ideal for supermarkets shelves. Clip for attaching to shelf is not included.

STOPPER	HEIGHT		
12.222	85mm	x50	

## 3 POSITIONS STOPPER BANNER

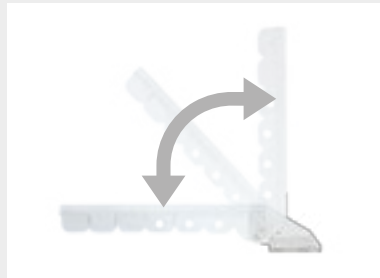

### INFORMATION

This transparent stopper for shelves has a 3 position arm holder with 6 spurs for attaching the graphics. Ideal for supermarkets shelves. Clip for attaching to shelf is not included.

3 POSITIONS	LENGTH		
12.223	145mm	x50	

## CLIP BANNER CONNECTOR



### INFORMATION

This clip connector is suitable for being used with Stopper Banner (12.222) and 3 Position Stopper Banner (12.223) in 54mm spaced holes perforated shelves. It connects the stopper to the shelf.

CLIP	LENGTH		
12.224	18mm	x100	

## TRANSPARENT WOBBLER

### INFORMATION

\*mm



This transparent wobbler has 2 adhesive foampads. Swinging effect for making points of sale promotions.

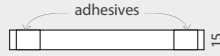

TRANSPARENT	LENGTH		
12.203	150mm	x200 	
12.225	200mm	x200 	

## ALUMINIUM WOBBLER

### INFORMATION

\*mm



It is made of aluminium, with 2 adhesive foampads. Ideal for highlight any kind of messages from the shelf.

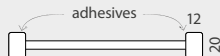

ALUMINIUM	LENGTH		
12.204	75mm	x100 	
12.205	150mm	x100 	

## "ROUND" ALUMINIUM WOBBLER

### INFORMATION

\*mm



This aluminium wobbler has 2 adhesive rounded foampads. Perfect for highlight any kind of messages from the shelf.

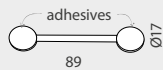

ROUND	LENGTH		
12.294	89mm	x100 	

## SPRING WOBBLER

### INFORMATION

\*mm



This wobbler has 2 square adhesive foam pads and a spring in the middle for giving movement to signage. Ideal for highlight messages with swinging effect.

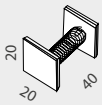

SPRING	SIZE		
12.206	20x20x40mm	x100 	

## SPACER WOBBLER

### INFORMATION

\*mm



The spacer wobbler adds an extra spacing effect. Also, it has 2 adhesive foampads. Excellent to enhance points of sale and fitting into any kind of support.



SPACER	SIZE		
12.207	13x26x17mm	x100 	

## WOBBLERS



## MAGNETIC CORNER BASE



### BASE DETAILS



### INFORMATION

\*mm

This system of magnetic profile for shelves is composed by a corner base (2 colors available) and a not included guide or gripper (available) where the graphics or promotion cards are inserted. This versatile system is ideal to create promotions on shelves at supermarkets.

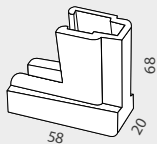

CORNER BASE	COLOR	WIDTH		
12.220		58mm	x20	
12.221		58mm	x20	



## GRIPPER PROFILE FOR MAGNETIC CORNER BASE

### PROFILE DETAILS



### INFORMATION

This Profile is suitable for use with the Magnetic Corner Bases (12.220 - 12.221).

GUIDE PROFILE	LENGTH	MAX.GRAPHIC THICK		
12.218	300mm	5mm	x20	
12.219	460mm	5mm	x20	

### PROFILE DETAILS



### INFORMATION

This Profile is suitable for use with the Magnetic Corner Base (12.220 - 12.221).

GRIPPER PROFILE	LENGTH	MAX.GRAPHIC THICK		
12.216	300mm	3mm	x20	
12.217	460mm	3mm	x20	

## MAGNETIC CLIP



### CLIP DETAIL



### INFORMATION

\*mm

This magnetic base has a hinged clip which allows a max. graphic thickness of 8mm.

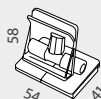

MAGNETIC CLIP	SIZE		
12.078	54x58x41mm	x50	

## ADHESIVE CLIP



### CLIP DETAIL

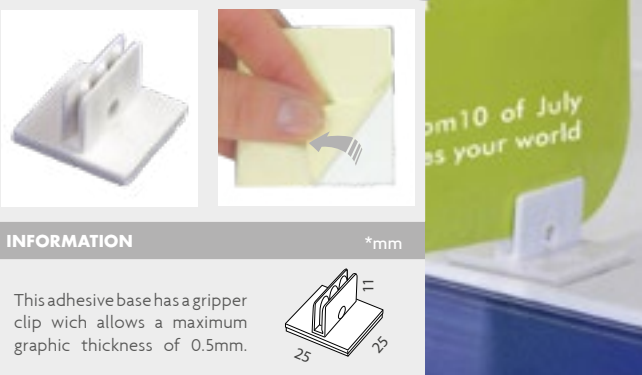

### INFORMATION

\*mm

This adhesive base has a gripper clip which allows a maximum graphic thickness of 0.5mm.

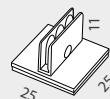

ADHESIVE CLIP	SIZE		
12.134	25x25mm	x100	

HOLDER DETAILS



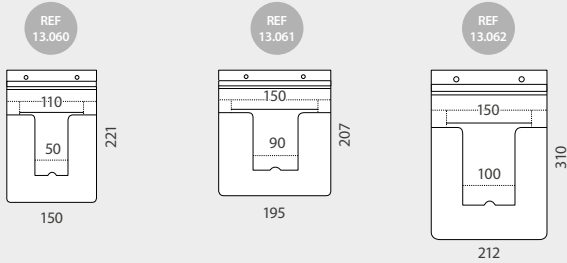

DIMENSIONS

\*mm



INFORMATION

This dispensers are made of 0.5mm thickness PVC. Suitable for A5 or A6 documents (from 110 to 150mm maximum width documents). They are excellent for fixing on shelf edges thank to its top adhesive strip.

DISPENSER	DOCUMENT	SIZE	THICKNESS		
13.060	A6	150x221mm	0.5mm	x30	
13.061	A5-A6	195x207mm	0.5mm	x30	
13.062	A5	212x310mm	0.5mm	x30	

BROCHURE PVC HOLDER

PVC



HOLDER DETAILS

INFORMATION

\*mm



This dispenser, made of PVC with adhesive strip, is excellent for holding business cards or promotional coupons. Container external size: 110x60x30mm.

DISPENSER	SIZE	THICKNESS	
13.431	110x60x30mm	0.4mm	x30 

COUPON CARD PVC HOLDER

PVC



## STAND DETAILS

\*mm

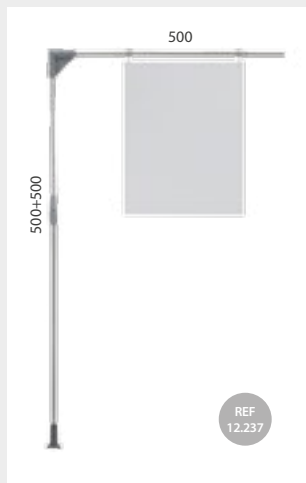
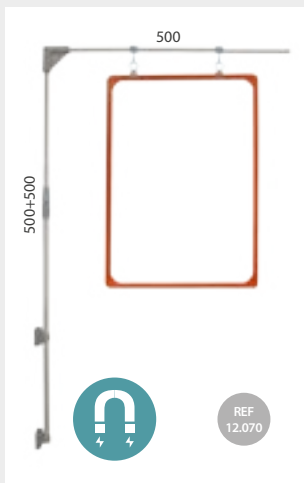

### INFORMATION

It Includes a Telescopic pole + 500mm Upper Arm + 2 Magnetic holders. Frame kit not included. Suitable with any metallic furniture. Ideal for displaying at markets.

### INFORMATION

It includes a Telescopic (500+500) pole + 500mm Upper Arm + Screw-in support base. Graphic holder not included. Ideal for being placed close to products at supermarkets.

L STAND	LENGTH	*mm	
12.070	Pole: 500+500 Upper Arm: 500	x20	
L STAND	LENGTH	*mm	
12.237	Pole: 500+500 Upper Arm: 500	x20	

## EXTENDABLE "L" STAND



## STAND DETAILS

\*mm

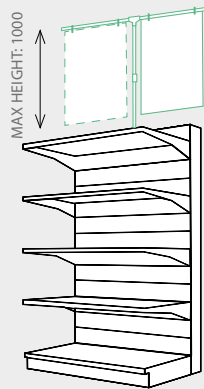
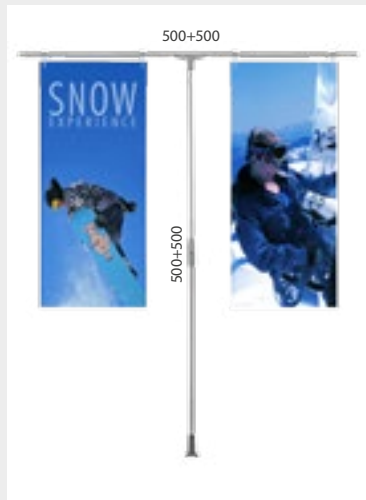

Ideal for being placed up supermarket gondolas.

### INFORMATION

"T" Stands includes a Telescopic Pole (1000mm max. height) + Screw-in support + "T" Clamp + Upper Arms + Hooks. Ideal for displaying sales at supermarkets.

EXT. STAND	LENGTH	*mm	
12.075	Pole: 500+500 Upper Arms: 500+500	x20	

## EXTENDABLE "T" STAND



# SHELF SIGNAGE Shelf Extendable Banners

Various graphic displays for gondola or shelf-systems.

They are ideal to for holding signage at point of sales



## INFORMATION

Telescopic tube (600mm max.) for Slatwalls. With 2 plastic hooks for holding signage.

SLATWALL	LENGTH	
12.072	Tube: 300+300mm	x10 

## EXTENDABLE BANNER FOR SLATWALL



## INFORMATION

Telescopic tube (600mm max.) for Pegboard. With 2 plastic hooks for holding signage.



UPRIGHT	LENGTH	
12.073	Tube: 300+300mm	x10 

## EXTENDABLE BANNER FOR PEGBOARD



## INFORMATION

Telescopic tube with 2 plastic hooks and 2 magnetic bases for metallic surfaces. This support for shelving features 3 lengths available (600, 800 or 1000mm).

MAGNET	LENGTH	
12.181	Tube: 300+300mm	x10 
12.231	Tube: 400+400mm	x10 
12.300	Tube: 500+500mm	x10 

## MAGNET EXTENDABLE BANNER



## HOOK DETAIL

## INFORMATION

\*mm



This transparent plastic hook is perfect for using with Extendable "L" or "T" Stands or Extendable Banners. Ideal for being used at supermarkets

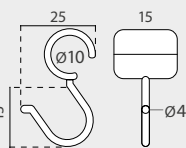

## POLE HOOK

12.076	x20 
--------	---

## POLE HOOK





# SHELF SIGNAGE Shelf Magnet Banners

Magnetic holder system suitable for metallic shelves.



## INFORMATION

This magnetic shelf holder system features multiple solutions to the implementation of graphic promotions to metal shelves. The base is made of ABS with a magnet inside, it sizes 40x70mm, also it can be rotated to adjust exposure to optimal angle. To adjust the pole angle to the desired exposure, simply detach the base slightly from the angle bracket **2**, adjust the pipe to the proper angle **3**, and return the base to its original position so that it is secure **4**. The aluminum pole offers the possibility of approaching the promotion to the passerby and has several options to hang different sizes of graphics, including transparent movable hooks, transparent movable clips or grippers for attaching posters or promotions. Either to be used on or below the shelf, several models are available to meet your needs. This multi-position holder system is often used on metallic shelves, poles or walls, so it is widely used in shopping malls specially in shopping center, supermarket aisles or pharmacies.

## POLE ANGLE ADJUSTMENT

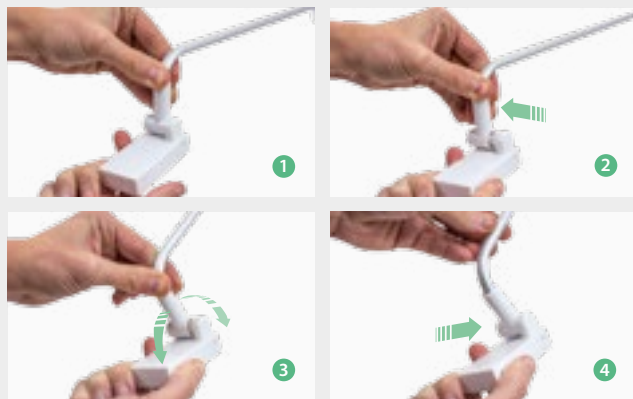

# SHELF SIGNAGE Shelf Magnet Banners

## HOLDER DETAILS



## INFORMATION

\*mm

This multi-position promotion holder features 1 transparent gripper for attaching graphics and a curved pole which is ideal for being used on walls, poles or onto-beneath the shelves.

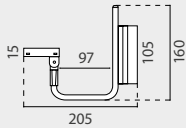

GRIPPER

12.511

x2 

## GRIPPER MAGNET BANNER



## HOLDER DETAILS



## INFORMATION

\*mm

This multi-position holder system features 2 transparent clamps and an angled pole which is ideal to get an extra separation from the product.

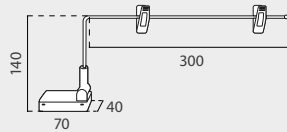

ANGLED

12.302

x10 

## ANGLED MAGNET BANNER

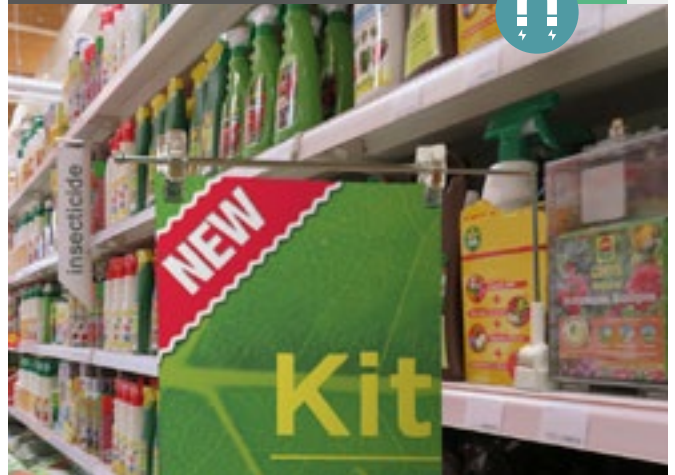

## HOLDER DETAILS



## INFORMATION

\*mm

This multi-position holder features 2 transparent clamps and a straight pole which is ideal for occupying as little space as possible on the shelf.

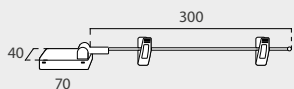

STRAIGHT

12.303

x10 

## STRAIGHT MAGNET BANNER



# SHELF SIGNAGE Shelf Magnet Banners

## HOLDER DETAILS



## INFORMATION

\*mm

This multi-position holder features 2 transparent hooks and a curved 400mm pole which is ideal for being used onto or beneath the shelves.

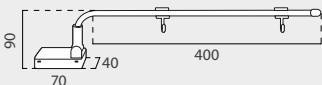

400 HOOK

12.381

x10 

## CURVED 400 MAGNET BANNER

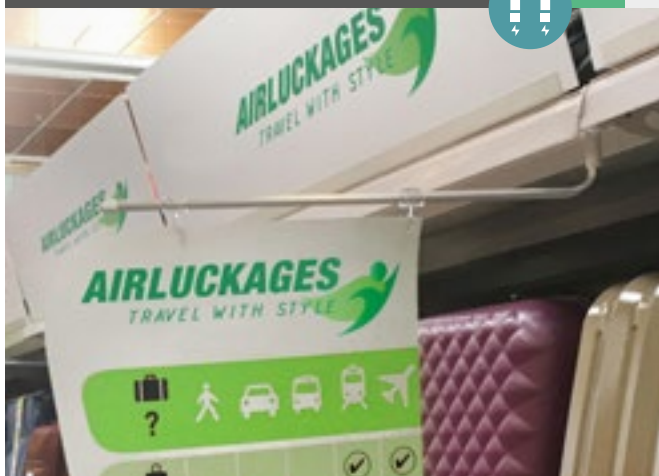

## HOLDER DETAILS



## INFORMATION

\*mm

This multi-position holder features 2 transparent hooks and a 300mm curved pole which is ideal for being used onto or beneath the shelves.

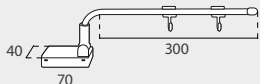

300 HOOK

12.555

x10 

## CURVED 300 MAGNET BANNER

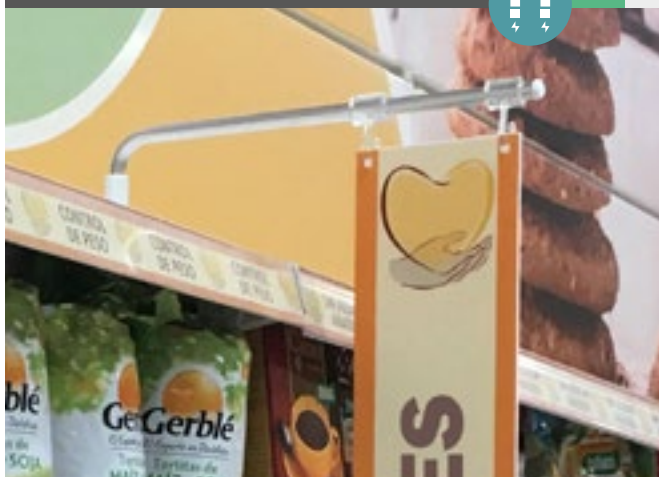

## HOLDER DETAILS



## INFORMATION

\*mm

This multi-position holder features 2 transparent hooks and a 200mm curved pole which is ideal for being used onto or beneath the shelves.

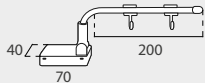

200 HOOK

12.557

x10 

## CURVED 200 MAGNET BANNER



# SHELF SIGNAGE Shelf Adhesive Banner

## MINI FLAG 300 POLE

### POLE DETAILS



REF 12.174



REF 12.175



REF 12.176



### INFORMATION

300mm white flag pole with adhesive removable base. Available on 3 angles for displaying.

MINI FLAG	ANGLE	LENGTH		
12.174	60°	300mm	x50	
12.175	90° wall	300mm	x50	
12.176	180° shelf	300mm	x50	

## MINI FLAG 300 POLE WITH RING CLIPS

### POLE DETAILS



REF 12.177



REF 12.178



REF 12.179



### INFORMATION

300mm flag pole with adhesive removable base and clips for hanging graphics. 3 angles.

MINI RING FLAG	ANGLE	LENGTH		
12.177	60°	300mm	x50	
12.178	90° wall	300mm	x50	
12.179	180° shelf	300mm	x50	

## 60° FLAG POLE



### INFORMATION

60° flag pole with adhesive 115x50mm base. Flag can be inserted into the slot ①. 3 lengths.

60° FLAG POLE	ANGLE	POLE DIAMETER	LENGTH		
12.297	60°	∅ 18mm	280mm	x20	
12.299	60°	∅ 18mm	400mm	x20	
12.289	60°	∅ 18mm	600mm	x20	

## 90° FLAG POLE



### INFORMATION

90° flag pole with adhesive 115x50mm base. Flag can be inserted into the slot ①. 3 lengths.

90° FLAG POLE	ANGLE	POLE DIAMETER	LENGTH		
12.298	90°	∅ 18mm	280mm	x20	
12.288	90°	∅ 18mm	400mm	x20	
12.290	90°	∅ 18mm	600mm	x20	

## 300 FLAG BANNER MAGNET SUPPORT

### SUPPORT DETAIL



### INFORMATION

300mm flag pole with reinforced magnetic base. Ideal for shelving at supermarkets.

MAG. BANNER	LENGTH		
12.173	300mm	x10	

## 300 FLAG BANNER ADHESIVE SUPPORT

### SUPPORT DETAIL



### INFORMATION

300mm flag pole with double adhesive pads base. Ideal for shelving at supermarkets.

ADH. BANNER	LENGTH		
12.180	300mm	x20	

## SUPPORT DETAILS



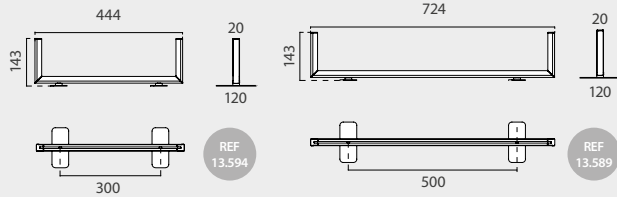

## DIMENSIONS

\* mm



## INFORMATION

This open white painted aluminium frame support features an easy glide for the graphic poster (5mm max. thickness). Also, it features 2 magnetic supports at the bases. Ideal for promoting on shelves at malls or at the supermarkets.

OPEN M.S.444	QTY	N.W	G.W	C.B.M	SIZE
Packing	2	0.94kg	1.08kg	0.0026	480x180x30mm
<b>13.594</b>	Graphic Width: 420mm		x2 		
OPEN M.S.724	QTY	N.W	G.W	C.B.M	SIZE
Packing	2	1.12kg	1.27kg	0.0041	760x180x30mm
<b>13.589</b>	Graphic Width: 700mm		x2 		

## OPEN ALUMINIUM MAGNET SUPPORT



## DISPLAY DETAILS



## DIMENSIONS

\* mm

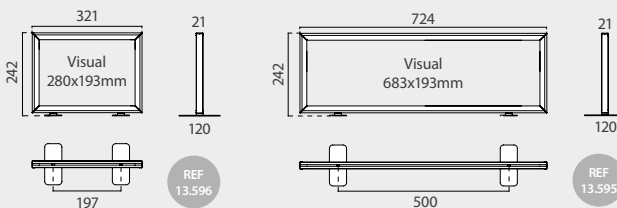

## INFORMATION

This closed silver aluminium frame support features an easy glide for the graphic poster (5mm max. thickness). Also, it features 2 magnetic supports at the bases. Ideal for promoting on shelves at malls or at the supermarkets.

CLOSED M.S.321	QTY	N.W	G.W	C.B.M	SIZE
Packing	2	1.5kg	1.61kg	0.0046	335x250x55mm
<b>13.596</b>	Graphic Size: 298x220x5mm		x2 		
CLOSED M.S.724	QTY	N.W	G.W	C.B.M	SIZE
Packing	1	0.88kg	1kg	0.0055	735x250x30mm
<b>13.595</b>	Graphic Size: 700x220x5mm		x2 		

## CLOSED ALUMINIUM MAGNET SUPPORT



# SHELF SIGNAGE Clip Strip

## STRIPS DETAILS



### DIMENSIONS \*mm



STRIP 780	HEIGHT	THICK	
12.525	780mm	2mm	x50 



## STRIPS DETAILS



### DIMENSIONS \*mm



STRIP 663mm	HEIGHT	THICK	
12.228	663mm	0.8mm	x50 

## CLIP STRIP

**new**



## STRIPS DETAILS



### DIMENSIONS \*mm



STRIP 620	HEIGHT	THICK	
12.526	620mm	1.13mm	x50 



## STRIPS DETAILS



### DIMENSIONS \*mm

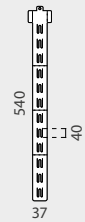

STRIP 540mm	HEIGHT	THICK	
12.229	540mm	0.5mm	x50 

**new**



## HOOK DETAILS



### INFORMATION \*mm

This 38 length double hook is made of metal and it is ideal for being used with the plastic clip strips thanks its bottom hook design which prevents the merchandising strip from falling.





STRIP HOOK	LENGTH	
12.157	38mm	x100 

## STRIPS DETAILS

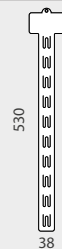

### DIMENSIONS \*mm



STRIP 530mm	HEIGHT	THICK	
12.227	530mm	0.5mm	x50 

**new**



# COATING 13

Complete range of coating accessories which provide an integral solution for professional of printing presses, sign making business or design studios.

- 554** SQUEEGEES
- 556** CUTTING ACCESSORIES
- 558** MEASUREMENT
- 561** SIGNMAKING ACCESSORIES
- 564** FASTENING | TRANSPORT
- 566** MAGNET SERIES
- 568** EYELET MACHINE
- 569** BADGE MACHINE
- 570** HEAT GUNS



## SQUEEGEES



### INFORMATION

\*mm

This rectangular squeegee is made of 100% wool. Thanks to its dimension is ideal for the application of vinyl.



16.012 100x70x13mm x10  



### INFORMATION

\*mm

This "half moon" squeegee is made of 100% wool. Thanks to its shape is ideal for the application of vinyl.

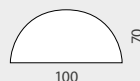

16.014 100x70x13mm x10  



### INFORMATION

\*mm

This squeegee has been designed for an ergonomic use. Blue colored. It is ideal for the application of vinyl.



16.096 100x70mm x10 



### INFORMATION

\*mm

This white squeegee has been designed for an ergonomic use and the application of vinyl.



16.003 100x70mm x10 

16.004 130x70mm x10 

## PLASTIC-RUBBER SQUEEGEE



### INFORMATION

\*mm

This squeegee features a plastic blue colored handle and a white "V" shaped with land rubber profile with flat tip. It is ideal for the application of vinyl.



16.097 123x82x30mm x10 

## WOOD-RUBBER SQUEEGEE



### INFORMATION

\*mm

This squeegee features a wood handle. "V" shaped and blue colored rubber profile with sharp tip. It is ideal for the application of vinyl.

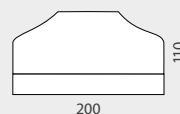

16.099 200x110x44mm x5 



# SQUEEGEES Squeegees

## XL SQUEEGEE



### INFORMATION

\*mm

This squeegee is made of yellow colored plastic. Thanks to its size is ideal for several applications, such as car styling decal, vinyl film, stickers, covers scrape...

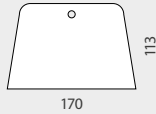

16.098

170x113mm

x10

## XXL SQUEEGEE



### INFORMATION

\*mm

This big squeegee is made of blue colored plastic. Thanks to its ergonomic plastic handle is ideal for the application of car styling decals, vinyl films, stickers or covers scrape.

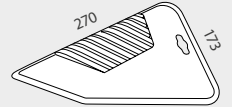

16.101

270x173mm

x5

## 240mm SQUEEGEE ERGONOMIC PAD



### INFORMATION

\*mm

This squeegee is made of plastic. Thanks to its ergonomic plastic pad is ideal for the application of car styling decals, vinyl films, stickers or covers scrape.

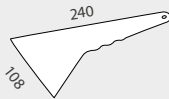

16.000

108x240mm

x10

## 135mm SQUEEGEE ERGONOMIC PAD



### INFORMATION

\*mm

This squeegee is made of plastic. Thanks to its ergonomic plastic pad is ideal for the application of car styling decals, vinyl films, stickers or covers scrape.

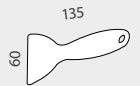

16.001

60x135mm

x10

## 115mm SQUEEGEE PAD



### INFORMATION

\*mm

This squeegee is made of plastic. Thanks to its dimensions and to its pad is ideal for the application of vinyl in small places.



16.002

90x115mm

x10

## PRECISION SQUEEGEE



### INFORMATION

\*mm

This squeegee is made of plastic. Thanks to its reduced size is ideal for the application of vinyl in small places

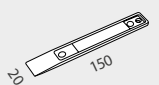

16.006

20x150mm

x10

# CUTTING ACCESSORIES Cutting Accessories

## PRECISION 9mm CUTTER



### INFORMATION

\*mm

This slimline metallic cutter is ideal for cutting vinyl, tint or paper... Its 9mm steel blade features an optimum sharpness for an improved precision.

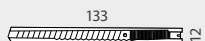

16.063

x5

## STANDARD 9mm CUTTER



### INFORMATION

\*mm

This popular cutter has a 9mm high carbon tool steel blade for an optimum sharpness. Blade snapper and clip for pockets are included.

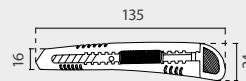

16.140

x20

## PRO TOUCH 9mm CUTTER



non slip design

### INFORMATION

\*mm

This Pro-Touch cutter has a 9mm high carbon tool steel blade and features an ergonomic rubber handle. Blade snapper is included.

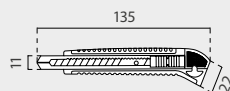

16.143

x5

## HEAVY-DUTY 18mm LARGE CUTTER



non slip design

### INFORMATION

\*mm

This cutter has a 18mm high carbon tool steel blade and features an ergonomic rubber handle. With a hole for lanyards.

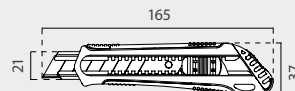

16.142

x5

## RETRACTABLE 18mm PROFESSIONAL CUTTER



non slip design

autoretractable blade, holding down the button

### INFORMATION

\*mm

Professional cutter has a 18mm high carbon tool steel autoretractable blade and also, it features autolock system. With an ergonomic rubber handle and hole for the lanyards.

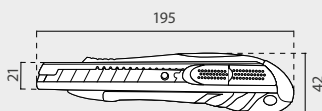

16.141

x5



## MINI SMALL CUTTER



### INFORMATION

\*mm

This small cutter is ideal for trimming vinyl, tint or paper. Its special design is ideal for an improved precision with long continuous cuts.

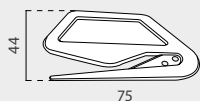

16.103      75x44x3mm      x20

## SNAPPY SAFE CUTTER



### INFORMATION

The Snappy Cutter features a blade adjustment with safety lock system. Its special design is ideal for an improved precision with curved cuts.



16.007      x10



adjustable blade

### INFORMATION

\*mm

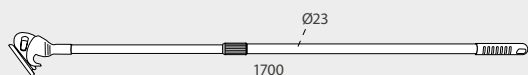

The Telescopic Cutter features a blade adjustment with safety lock system. Its adjustable length tube is ideal for an improved precision in height cuts.

16.104      Ø23x1700mm

## TELESCOPIC CUTTER

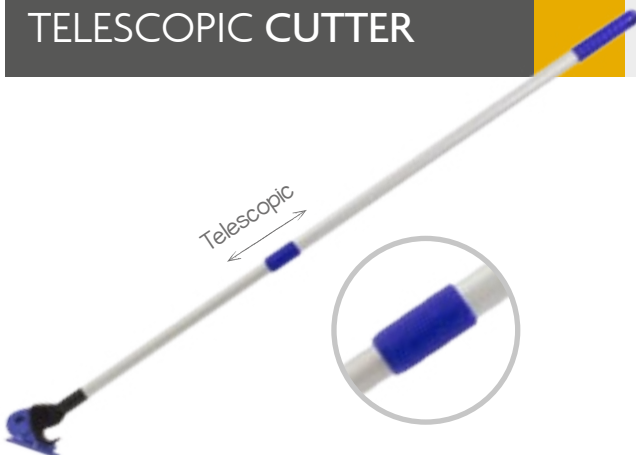

## CUTTING MAT



### INFORMATION

This mat is ideal for precision cutting. It features 5 dimensions available.

16.061	A5
16.062	A4
16.066	A3



16.067	A2
16.068	A1

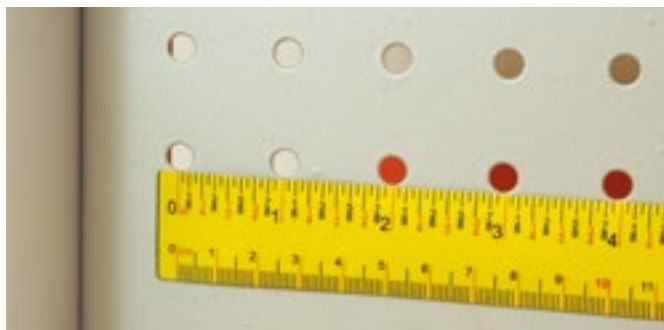

### INFORMATION

This Magnetic Measuring Ruler provides a convenient solution for determining approximate distances without using the hands on an optical table or breadboard. With a magnetic back that extends throughout the meter area, this measuring tape lays flat on any magnetic surface and features both imperial and metric scales.

16.122

Length: 1000mm/36"



## MAGNETIC RULER



### INFORMATION

This Magnetic Ruler provides a convenient solution for determining approximate distances without using the hands. With a magnetic back that extends throughout the meter area, this measuring tape lays flat on any magnetic surface.

16.123

Length: 1000mm



## MAGNETIC RULER



### INFORMATION

This rule provides a safe and convenient solution for precision cutting work. Featuring 3 lengths of Safety Cutting Ruler (1000mm, 1500mm and 2500mm).



## SAFETY CUTTING RULER



16.030

Length: 1000mm

16.031

Length: 1500mm

16.032

Length: 2500mm

# MEASUREMENT Measure Tapes



stop locking system



## ABS 5m 25mm TAPE MEASURE



5m tape  
25mm blade

### INFORMATION

This ultra durable ABS pocket tape measure features a 5m tape with a 25mm wide blade. Featuring a strong blade locking system, belt clip and wrist strap.

16.144    Length: 5000mm    Width Blade: 25mm    x5



suitable for  
metallic surfaces

## MAGNETIC 5m 25mm TAPE MEASURE



stop locking system



magnetic extreme

### INFORMATION

This Professional ultra durable tape measure is highly resistant thanks to its anti-shock ABS plastic case and comfortable thanks to its soft grip rubber outer. It features a 5m tape with a 25mm wide blade. Featuring a magnetic end hook, which connects securely to metals (shelves, beading, pipework, etc) but can be easily removed from the surface. Also it has One-Stop lock system, belt clip and wrist nylon strap.

16.146    Length: 5000mm    Width Blade: 25mm    x5



### INFORMATION

This ultra durable ABS tape measure features a 30m or 50m tape. A folding handle with rotating knob makes an easy rewinding. With wrist nylon strap

16.070    Length: 30000mm    x5

16.071    Length: 50000mm    x5

## MEASURING TAPE



## HAND CALIPER

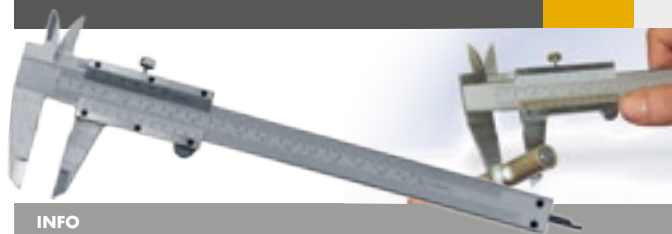

### INFO

Calipers can be used to measure internal and external dimensions with utmost precision.

16.058 From 0 to 150mm

## DIGITAL CALIPER



### INFO

Digital measure (mm to inches). Zero button which sets any reference point to zero.

16.057 From 0 to 150mm

### INFORMATION

Battery-operated digital High Precision Pocket Scales. With easy-to-read LCD.



16.055 Weight capacity: 0.1 - 500g

## HIGH PRECISION POCKET SCALE

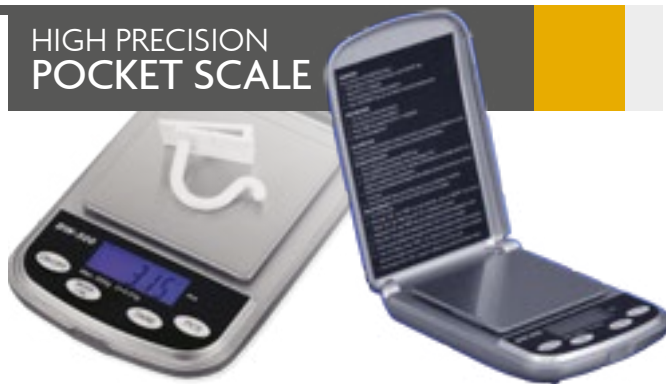

16.056 Weight capacity: 0.01 - 300g

## LINEN TESTER 33.3mm

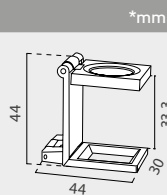

### INFORMATION

This line tester frame folds flat for an easy storage. Featuring 33mm height.

16.077 44x30x33.3mm

## LINEN TESTER 50mm

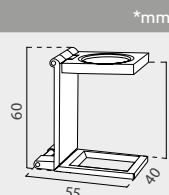

### INFORMATION

This line tester frame folds flat for an easy storage. Featuring 50mm height.

16.078 55x40x50mm



### INFORMATION

This High Quality Line Tester is preferred for professional usage. Transport pocket included. It is, also used for an extensive range of professions: graphic design, desktop publishing, film/dia/photo negatives and even in biology...

16.079 Ø25x53mm

## LINEN TESTER LUXE



transport pocket included

**new**

## STORAGE DETAIL

## DIMENSIONS

\*mm

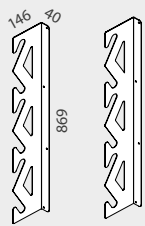

pack of 2 metal sheets

## INFORMATION

This black colored metallic holders allows you to store vinyl or rolls of clothes. It is sold in packs of 2 units. Easy and fast mounting to the wall. It is ideal for being used at printing presses, sign makers, design studios or for tailor stores.

ROLL STORAGE	QTY	N.W	G.W	C.B.M	SIZE
Packing	1	3.97kg	4.26kg	0.0075	170x890x50mm
<b>13.849</b>		<b>146x869x40mm</b>		<b>x2</b>	

## WALL ROLL STORAGE



\* roll tube not included

## STORAGE DETAILS

16 roll capacity



## INFORMATION

\*mm

This metallic 500x500x400 mobile unit allows you to store 16 vinyl rolls. Allen key and 4 rotary brake wheels are included. Ideal for printing presses, sign makers, design studios or for tailor shops.

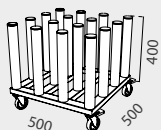

16.115	500x500x495	16 rolls capacity
--------	-------------	-------------------

## MOVIBLE ROLL STORAGE



brake wheels

\* vinyl rolls not included

## CLIP DETAILS



## INFORMATION

\*mm

Clip fastener for vinyl or rolls of clothes. It is made of purple colored plastic. Ø83mm or Ø110mm available. Ideal for printing presses, sign makers, design studios or for tailor shops.

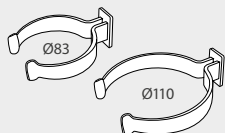

16.108	Ø83mm	x20
16.109	Ø110mm	x20

## SPEED CLIP SMALL



## BAG DETAIL



## INFORMATION

This black and red tool bag is made of nylon. It is ideal for being used with a tool belt. Featuring several tool pockets and various applications.

16.105

280x175mm

## TOOL BAG L

ideal for  
tool belts



## BAG DETAIL



## INFORMATION

This black and grey tool bag is made of nylon. It is ideal for being used as a tool belt. Featuring several tool pockets and various applications.

16.106

295x260mm

## TOOL BAG XL





### MAGNETIC WRIST HOLDER



#### INFORMATION

Magnetic wrist holder with genuine VELCRO® brand system. Ideal for attaching tools.

16.126



### CLEANING SWAB



#### INFORMATION

These Cleaning swabs are ideal for labelling to fix small imperfections.

16.008

x10



### MAGNETIC RING



#### INFORMATION

\*mm

This single magnetic Ø30mm ring with folding handle is ideal for holding vinyls while labelling.



16.124

Ø30mm



### MAGNETIC BASE

suitable for any metallic surface



#### INFORMATION

\*mm

This single Ø60mm magnetic ring thanks to its big diameter is ideal for holding vinyls while labelling.

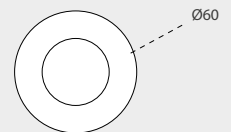

16.125

Ø60mm



## ELASTIC CORD

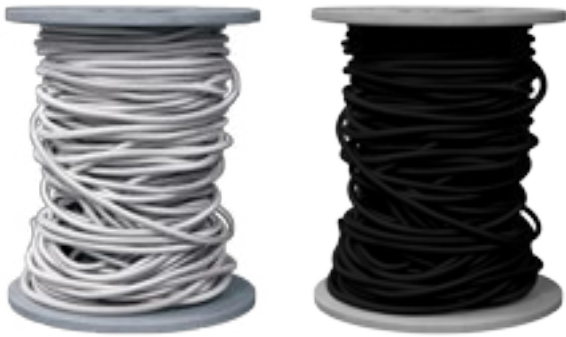

16.039		Ø6mm	
16.040		Ø6mm	

## CORNER GRIPS



easy clip-on

### INFORMATION

\*mm

- Made of nylon.
- It allows to hang the banner with corners, keeping it perfectly in tension.

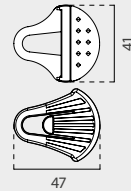

16.110	x40		
--------	-----	--	--

## FISHING NYLON ROLL

roll length: 500m



16.038	Ø0.5mm	Roll length: 500m	
--------	--------	-------------------	--

## NYLON LINE

roll length: 5m



12.373	Ø0.5mm	Roll length: 5m	x100
--------	--------	-----------------	------

velcro



### INFORMATION

Reusable genuine VELCRO® brand fasteners strap. Ideal for tying, holding or securing.

16.111	20x200mm	x50	
16.112	20x300mm	x50	
16.113	20x400mm	x50	

## ADJUSTABLE FIXING STRAP

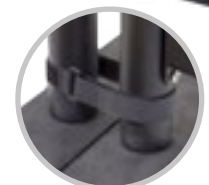
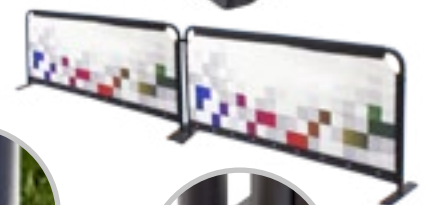

\* VELCRO® is a registered trademark of Velcro BVBA. | VELCRO® est une marque déposée de Velcro Industries B.V. | VELCRO® é uma marca registrada de Velcro Industries B. V. | VELCRO® es una marca registrada de VelcroIndustries B. V.

## CABLE TIES



### INFORMATION

These Cable Ties are ideal for being used as fastener for several uses, such as for primarily electrical cables, holding items together or wires. Black or transparent finish. 12 sizes available of cable ties.

16.043  
16.044

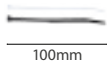

100mm

16.045  
16.046

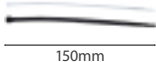

150mm

16.047  
16.048

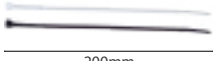

200mm

16.049  
16.050



250mm

16.051  
16.052

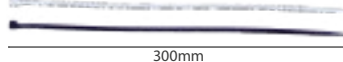

300mm

16.053  
16.054



400mm

16.043		2.5x100mm	x100
16.044		2.5x100mm	x100
16.045		3.6x150mm	x100
16.046		3.6x150mm	x100
16.047		4.8x200mm	x100
16.048		4.8x200mm	x100

16.049		4.8x250mm	x100
16.050		4.8x250mm	x100
16.051		4.8x300mm	x100
16.052		4.8x300mm	x100
16.053		7.2x400mm	x100
16.054		7.2x400mm	x100

## SUCTION CUPS

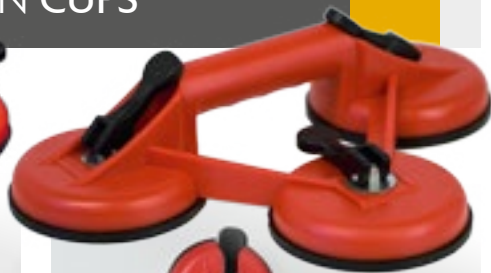

### INFORMATION

This single suction cup with folding handles is ideal for the transport of heavy panels up to 30kg weight.



### INFORMATION

Double suction cup for the transport of heavy panels up to 60kg weight.

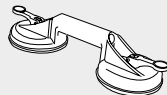

### INFORMATION

Double suction cup for the transport of heavy panels up to 120kg weight.



16.016 Capacity: 30kg

16.017 Capacity: 60kg

16.018 Capacity: 120kg

3 sizes available



\*mm



3  
Ø 8

16.080    Ø8x3mm    x50 



\*mm



3  
Ø 10

16.081    Ø10x3mm    x50 

## NEODYMIUM MAGNETIC INSERT DISCS



\*mm



5  
Ø 20

16.082    Ø20x5mm    x10 

\*mm

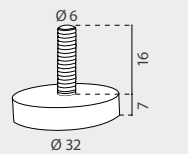

Ø 6  
16  
7  
Ø 32



16.084    Base: Ø32x7mm  
Screw: Ø6x16mm    x10 

## FERRITE MAGNETIC BASE

\*mm

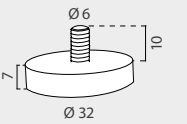

Ø 6  
10  
7  
Ø 32



16.083    Base: Ø32x7mm  
Screw: Ø6x10mm    x10 



\*mm

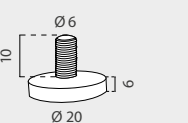

Ø 6  
10  
Ø 20



16.085    Base: Ø20x6mm  
Screw: Ø6x10mm    x10 

## NEODYMIUM MAGNETIC BASE

\*mm



Ø 6  
10  
7  
Ø 32



16.086    Base: Ø32x7mm  
Screw: Ø6x10mm    x10 

## MAGNETIC STRIP ROLL

**INFORMATION** \*mm

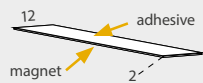

12 adhesive  
magnet 2

- 50m Roll.
- 2mm thickness strip.
- One adhesive side for fixing to the graphics.



	QTY	N.W	G.W	C.B.M	SIZE
Packing	1	3.4kg	3.82kg	0.0038	390x25x390mm
10.360	50m roll				

## MAGNETIC STRIP BY LINEAL METERS

\*mm



adhesive  
magnet 20 --- 1.2

16.087    Adhesive    Size: 20x1.2mm

\*mm





magnet 20 --- 1.2

16.088    Magnetic    Size: 20x1.2mm



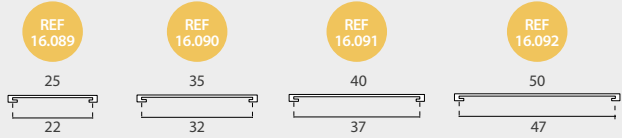

\*mm



16.089	Label width: 22mm	
16.090	Label width: 32mm	



## MAGNETIC DATA STRIP



16.091	Label width: 37mm	
16.092	Label width: 47mm	

\* Glasspack protector is not included



16.093	150x100x2mm	
16.094	950x400x2mm	

## MAGNETIC SHEET ANISOTROPIC

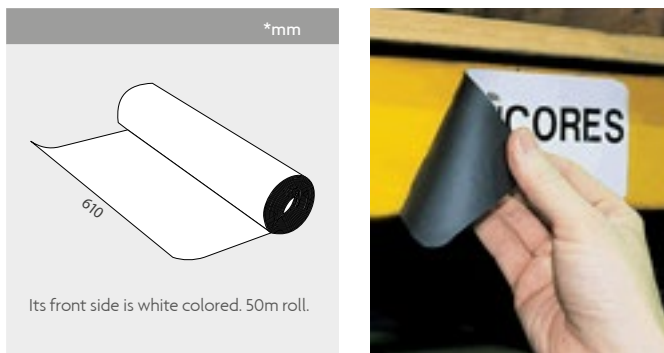



Its front side is white colored. 50m roll.

16.095	610x0.6mm	Roll length: 50m	
--------	-----------	------------------	---

## MAGNETIC ROLL ANISOTROPIC

50m roll



16.100	Diameter: Ø10mm	x120 	
--------	-----------------	--	---

## ANTI-SLIP PAD

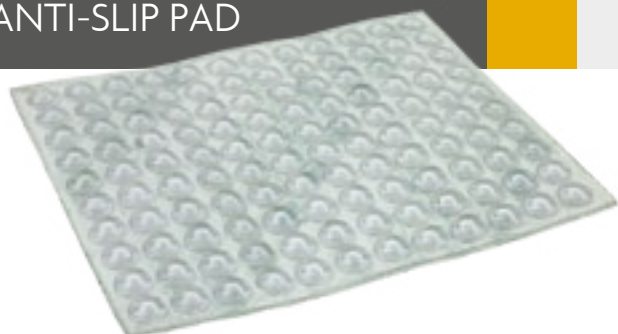

# EYELET MACHINE Eyelet Machine

## INFORMATION

This heavyweight professional hand operated press Eyelet Machine is designed to insert eyelet adapters (grommet die) from diameter from Ø6mm to Ø12mm. Changing adapters is simple (it includes 1 Allen key). It is a valuable addition to any workroom. It features holes at the base for fixing to any appropriate work surface. It is a valuable addition to any workroom. Its solid construction will give years of service in the workshop or out with the fitters.

## TABLE EYELET ADAPTERS



\*mm

For Ø6



REF 16.121

For Ø8



REF 16.020

For Ø10



REF 16.120

For Ø12



REF 16.021



16.121

Header diameter: Ø6mm



16.020

Header diameter: Ø8mm



16.120

Header diameter: Ø10mm



16.021

Header diameter: Ø12mm

## TABLE EYELET MACHINE



16.019

Header diameter: Ø10mm

## EYELETS

for table eyelet adapter



16.026



Ø6mm

x1000



16.022



Ø6mm

x1000



16.027



Ø8mm

x1000



16.023



Ø8mm

x1000



16.028



Ø10mm

x1000



16.024



Ø10mm

x1000



16.029



Ø12mm

x1000



16.025



Ø12mm

x1000



## BADGE MAKING MACHINE



includes mold



available in  
3 diameters



16.131 Diameter: Ø25mm

16.132 Diameter: Ø37mm

16.133 Diameter: Ø58mm

### METAL PIN BADGE



#### INFORMATION

These Metal Badges include base with pin + cap + protection cover. 3 diameters.

16.134 Diameter: Ø25mm x100 📦

16.135 Diameter: Ø37mm x100 📦

16.136 Diameter: Ø58mm x100 📦

### PLASTIC PIN BADGE



#### INFORMATION

These Plastic Badges include base with pin + cap + protection cover. 3 diameters.

16.137 Diameter: Ø25mm x100 📦

16.138 Diameter: Ø37mm x100 📦

16.139 Diameter: Ø58mm x100 📦

ideal for bending and welding plastic, softening adhesive, etc

## HEAT GUN



Voltage & Frequency:	230V - 50Hz
Rate power I/II:	1000/2000W
Temperature I/II:	350/550° C
Air Flow I/II:	300/500 l/min.
VDE plug:	2m cable

16.128



Voltage & Frequency:	230V - 50Hz
Rate power I/II:	2000W (Max)
Temperature I/II/III:	80/80-600/80-600° C
Air Flow I/II/III:	350/350/500 l/min.
VDE plug:	2m cable
Adjustable temperature	

16.129



Voltage & Frequency:	230V - 50Hz
Rate power I/II:	2000W (Max)
Temperature I/II/III:	50/70-600/70-600° C
Air Flow I/II/III:	300/300/500 l/min.
VDE plug:	2m cable
Display:	LCD
Adjustable temperature	

16.130





# SHOPFITTING 14

Wide range of panels, prongs, bars, shelving systems, priceholders, safety and parking accessories which provide an integral solution for stores at POS.

- 572** GRIDWALL
- 575** SLATWALL
- 582** PEGBOARD
- 586** BACK RAIL SYSTEM
- 590** PRONGS ACCESSORIES
- 596** LINE PROFILES
- 602** SHELF MANAGEMENT
- 609** STORE ACCESSORIES
- 624** PARKING | SAFETY SUPPLIES

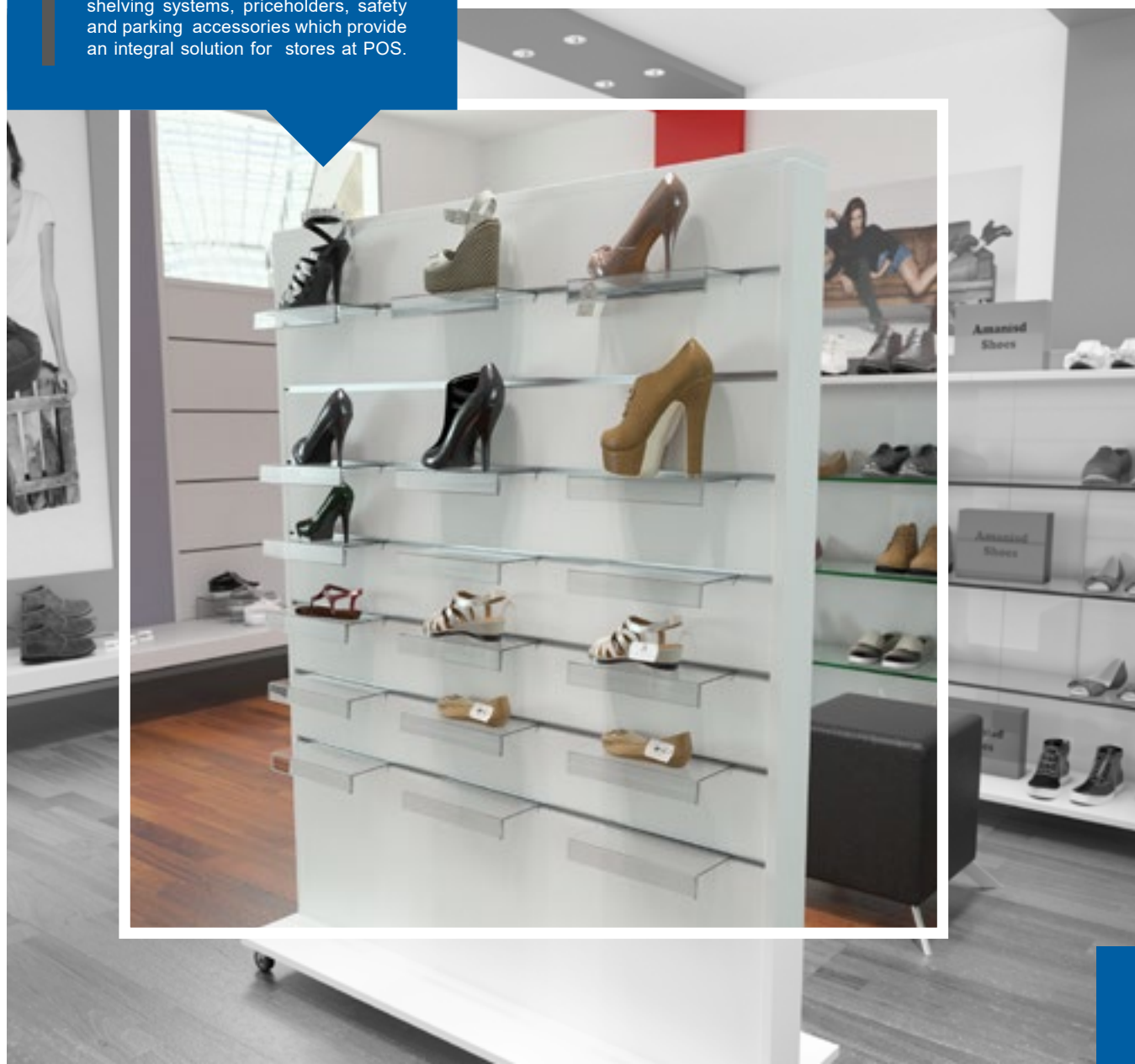



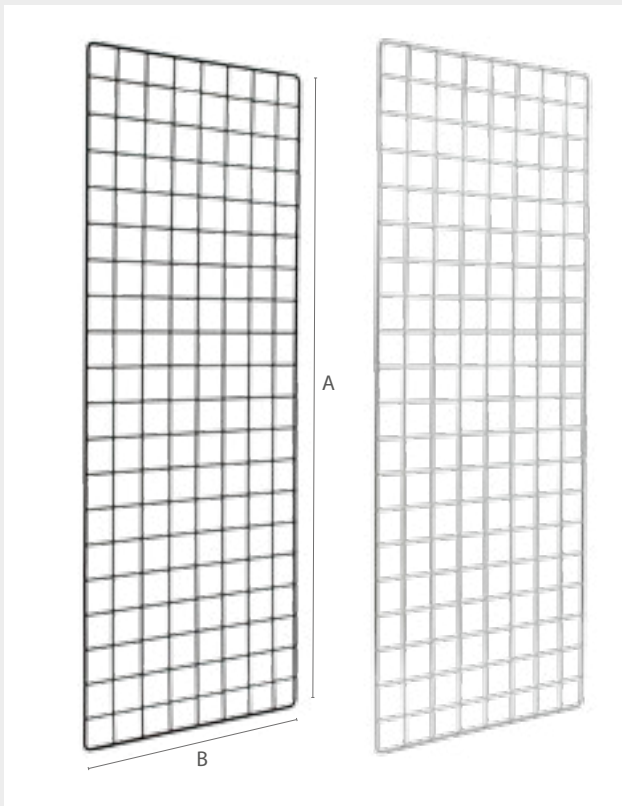





















## PANEL DETAILS











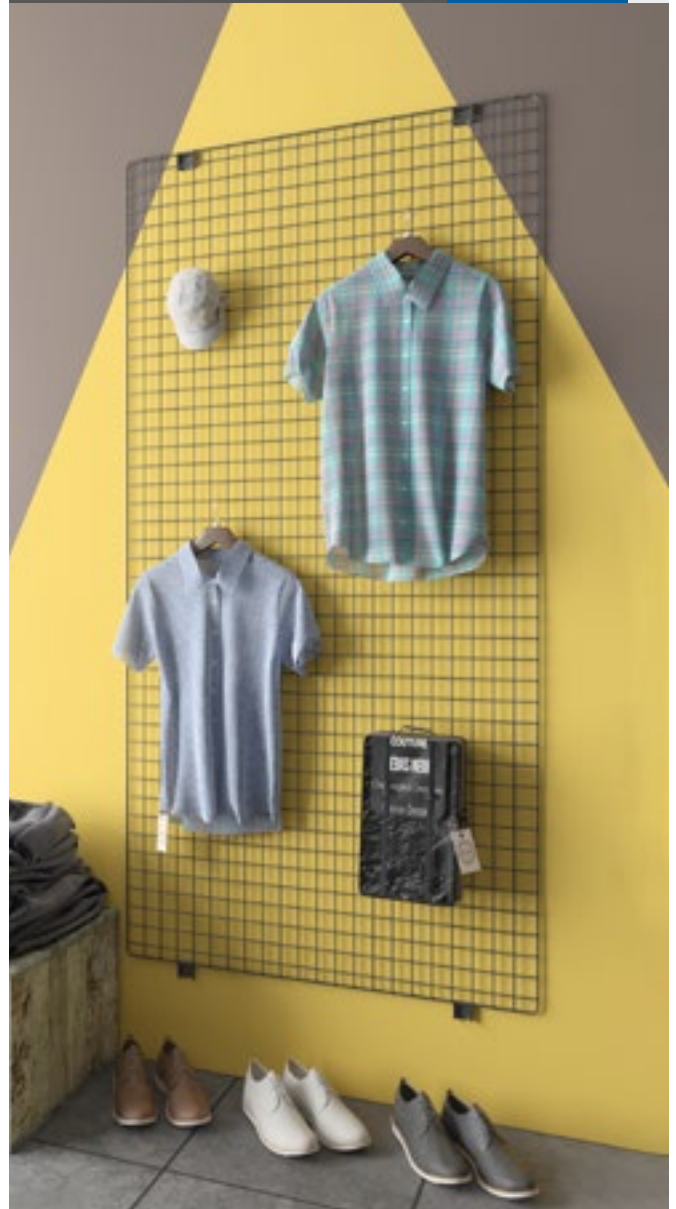















## INFORMATION

This Gridwall panel is extremely flexible system for displaying almost all type of products in any environment. Heavy duty metal construction, it is easy to install in horizontal or vertical orientation. It can be used with any standard sized hook accessories. Available in black and chrome finish.

GRIDWALL	COLOUR	SIZE (AxB)	
50.340	 Black	1000x400mm	x1 
50.340	 Chromed	1000x400mm	x1 
50.341	 Black	1000x600mm	x1 
50.341	 Chromed	1000x600mm	x1 
50.342	 Black	1000x800mm	x1 
50.342	 Chromed	1000x800mm	x1 
50.343	 Black	1000x1000mm	x1 
50.343	 Chromed	1000x1000mm	x1 
50.344	 Black	1500x400mm	x1 
50.344	 Chromed	1500x400mm	x1 
50.345	 Black	1500x600mm	x1 
50.345	 Chromed	1500x600mm	x1 

## GRIDWALL PANELS



GRIDWALL	COLOUR	SIZE (AxB)	
50.346	 Black	1500x800mm	x1 
50.346	 Chromed	1500x800mm	x1 
50.347	 Black	1500x1000mm	x1 
50.347	 Chromed	1500x1000mm	x1 
50.348	 Black	2000x400mm	x1 
50.348	 Chromed	2000x400mm	x1 
50.349	 Black	2000x600mm	x1 
50.349	 Chromed	2000x600mm	x1 
50.353	 Black	2000x800mm	x1 
50.353	 Chromed	2000x800mm	x1 
50.354	 Black	2000x1000mm	x1 
50.354	 Chromed	2000x1000mm	x1 

## PLATE DETAILS INFORMATION \*mm



This steel mounting plate is the easiest way to hang your grid mesh panels on the wall. Each panel requires at least 4 mounting plates. 2 colors available. Comes in 20 pieces pack. Screws are not included.





MOUNTING	COLOUR	SIZE	
50.261	 Black	40x40x15mm	x20 
50.261	 Grey	40x40x15mm	x20 



## CLIP HOOK

### HOOK DETAILS \*mm





"C" HOOK	LENGTH	
12.157	38mm	x100 

## "C" HOOK

### HOOK DETAILS \*mm





"C" HOOK	LENGTH	
12.155	80mm	x100 
12.156	39mm	x100 

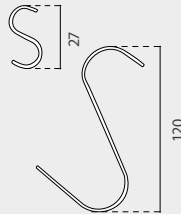

## "S" HOOK

### HOOK DETAILS \*mm



"C" HOOK	LENGTH	Ø WIRE	
12.152	27mm	Ø1.1mm	x100 
12.154	120mm	Ø2mm	x100 

## DISPLAY DETAILS

### INFORMATION \*mm

Wire steel dumpbin features a collapsible design which allows an easy setup, packing and storing. Frame spacing allows for lifts to be used during store resets. It is ideal for displaying last minute add-on items on the point of sale.

WIRE D1	QTY	N.W	G.W	C.B.M	SIZE
Packing	1	7.2kg	8.4kg	0.2	795x425x550mm
<b>50.350</b>		<b>400x400x770mm</b>			
WIRE D2	QTY	N.W	G.W	C.B.M	SIZE
Packing	1	8.8kg	10.2kg	0.27	795x620x550mm
<b>50.351</b>		<b>600x400x770mm</b>			
WIRE D3	QTY	N.W	G.W	C.B.M	SIZE
Packing	1	13.6kg	15.2kg	0.52	1205x790x550mm
<b>50.352</b>		<b>1000x600x770mm</b>			







## PRONG DETAILS INFORMATION \*mm

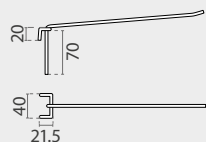

Made using heavy duty chrome finish metal. Lightweight prong for specific using with gridwall.



SINGLE PRONG	SIZE		
50.201	Ø 4x150mm	x100	
50.202	Ø 5x200mm	x100	
50.203	Ø 5x250mm	x100	
50.204	Ø 6x300mm	x100	
50.200	Ø 6x350mm	x100	

## SINGLE PRONG HOOK

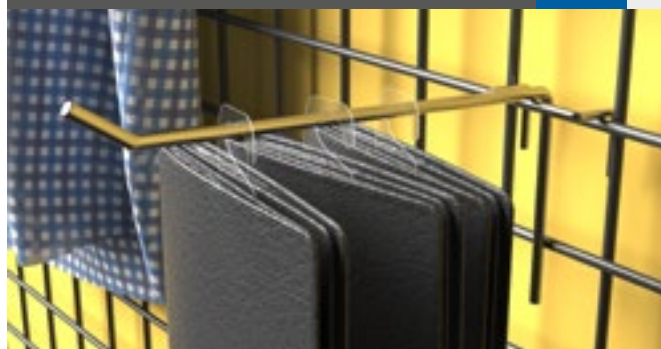





## PRONG DETAILS INFORMATION \*mm

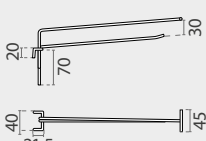

Made using heavy duty chrome finish metal. Stocked in a wide range of sizes. This gridwall prong has price holder overarm included.



SINGLE OVER.	SIZE		
50.232	Ø 4x150mm	x100	
50.233	Ø 5x200mm	x100	
50.234	Ø 5x250mm	x100	
50.235	Ø 6x300mm	x100	
50.256	Ø 6x350mm	x100	

## SINGLE PRONG HOOK WITH OVERARM







## PRONG DETAILS INFORMATION \*mm

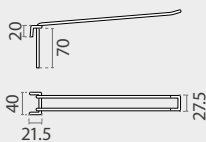

Made using heavy duty chrome finish metal. Double wire makes it sturdier. Designed for using on gridwall panels.



EURO HOOK	SIZE		
50.225	Ø 4x150mm	x100	
50.226	Ø 5x200mm	x100	
50.227	Ø 5x250mm	x100	
50.228	Ø 6x300mm	x100	
50.229	Ø 6x350mm	x100	

## EURO HOOK







## PRONG DETAILS INFORMATION \*mm



Made using heavy duty chrome finish metal. This gridwall euro prong comes with price holder overarm included.



EURO OVER.	SIZE		
50.529	Ø 4x150mm	x100	
50.530	Ø 5x200mm	x100	
50.531	Ø 5x250mm	x100	
50.532	Ø 6x300mm	x100	

## EURO HOOK WITH OVERARM

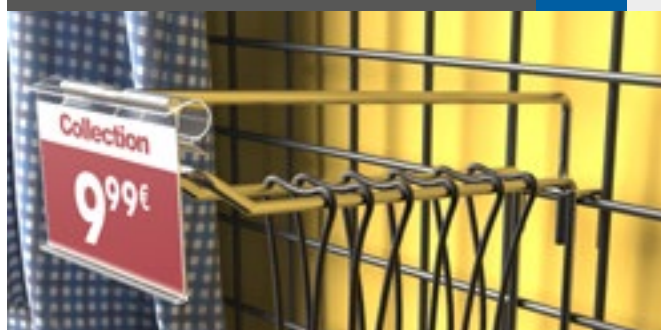

\* price holders not included

## GONDOLA DETAILS

\*mm



### INFORMATION

This double sided Slatwal Gondola without wheels allows for maximum exposure of your exhibits. Slatwall aluminium profiles included. Profiles spacing 150mm. This is a versatile display thanks to our wide range of prongs and fixtures available.

GONDOLA	SIZE	
50.159	1000x1500x400mm	x1 

## SLATWALL GONDOLA



## GONDOLA DETAILS

\*mm



### INFORMATION

This double sided Slatwal Gondola with wheels allows for maximum exposure of your exhibits. Slatwall aluminium profiles included. Profiles spacing 150mm. This is a versatile display thanks to our wide range of prongs and fixtures available.

ROLL. GONDOLA	SIZE	
50.160	1200x1550x400mm	x1 

## ROLLING GONDOLA

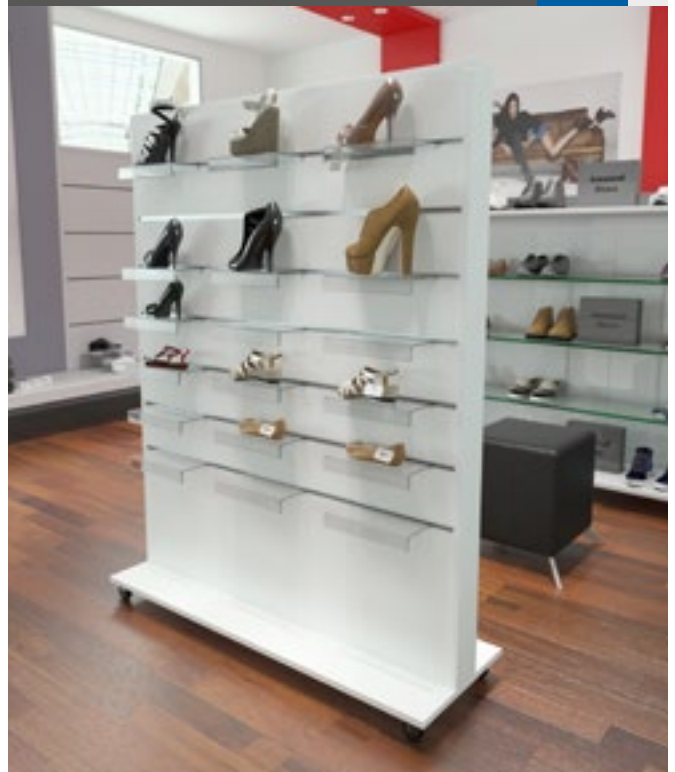



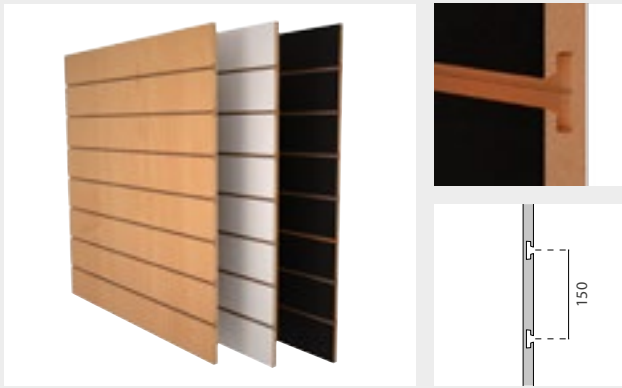

## PANELS DETAILS

\*mm



## INFORMATION

A set of two same color slatwall panels for wall mount use. Milling distance 150mm. Inserts aluminium profiles and perimetral decorative profiles are sold separately.

SLATWALL 150	SIZE	
50.155NB		
50.155W		1200x1200x19mm
50.155B		
		x2 

## SLATWALL PANEL 150





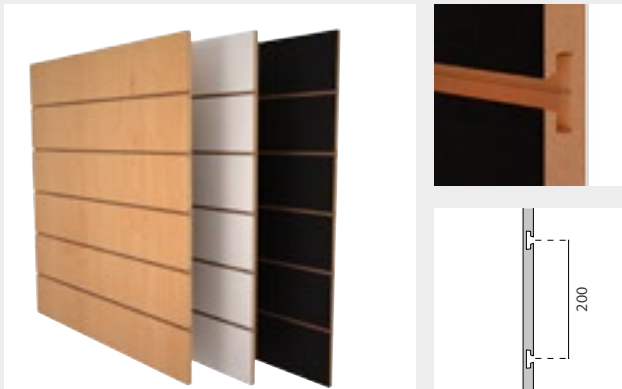

## PANELS DETAILS

\*mm



## INFORMATION

A set of two same color slatwall panels for wall mount use. Milling distance 200mm. Inserts aluminium profiles and perimetral decorative profiles are sold separately.

SLATWALL 200	SIZE	
50.156NB		
50.156W		1200x1200x19mm
50.156B		
		x2 

## SLATWALL PANEL 200



## SLATWALL ALUMINIUM PROFILE



Aluminium slatwall profiles that ensures a smooth fit into the slatwall panels and great strength.

ALUM. PROFILE	LENGTH	
50.157	1200mm	x10 

## PERIMETRAL DECORATIVE PROFILE

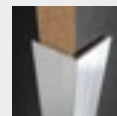

Aluminium profiles for a better finishing of our slatwall panel edges. Available in packs of four pieces.

DECO PROFILE	PROFILE	LENGTH	
50.158	20x20mm	2400mm	x4 



## PRONG DETAILS

## INFORMATION

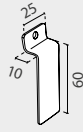
\*mm



Made using heavy duty metal and chrome finish can be used for years.

SINGLE PRONG	SIZE		
50.131	Ø 4x100mm	x100	
50.001	Ø 5x150mm	x100	
50.002	Ø 5x200mm	x100	
50.003	Ø 6x250mm	x100	
50.004	Ø 6x300mm	x100	

## SINGLE PRONG HOOK





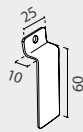

## PRONG DETAILS

## INFORMATION

\*mm



Made using heavy duty metal and chrome finish can be used for years. Overarm included to hang a price holder.

SINGLE OVER.	SIZE		
50.005	Ø 5x150mm	x100	
50.006	Ø 5x200mm	x100	
50.007	Ø 6x250mm	x100	
50.008	Ø 6x300mm	x100	

## SINGLE PRONG HOOK WITH OVERARM





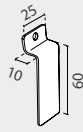

## EURO HOOK DETAILS

## INFORMATION

\*mm



Made using heavy duty metal and chrome finish can be used for years.

EURO HOOK	SIZE		
50.060	Ø 5x150mm	x100	
50.061	Ø 5x200mm	x100	
50.062	Ø 6x250mm	x100	
50.063	Ø 6x300mm	x100	

## EURO HOOK





## EURO HOOK DETAILS

## INFORMATION

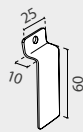
\*mm



Made using heavy duty metal and chrome finish can be used for years. Overarm included to hang a price holder.

EURO OVER.	SIZE		
50.359	Ø 5x150mm	x100	
50.360	Ø 5x200mm	x100	
50.361	Ø 5x250mm	x100	

## EURO HOOK WITH OVERARM

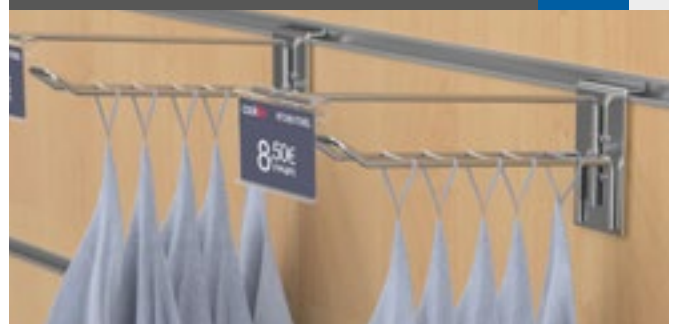

## ARM DETAILS



## INFORMATION

\*mm

Made using heavy duty metal and chrome finish. Ideal for displaying clothes in your retail store, with a ball stop end to secure your products. No tools are required to set up with a slatwall unit.

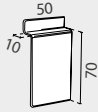

ROUND ARM

SIZE

50.033

Ø10x400mm

x25 

## ROUND STRAIGHT ARM WITH BALL END



## ARM DETAILS



## INFORMATION

\*mm

Made using heavy duty metal and chrome finish. Ideal for displaying clothes in your retail store, with multiple ball stops for spacing your products. No tools are required to set up with a slatwall unit.

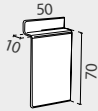

8 BALLS ROUND

SIZE

50.034

Ø10x400mm

x25 

## 8 BALLS ROUND STRAIGHT ARM



## ARM DETAILS



## INFORMATION

\*mm

Made using heavy duty metal and chrome finish. Ideal for displaying clothes in your retail store, with multiple ball stops for spacing your products. No tools are required to set up with a slatwall unit.

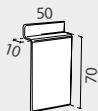

ROUND SLOPING

SIZE

50.035

Ø10x400mm

x25 

## 8 BALLS ROUND SLOPING ARM





## ARM DETAILS



## INFORMATION

\*mm

Made using heavy duty flat square oval chrome tube. Ideal for displaying and supporting the weight of various garments, with a ball stop end to secure your products. No tools required to set up with a slatwall unit.

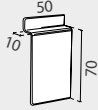

OVAL ARM SIZE

50.036 30x15x400mm x25 

## OVAL STRAIGHT ARM WITH BALL END



## ARM DETAILS



## INFORMATION

\*mm

Made using heavy duty flat square oval chrome tube. Ideal for displaying and supporting the weight of various garments, with multiple ball stops for spacing your products. No tools required to set up with a slatwall unit.

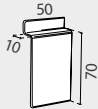

8 BALLS OVAL SIZE

50.037 30x15x400mm x25 

## 8 BALLS OVAL STRAIGHT ARM



## ARM DETAILS



## INFORMATION

\*mm

Made using heavy duty flat square oval chrome tube. Ideal for displaying and supporting the weight of various garments, with multiple ball stops for spacing your products. No tools required to set up with a slatwall unit.

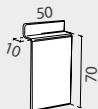

OVAL SLOPING SIZE

50.038 30x15x400mm x25 

## 8 BALLS OVAL SLOPING ARM



## ARM DETAILS

## INFORMATION \*mm

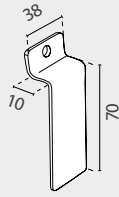

Made using heavy duty chrome finish metal. It is the ideal accessory for displaying balls or sport equipment.



BALL DISPLAY

SIZE

50.085

Ø150mm

x10



## BALL RISING DISPLAY ARM

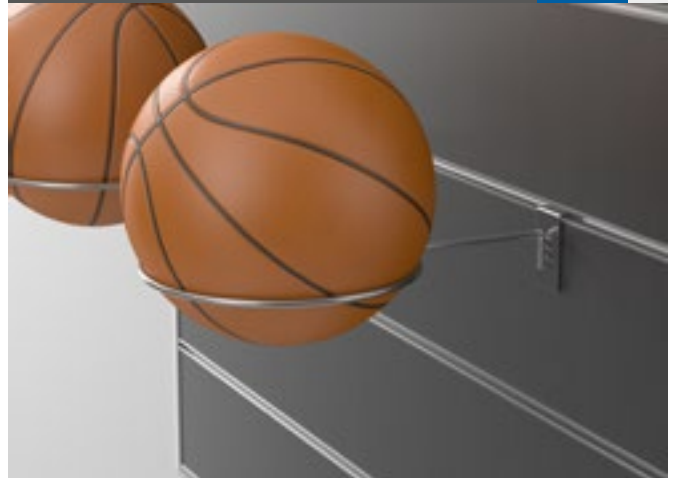

## ARM DETAILS

## INFORMATION \*mm

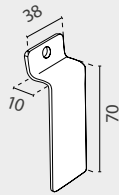

Made using heavy duty chrome finish metal. This ring is the ideal accessory for displaying baseballs caps easily.



CAP DISPLAY

SIZE

50.087

Ø150mm

x10



## BASEBALL CAP DISPLAY ARM

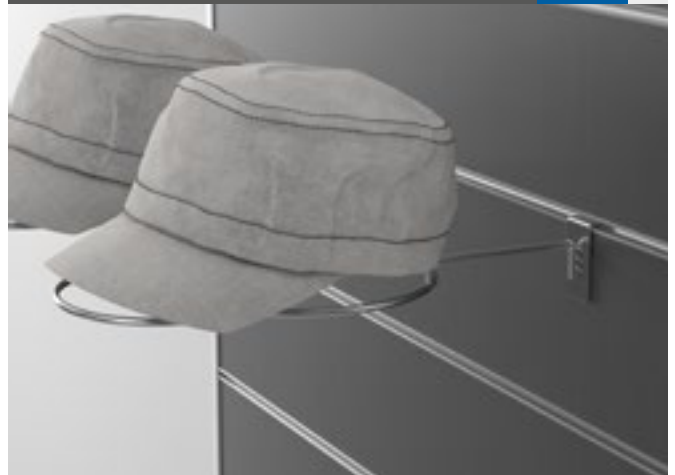

## ARM DETAILS

## INFORMATION \*mm

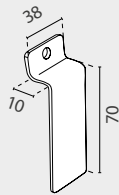

Made using heavy duty chrome finish metal. This ring is the ideal accessory for displaying hats in your store easily.

HAT DISPLAY

SIZE

50.086

Ø150mm

x10



## HAT DISPLAY ARM



## PRONG DETAILS

## INFORMATION \*mm

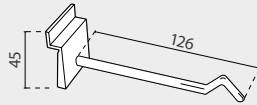

White plastic hook clip for attaching to slatwall panels. Ideal for hanging strips or lightweight products.

SLAT PRONG	SIZE	
12.111	126mm	x50 

## SLAT WALL PRONG





## HOLDER DETAILS

## INFORMATION \*mm

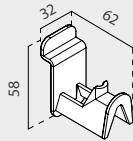

Specific accessory for presenting glasses on your slat panel. This fixture slide into the slat panels without adhesives or tools. Made of a durable transparent plastic.



GLASSES HOLDER	SIZE	
50.858	32x58x62mm	x25 

## GLASSES HOLDER FOR SLATWALL PANEL



## TRAY DETAILS

## INFORMATION \*mm

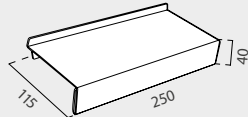

This slat wall shelving is a great addition to any slatwall display. Front folding to add a price label.

CARRY TRAY	SIZE	
50.097	250x40x115mm	x10 

## PLASTIC CARRY TRAY







## BRACKET DETAILS

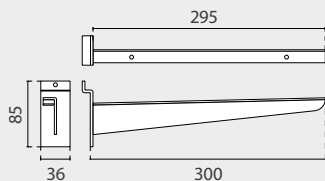

## INFORMATION \*mm

Heavy duty metal shelf chrome finish brackets, made to fit to slatwall panels. It is suitable for glass, acrylic or wooden shelves. Supplied in pairs, one left and one right.



SHELF BRACKET	SIZE	
50.069	295x85mm	x2   1 Uni  1 Uni

## SHELF BRACKET 300mm (LEFT AND RIGHT)



## PANEL DETAILS

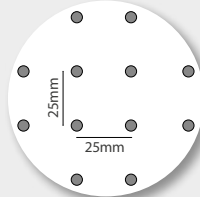
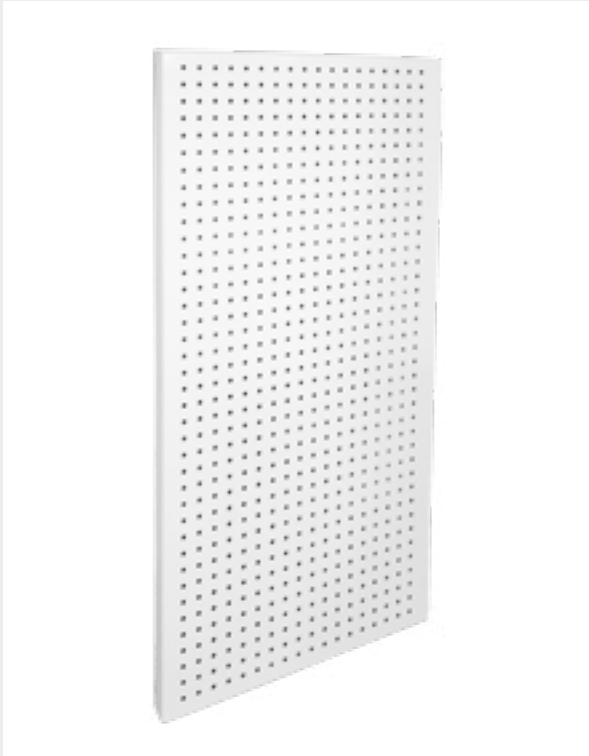

## INFORMATION

This Pegboard panel with 25mm slotting pattern is an excellent display system. Heavy duty metal construction. Rear mounting slots for vertical or horizontal installation. See our range of pegboard prongs to attach directly without tools.

PEGBOARD	SIZE	SLOTING PATTERN
50.420	500x2000mm	25mm
50.421	1000x2000mm	25mm
50.422	1000x500mm	25mm
50.423	1200x1200mm	25mm

## PEGBOARD PANELS

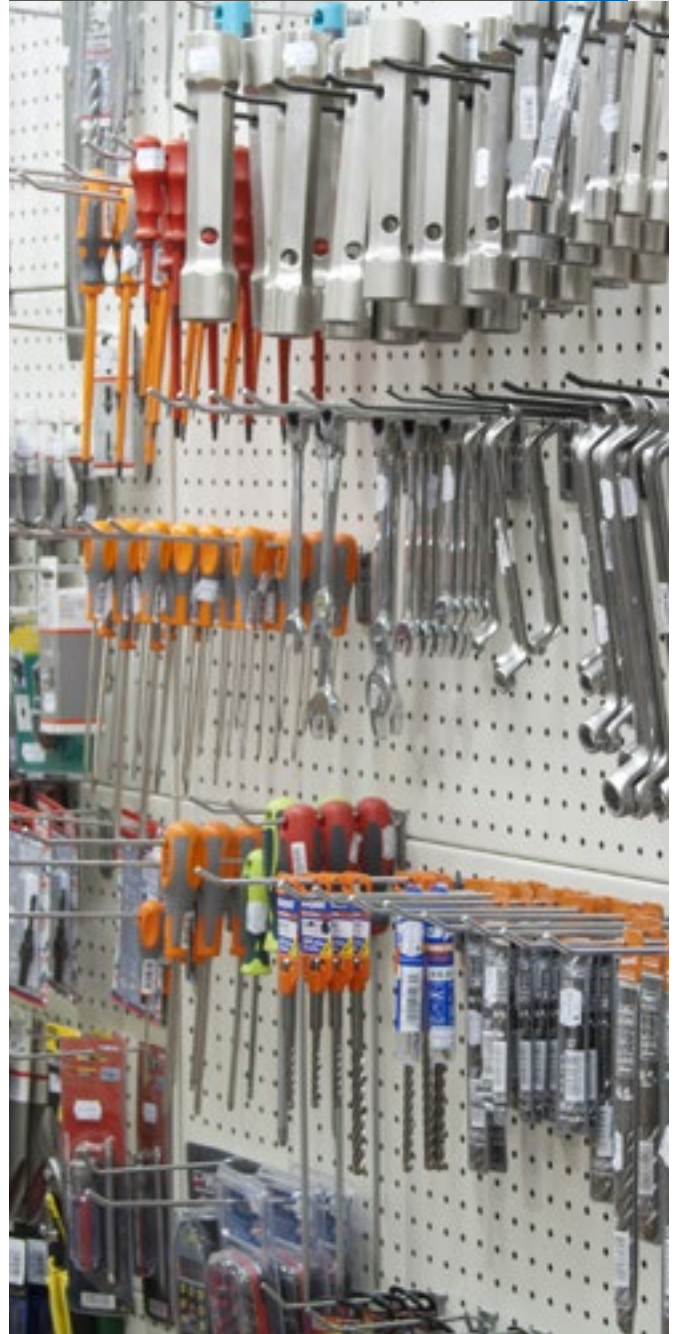

## PLATE DETAILS

## INFORMATION

\*mm



This mounting plate is designed for securing the pegboard panels to vertical surfaces, usually used on the retail store walls. 4 wall mounting plates per each pegboard panel is recommended.

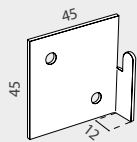

## MOUNT PLATE

## SIZE

50.430	30x15x40mm	x4  (2 left + 2 right)
--------	------------	---

## PEGBOARD MOUNTING PLATE

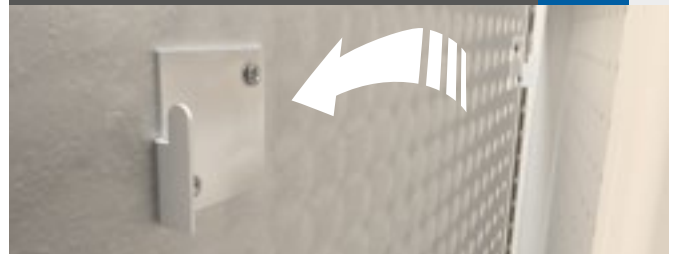

## PRONG DETAILS

## INFORMATION

\*mm

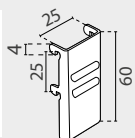

Made using heavy duty chrome finish metal. It is suitable for 25mm slotting pattern pegboard.

SINGLE PRONG	SIZE		
50.059	Ø 4x100mm	x100	
50.019	Ø 5x150mm	x100	
50.020	Ø 5x200mm	x100	
50.021	Ø 6x250mm	x100	
50.022	Ø 6x300mm	x100	
50.023	Ø 6x350mm	x100	

## SINGLE PRONG HOOK





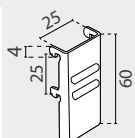

## PRONG DETAILS

## INFORMATION

\*mm



Made using heavy duty chrome finish metal. It is suitable for 25mm slotting pattern pegboard. Overarm to price holder is included.

SINGLE OVER.	SIZE		
50.024	Ø 5x150mm	x100	
50.025	Ø 5x200mm	x100	
50.026	Ø 6x250mm	x100	
50.027	Ø 6x300mm	x100	
50.028	Ø 6x350mm	x100	

## SINGLE PRONG HOOK WITH OVERARM





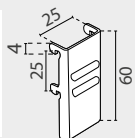

## PRONG DETAILS

## INFORMATION

\*mm



Made using heavy duty chrome finish metal. It is suitable for 25mm slotting pattern pegboard.

EURO HOOK	SIZE		
50.029	Ø 5x150mm	x100	
50.030	Ø 5x200mm	x100	
50.031	Ø 6x250mm	x100	
50.032	Ø 6x300mm	x100	

## EURO HOOK





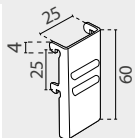

## PRONG DETAILS

## INFORMATION

\*mm



Made using heavy duty chrome finish metal. It is suitable for 25mm slotting pattern pegboard. Overarm to price holder is included.

EURO OVER.	SIZE		
50.355	Ø 5x150mm	x100	
50.356	Ø 5x200mm	x100	
50.357	Ø 6x250mm	x100	
50.358	Ø 6x300mm	x100	

## EURO HOOK WITH OVERARM





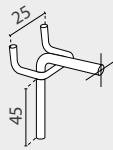

## PRONG DETAILS

## INFORMATION

\*mm



Made using heavy duty chrome finish metal. It is suitable for 25mm slotting pattern pegboard.

SINGLE WIRE	SIZE		
50.009	Ø 4x100mm	x100	
50.010	Ø 5x150mm	x100	
50.011	Ø 5x200mm	x100	
50.012	Ø 5x250mm	x100	
50.013	Ø 6x300mm	x100	

## SINGLE WIRE HOOK





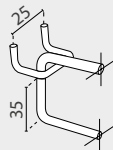

## PRONG DETAILS

## INFORMATION

\*mm



Made using heavy duty chrome finish metal. It is suitable for 25mm slotting pattern pegboard. Overarm to price holder is included.

SINGLE OVER.	SIZE		
50.014	Ø 4x100mm	x100	
50.015	Ø 4x150mm	x100	
50.016	Ø 5x200mm	x100	
50.017	Ø 5x250mm	x100	
50.018	Ø 6x300mm	x100	

## SINGLE WIRE HOOK WITH OVERARM





## PRONG DETAILS

## INFORMATION

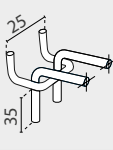
\*mm



Made using heavy duty chrome finish metal. It is suitable for 25mm slotting pattern pegboard.

EURO WIRE	SIZE		
50.070	Ø 4x150mm	x100	
50.071	Ø 5x200mm	x100	
50.072	Ø 5x250mm	x100	
50.073	Ø 6x300mm	x100	

## EURO WIRE HOOK



## PRONG DETAILS

## INFORMATION

\*mm

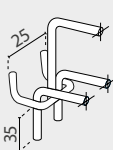

Made using heavy duty chrome finish metal. It is suitable for 25mm slotting pattern pegboard. Overarm to price holder is included.

EURO OVER.	SIZE		
50.079	Ø 5x150mm	x100	
50.076	Ø 5x200mm	x100	
50.077	Ø 5x250mm	x100	
50.078	Ø 5x300mm	x100	

## EURO WIRE HOOK WITH OVERARM

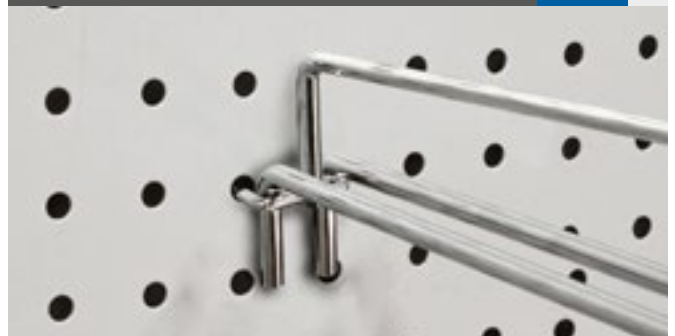

## PRONG DETAILS

\*mm

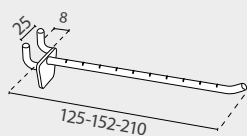

## INFORMATION

This simple prong made from sturdy plastic with notches along the hook to assist with even spacing of items, enhancing your products and display. It is suitable for 25mm slotting pattern pegboard and for slatwall.

EURO OVER.	LENGHT		
12.255	125mm	x50 	
12.256	152mm	x50 	
12.257	210mm	x50 	

## SIMPLE PEGBOARD PRONG



## PRONG DETAILS

\*mm



## INFORMATION

This double prong made from sturdy plastic with notches along the hook to assist with even spacing of items, enhancing your products and display. It is suitable for 25mm slotting pattern pegboard and for slatwall.

EURO OVER.	LENGHT		
12.252	105mm	x50 	
12.253	152mm	x50 	
12.254	210mm	x50 	

## DOUBLE PEGBOARD PRONG



## PRONG DETAILS

## INFORMATION

\*mm



This white simple white clip hook is made from sturdy plastic. It is 48mm length and it is suitable for being attaching to the pegboard panels. Ideal for hanging plastic strips, coupons, small objects or for any other temporary promotional offer at your business.

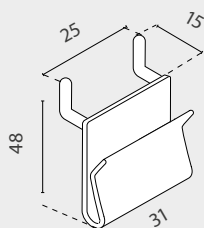

SIMPLE HOOK	SIZE		
12.483	31x48mm	x100 	

## PEGBOARD SIMPLE HOOK



# BACK RAIL SYSTEM Back Rail Arms

## RAIL DETAILS



## INFORMATION

\*mm

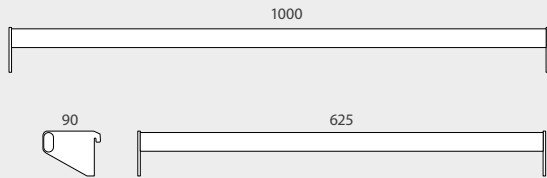

Made from steel tube is ideal for displaying and supporting the weight of various garments. Quick and easy to install is compatible with our wide range of accessories.

BACK RAIL	SIZE		
50.045	30x15x625mm	x25	
50.046	30x15x1000mm	x25	

## OVAL BACK RAIL



## RAIL DETAILS

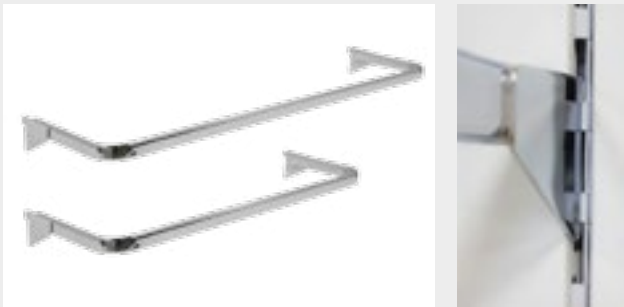

## INFORMATION

\*mm

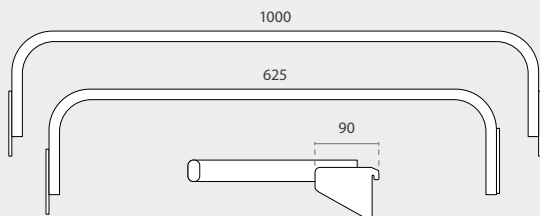

Made from steel. It is ideal for displaying and supporting the weight of various garments. With an easy set-up and compatible with our wide range of accessories.

"D" BACK RAIL	SIZE		
50.048	30x15x625mm	x25	
50.049	30x15x1000mm	x25	

## OVAL "D" BACK RAIL





# BACK RAIL SYSTEM Back Rail Arms

## ARM DETAILS



## INFORMATION

\*mm

Made using heavy duty metal and chrome finish. Ideal for displaying clothes in your retail store, with a ball stop end to secure your products. Suitable for shelving back rail.

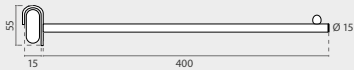

ROUND ARM

SIZE

50.039

Ø15X400mm

x25 

## ROUND STRAIGHT ARM WITH BALL END

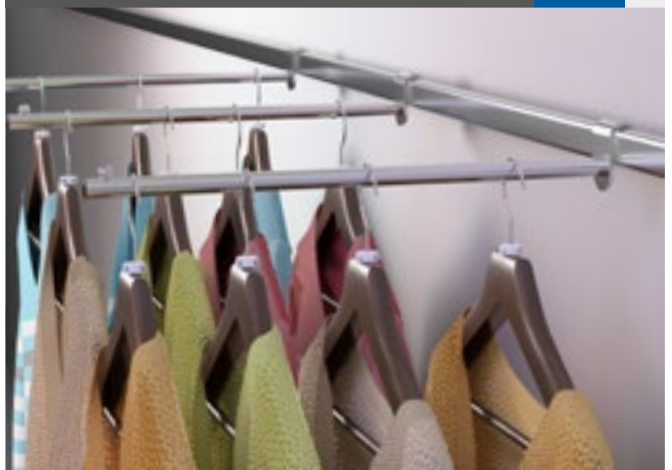

## ARM DETAILS



## INFORMATION

\*mm

Made using heavy duty metal and chrome finish. Ideal for displaying clothes, with multiple ball stops for spacing your products. Suitable for shelving back rail.

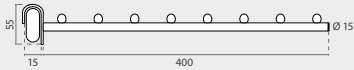

8 BALLS ROUND

SIZE

50.040

Ø15X400mm

x25 

## 8 BALLS ROUND STRAIGHT ARM

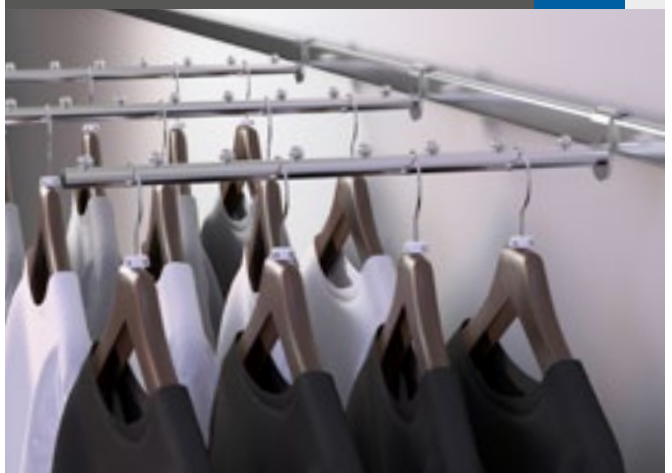

## ARM DETAILS



## INFORMATION

\*mm

Made using heavy duty metal and chrome finish. Ideal for displaying clothes, with multiple ball stops for spacing your products. Suitable for shelving back rail.

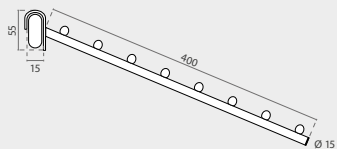

ROUND SLOPING

SIZE

50.041

Ø15X400mm

x25 

## 8 BALLS ROUND SLOPING ARM



# BACK RAIL SYSTEM Back Rail Arms

## ARM DETAILS



## INFORMATION

\*mm

Straight design made of heavy duty metal with a chromed finish and a ball stop end to secure your products. Ideal for displaying clothes. Suitable for shelving back rail.

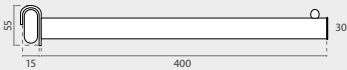

ROUND ARM          SIZE

50.042          30x15x400mm          x25 

## OVAL STRAIGHT ARM WITH BALL END

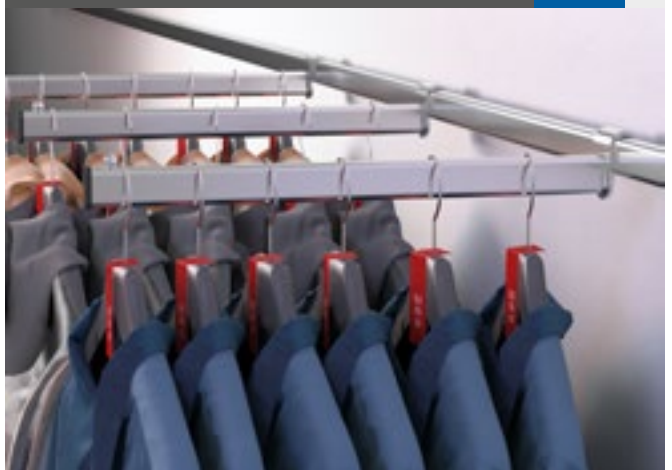

## ARM DETAILS



## INFORMATION

\*mm

Straight design made of heavy duty metal with a chromed finish and multiple ball stops for spacing your products. Ideal for displaying clothes. Suitable for shelving back rail.

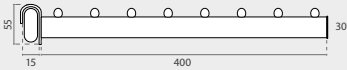

8 BALLS OVAL          SIZE

50.043          30x15x400mm          x25 

## 8 BALLS OVAL STRAIGHT ARM

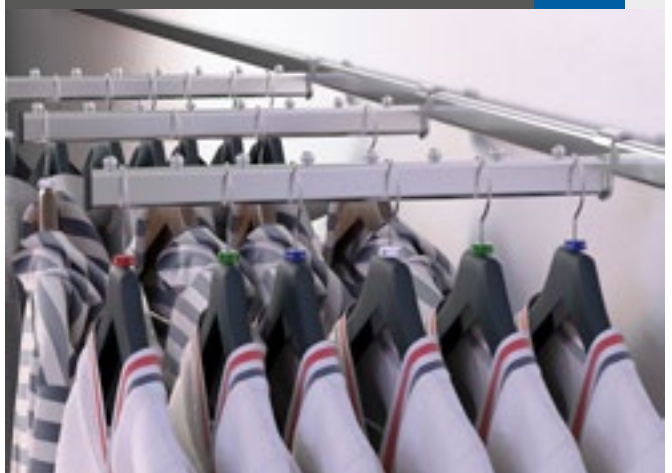

## ARM DETAILS



## INFORMATION

\*mm

Sloping design made of heavy duty metal with a chromed finish and multiple ball stops for spacing your products. Ideal for displaying clothes. Suitable for shelving back rail.

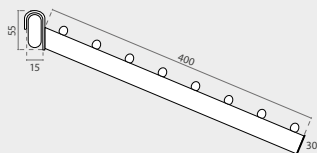

OVAL SLOPING          SIZE

50.044          30x15x400mm          x25 

## 8 BALLS OVAL SLOPING ARM

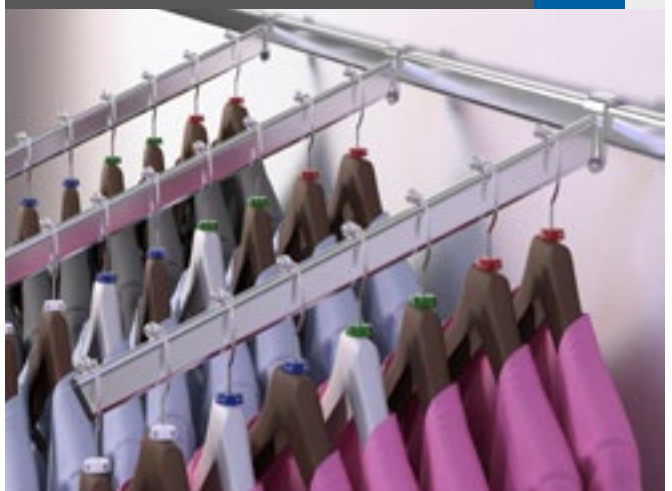

# BACK RAIL SYSTEM Back Rail Prongs

## PRONG DETAILS

## INFORMATION

\*mm

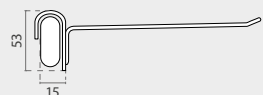

Made using heavy duty metal with chrome finish. This prong is suitable for shelving back bar rail.

### SINGLE PRONG

### SIZE

50.051	Ø 5x200mm	x100 	
50.052	Ø 6x250mm	x100 	
50.053	Ø 6x300mm	x100 	
50.054	Ø 6x350mm	x100 	

## SINGLE PRONG HOOK

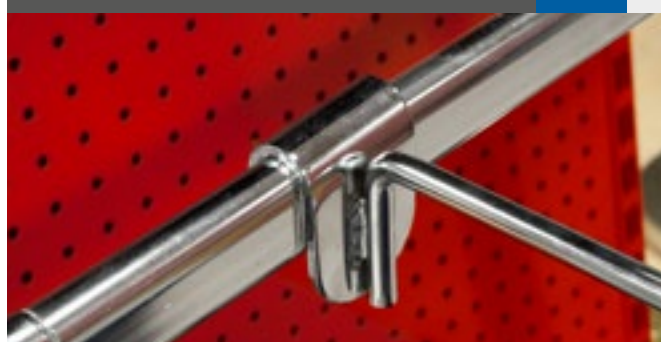

## PRONG DETAILS

## INFORMATION

\*mm

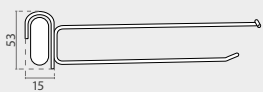

Made using heavy duty chrome finish metal. Suitable for shelving backrail with priceholder overarm.

### SINGLE OVER.

### SIZE

50.064	Ø 5x200mm	x100 	
50.065	Ø 6x250mm	x100 	
50.066	Ø 6x300mm	x100 	
50.067	Ø 6x350mm	x100 	

## SINGLE PRONG HOOK WITH OVERARM



## PRONG DETAILS

## INFORMATION

\*mm

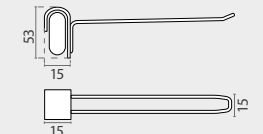

Made using heavy duty metal with chrome finish. This prong is suitable for shelving back bar rail.

### EURO HOOK

### SIZE

50.055	Ø 5x200mm	x100 	
50.056	Ø 6x250mm	x100 	
50.057	Ø 6x300mm	x100 	
50.058	Ø 6x350mm	x100 	

## EURO HOOK



## PRONG DETAILS

## INFORMATION

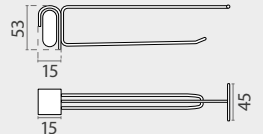

\*mm



Made using heavy duty chrome finish metal. Suitable for shelving backrail with priceholder overarm.

### EURO OVER.

### SIZE

50.456	Ø 5x200mm	x100 	
50.457	Ø 5x250mm	x100 	
50.458	Ø 6x300mm	x100 	

## EURO HOOK WITH OVERARM



## HOLDER DETAILS

## INFORMATION

\*mm



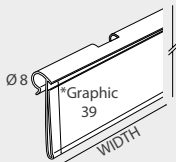

Clear extruded PVC sign holder for hooks with T ended overarms. Available in 3 different lengths. This straight price holder is ideal for displaying sales and prices on hooks.



STRAIGHT

WIDTH

50.107	53mm	x100 	
50.100	65mm	x100 	
50.101	105mm	x100 	

## STRAIGHT PRICE HOLDER FOR HOOKS



## HOLDER DETAILS

## INFORMATION

\*mm



Clear extruded PVC sign holder for hooks with T ended overarms. Available in 2 different lengths. This straight price holder is ideal for displaying sales and prices on hooks.

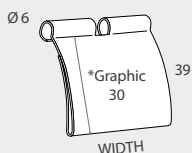

STRAIGHT

WIDTH

50.102	53mm	x100 	
50.109	65mm	x100 	

## CURVED PRICE HOLDER FOR HOOKS



## HOLDER DETAILS

## INFORMATION

\*mm



This overarm label holder is made of transparent plastic and it has a space for inserting the promotion card or label price (27x31mm).

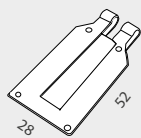

OVERARM LABEL

GRAPHIC SIZE

50.123	27x31mm	x100 	
--------	---------	--	--

## OVERARM LABEL HOLDER



## HOLDER DETAILS

## INFORMATION

\*mm



This label holder is made of transparent plastic. It has space to insert promotions or price labels (size: 27x31mm). It is ideal for the euro hooks.

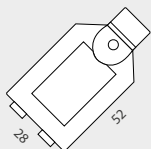

EURO LABEL

GRAPHIC SIZE

50.119	27x31mm	x100 	
--------	---------	--	--

## EURO HOOK LABEL HOLDER



## GRIPPER DETAILS

## INFORMATION

\*mm



This front gripper is made of transparent plastic and it has a gripper for attaching price labels. It is ideal for placing in front of hooks or wire baskets.

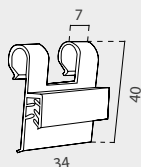

FRONT GRIPPER

SIZE

12.230	34x40mm	x100 	
--------	---------	--	--

## HOOK FRONT GRIPPER



## GRIPPER DETAILS INFORMATION \*mm



This hook stopper is made of transparent plastic and has a gripper for attaching promotion cards or price labels in front of the prongs.

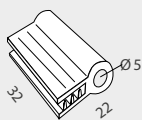

### STOPPER GRIPPER LENGTH

12.450	32mm	x100 
--------	------	--

## HOOK STOPPER GRIPPER



## LIMITER DETAILS INFORMATION \*mm



This rounded stock limiter is ideal for reducing the stock amount on the prong and also, for keeping organized the products among the prongs.



### ROUND LIMITER DIAMETER

12.280	Ø26mm	x100 
--------	-------	--

## ROUND STOCK LIMITER



## LIMITER DETAILS INFORMATION \*mm



Used to delimit and manage stock in prongs. Attaches and detaches quickly and easily. It is designed to fit on hooks 6-7mm diameter.



### SIMPLE LIMITER SIZE

12.282	9x17mm	x100 
--------	--------	---

## SIMPLE HOOK STOCK LIMITER



## LIMITER DETAILS INFORMATION \*mm



This stock limiter is ideal for holding merchandise forward on hook and keeping products organized. Fits on Double Prong Eurohook.



### DOUBLE LIMITER DIAMETER

12.281	Ø26mm	x100 
--------	-------	--

## DOUBLE HOOK STOCK LIMITER



## LIMITER DETAILS INFORMATION \*mm



This stock limiter made of clear plastic is ideal for reducing the stock amount on the prongs. And it is suitable for hooks diameter from 4 to 8mm.

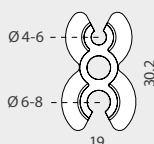

### MULTI LIMITER HOOK DIAMETER

12.549	Ø4-8mm	x50 
--------	--------	---

## MULTI HOOK STOCK LIMITER



## HANGER DETAILS INFORMATION \*mm



Made of 0.04mm PVC and it has a front adhesive. Ideal for hanging foam board, cardboard, posters on walls, ceiling or hanging from prongs.

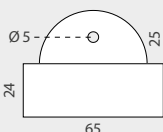

### PVC HANGER SIZE

12.512	65x49mm	x50 
--------	---------	---

## ADHESIVE PVC HANGER



HANG TAB DETAILS

INFORMATION

\*mm

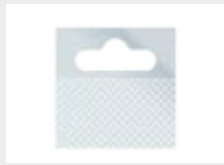

The Euroslot clear plastic hang tab is designed for hanging products on prongs. Max. recommended weight of 450 grams.

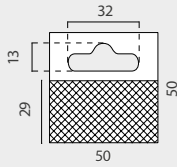

EUROSLOT	SIZE	MAX. WEIGHT	
12.357	50x50mm	450 g.	x100 

EUROSLOT



HANG TAB DETAILS

INFORMATION

\*mm



The Standard clear plastic hang tab is designed for hanging products on prongs. Max. recommended weight of 110 grams.

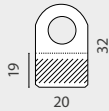

STANDARD	SIZE	MAX. WEIGHT	
12.358	20x32mm	110 g.	x100 

STANDARD



HANG TAB DETAILS

INFORMATION

\*mm



The Flexi transparent plastic hang tab is designed for hanging products on prongs. Max. recommended weight of 230 grams.

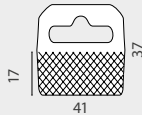

FLEXI	SIZE	MAX. WEIGHT	
12.359	41x37mm	230 g.	x100 

FLEXI



HANG TAB DETAILS

INFORMATION

\*mm



The Hook transparent plastic hang tab is designed for hanging products on prongs. Max. recommended weight of 120 grams.

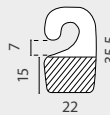

HOOK	SIZE	MAX. WEIGHT	
12.360	22x35.5mm	120 g.	x100 

HOOK



HANG TAB DETAILS

INFORMATION

\*mm



Easy transparent plastic hang tab is designed for hanging products on prongs. Max. recommended weight of 185 grams.

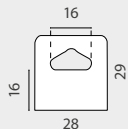

EASY	SIZE	MAX. WEIGHT	
12.361	28x29mm	185 g.	x100 

EASY



HANG TAB DETAILS

INFORMATION

\*mm



The Nova transparent plastic hang tab is designed for hanging products on prongs. Max. recommended weight of 400 grams.

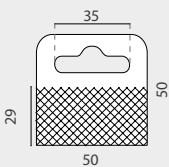

NOVA	SIZE	MAX. WEIGHT	
12.362	50x50mm	400 g.	x100 

NOVA



HANG TAB DETAILS

INFORMATION

\*mm



The Folding clear plastic hang tab is designed for hanging products on prongs. Max. recommended weight of 230 grams..



FOLDING	SIZE	MAX. WEIGHT	
12.363	41x37mm	230 g.	x100 

FOLDING



HANG TAB DETAILS

INFORMATION

\*mm



The Quick plastic hang tab is designed for hanging products on prongs. Max. recommended weight of 400 grams..

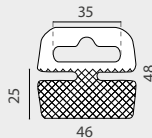

QUICK	SIZE	MAX. WEIGHT	
12.364	46x48mm	400 gr.	x100 

QUICK



HANG TAB DETAILS

INFORMATION

\*mm



The Use transparent plastic hang tab is designed for hanging products on prongs. Max. recommended weight of 400 grams.

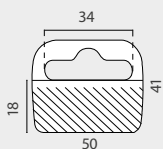

USE	SIZE	MAX. WEIGHT	
12.365	50x41mm	400 g.	x100 

USE



HANG TAB DETAILS

INFORMATION

\*mm



The Hangtab made of transparent plastic is ideal for repairing or reinforcing hang tabs.

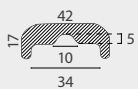

HANGTAB	SIZE	MAX. WEIGHT	
12.366	42x17mm	400 g.	x100 

HANGTAB









## LOCK DETAILS



## INFORMATION

This magnetic lock for prongs from 6 to 8mm diameter is an affordable, effective, and easy to use theft deterrent device. Available in black or white.

LOCK	COLOURS	MAX. HOOK DIAMETER			
50.365	 	6mm			x25 
50.367	 	8mm			x25 

## MAGNETIC LOCK FOR SINGLE HOOK

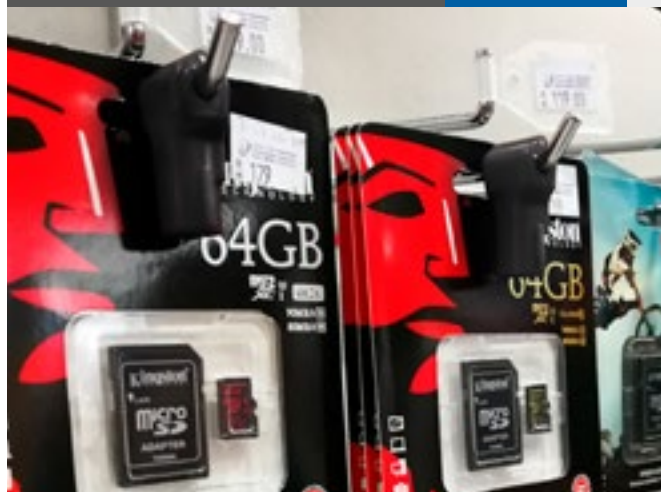

## LOCK DETAILS



## INFORMATION

This magnetic lock for euro hook is an affordable, effective, and easy to use theft deterrent device. Available in black or white.

STOPLOCK	COLOUR	SIZE			
50.369	 	45x35mm			x25 

## STOPLOCK FOR DOUBLE HOOK

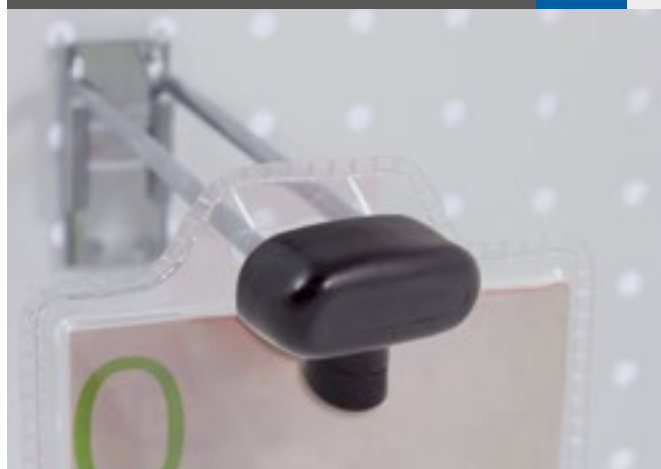

## LOCK DETAILS



## INFORMATION

This is a handy compact detacher with a handy clip for attaching to keys or work pass. Place this detacher at bottom of magnetic lock to unlock.

STOPLOCK	SIZE			
50.368	45x35mm		x1	

## DETACHER MINI STOPLOCK

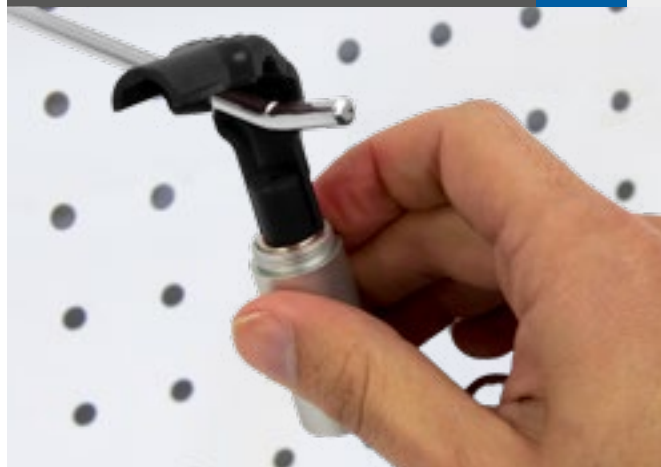



LOCK DETAILS

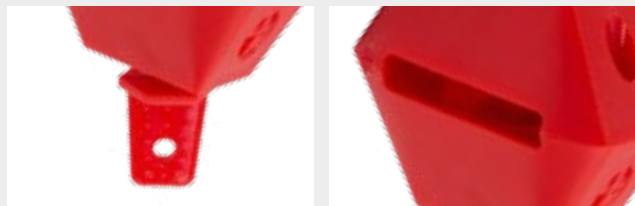

INFORMATION

\*mm

These hooks are an affordable, effective, and easy-to-use theft deterrent device. It includes key lock. Cap covers the end of the hook. Ideal for retail shops, digital stores, cell phone stores, book stores, pharmacies or shopping malls.

END'S LOCK

SIZE

12.528

65x50x25mm



x20 

HOOK END'S LOCK  
FOR EURO HOOK



LOCK DETAILS



INFORMATION

\*mm

These hooks are an affordable, effective, and easy-to-use theft deterrent device. It includes key lock. Red color finish. Ideal for retail shops, digital stores, cell phone stores, book stores, pharmacies or shopping malls.

END'S LOCK

SIZE

12.529

46x42x15mm



x20 

HOOK LOCK  
FOR EURO HOOK



# LINE PROFILES Junction Profiles

## PROFILE DETAILS



## INFORMATION

\*mm

This shelf profile is suitable for being used with 30mm or 40mm height labels and it allows to be fitted on most of the standard glass shelves. It is ideal for improvising the overall look of the shelf fronts, showcases and for highlighting the promotions of products for sale.

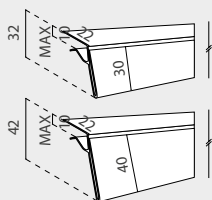

REF  
50.265  
50.266

REF  
50.270  
50.271

GLASS	COLOR	LENGTH	GRAPHIC HEIGHT	
50.265		1000mm	30mm	x25 
50.266		1320mm	30mm	x25 
50.270		1000mm	40mm	x25 
50.271		1320mm	40mm	x25 

## GLASS PRICE HOLDER PROFILE



## PROFILE DETAILS



## INFORMATION

\*mm

This Price Holder Profile is suitable for being used with 39mm height labels and Ø10mm wire shelves. There are 2 Holder Profile lengths available and white or transparent to choose from. It is ideal for improvising the overall look of the shelf fronts, wire dumpbins, wire baskets and for highlighting the promotions of products for sale.

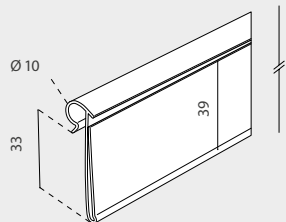

WIRE	COLOR	LENGTH	GRAPHIC HEIGHT	
50.219		1000mm	39mm	x25 
50.220		1320mm	39mm	x25 

## WIRE PRICE HOLDER PROFILE



## PROFILE DETAILS



## INFORMATION

\*mm

This shelf profile is suitable for being used with 30mm height labels and it allows to be fitted on most of the standard shelf fronts thanks to its adhesive strip at the top. There are two profile lengths available and white or transparent to choose from. It is ideal for improving the overall look of the shelf fronts in the store and for highlighting the promotions of the products for sale.

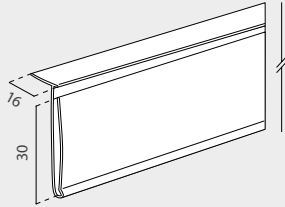

L-30	COLOR	LENGTH	GRAPHIC HEIGHT	
50.222	<input type="checkbox"/> <input checked="" type="checkbox"/>	1000mm	30mm	x25 
50.221	<input type="checkbox"/> <input checked="" type="checkbox"/>	1320mm	30mm	x25 

## L-30 ADHESIVE PROFILE



## PROFILE DETAILS





## INFORMATION

\*mm

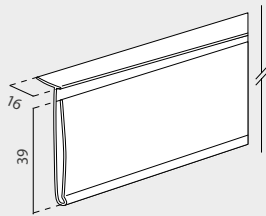
This shelf profile is suitable for being used with 39mm height labels and it allows to be fitted on most of the standard shelf fronts thanks to its adhesive strip at the top. There are 3 profile lengths available and white or transparent to choose from. Ideal for improving the overall look of the shelf fronts in the store and for highlighting the promotions of the products for sale.



L-39	COLOR	LENGTH	GRAPHIC HEIGHT	
50.223	<input type="checkbox"/> <input checked="" type="checkbox"/>	1000mm	39mm	x25 
50.224	<input type="checkbox"/> <input checked="" type="checkbox"/>	1320mm	39mm	x25 
50.117	<input type="checkbox"/> <input checked="" type="checkbox"/>	2700mm	39mm	x25 

## L-39 ADHESIVE PROFILE



## PROFILE DETAILS

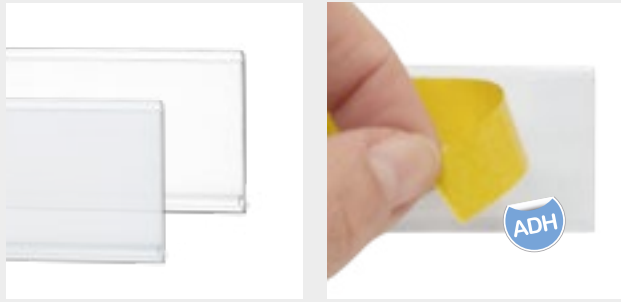

## INFORMATION

\*mm

This shelf profile is suitable for being used with 26mm height labels and it allows to be fitted on most of the standard shelf fronts thanks to its double adhesive strips at the back. There are 3 profile lengths available and white or transparent to choose from. Ideal for improving the overall look of the shelf fronts in the store and for highlighting the promotions of the products for sale.

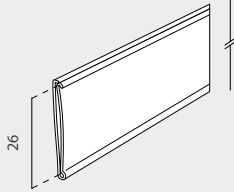

A-26	COLOR	LENGTH	GRAPHIC HEIGHT	
50.211	<input type="checkbox"/> <input checked="" type="checkbox"/>	1000mm	26mm	x25 
50.212	<input type="checkbox"/> <input checked="" type="checkbox"/>	1320mm	26mm	x25 
50.268	<input type="checkbox"/> <input checked="" type="checkbox"/>	2700mm	26mm	x25 

## A-26 ADHESIVE PROFILE



## PROFILE DETAILS



## INFORMATION

\*mm

This shelf profile is suitable for being used with 30mm height labels and it allows to be fitted on most of the standard shelf fronts thanks to its double adhesive strips at the back. There are 3 profile lengths available and white or transparent to choose from (transparent only for 1000mm and 1320mm). Ideal for improving the overall look of the shelf fronts and for highlighting the promotions of products for sale.

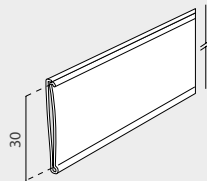

A-30	COLOR	LENGTH	GRAPHIC HEIGHT	
50.213	<input type="checkbox"/> <input checked="" type="checkbox"/>	1000mm	30mm	x25 
50.214	<input type="checkbox"/> <input checked="" type="checkbox"/>	1320mm	30mm	x25 
50.114	<input type="checkbox"/> <input checked="" type="checkbox"/>	2700mm	30mm	x25 

## A-30 ADHESIVE PROFILE



## PROFILE DETAILS

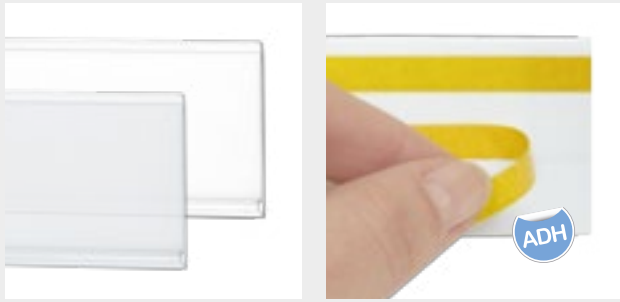

## INFORMATION

\*mm

This shelf profile is suitable for being used with 40mm height labels and it allows to be fitted on most of the standard shelf fronts thanks to its double adhesive strips at the back. There are 3 profile lengths available and white or transparent to choose from. Ideal for improving the overall look of the shelf fronts in the store and for highlighting the promotions of the products for sale.

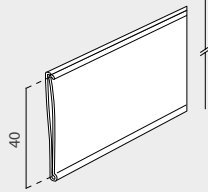

A-40	COLOR	LENGTH	GRAPHIC HEIGHT	
50.208		1000mm	40mm	x25 
50.209		1320mm	40mm	x25 
50.210		2700mm	40mm	x25 

## A-40 ADHESIVE PROFILE



## PROFILE DETAILS

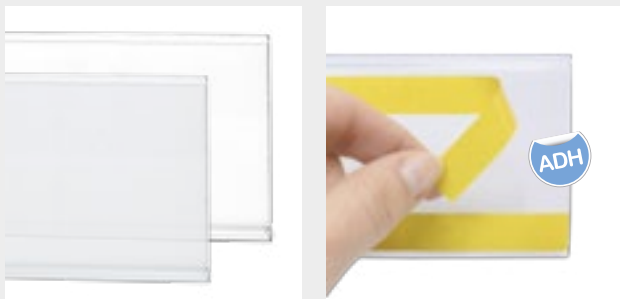

## INFORMATION

\*mm

This shelf profile is suitable for being used with 60mm height labels and it allows to be fitted on most of the standard shelf fronts thanks to its double adhesive strips at the back. There are 3 profile lengths available and white or transparent to choose from. Ideal for improving the overall look of the shelf fronts in the store and for highlighting the promotions of the products for sale.

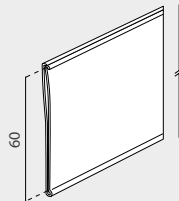

A-60	COLOR	LENGTH	GRAPHIC HEIGHT	
50.215		1000mm	60mm	x25 
50.216		1320mm	60mm	x25 
50.217		2700mm	60mm	x25 

## A-60 ADHESIVE PROFILE



STOPPER DETAILS





INFORMATION

\*mm

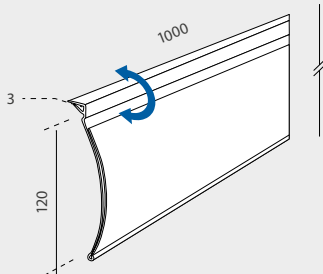
This transparent Stopper with hinge features a remarkable curved shape and a 1000mm length. Also it is suitable for being used with 120mm height labels and it allows to be fitted on most of the standard shelf profiles thanks to its hinged gripper at the top. Ideal for improving the overall look of the shelf fronts and for highlighting the promotions of products for sale.



CURVED H.	COLOR	LENGTH	GRAPHIC HEIGHT	
50.254		1000mm	120mm	x25 

CURVED HINGE STOPPER



STOPPER DETAILS





INFORMATION

\*mm

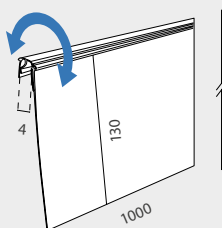
This transparent Stopper with hinge features a straight shape and a 1000mm length. Also it is suitable for being used with 130mm graphic height labels and it allows to be fitted on most of the standard shelf profiles thanks to its hinged gripper at the top. Ideal for improving the overall look of the shelf fronts and for highlighting the promotions of products for sale.



STRAIGHT H.	COLOR	LENGTH	GRAPHIC HEIGHT	
50.255		1000mm	130mm	x25 

STRAIGHT HINGE STOPPER



PROFILE DETAILS



INFORMATION

\*mm

This shelf Extension Profile is suitable for being used with the most of the standard shelf fronts thanks to its adhesive strip at the front, also is suitable for being used with 26mm height price labels. This Extension Profile is ideal for improvising the overall look of the shelf fronts in the store and for highlighting the products on sale.

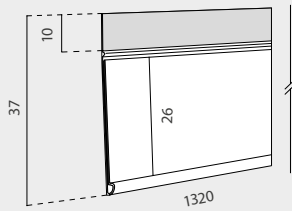

ADHESIVE EXT.	COLOR	LENGTH	GRAPHIC HEIGHT	
50.246		1320mm	26mm	x25 

ADHESIVE EXTENSION FOR PROFILE



PROFILE DETAILS

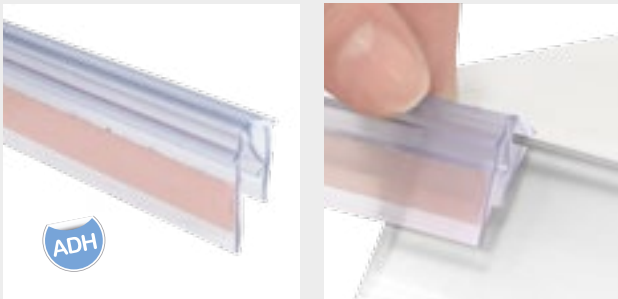

INFORMATION

\*mm

This shelf transparent profile features a front adhesive for attaching labels and it can be used on most of the standard shelf fronts thanks to its hinged clip at the back. There are 3 profile lengths available. Ideal for improvising the overall look of the shelf fronts in the store and for highlighting the promotions of the products for sale.

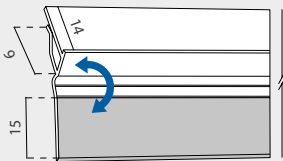

HINGE	COLOR	LENGTH	
50.105		120mm	x100 
50.106		150mm	x100 
50.250		2000mm	x25 

ADHESIVE HINGE PROFILE



## RAIL DETAILS

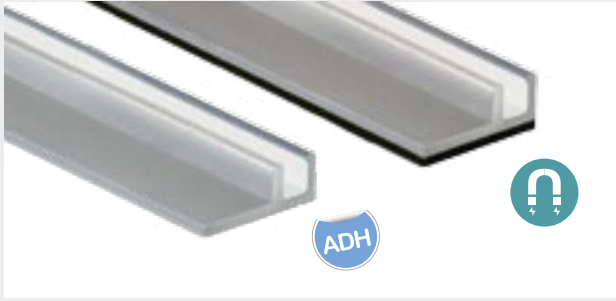







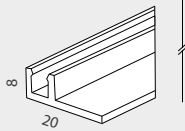

## INFORMATION

\*mm

These 8mm height rails are suitable for being used with all our dividers. There is magnetic and adhesive option available and also, 1000mm or 1320mm length for both options. They are ideal for creating an appropriate organization on the shelves management.



RAIL	LENGTH		
50.508	1320mm	x10 	 
50.514	1000mm	x10 	 
50.510	1320mm	x10 	 
50.516	1000mm	x10 	 

## RAIL FOR DIVIDER



## RAIL DETAILS

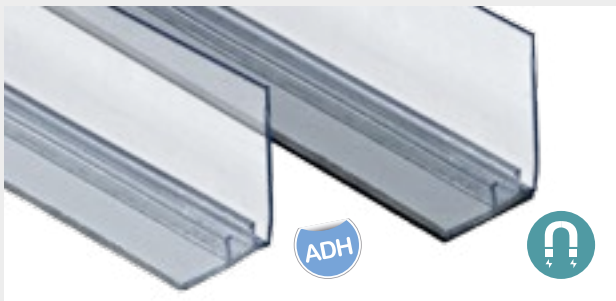







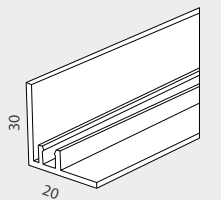



## INFORMATION

\*mm

These 30mm height rails are suitable for being used with all our dividers. There is magnetic and adhesive option available and also, 1000mm or 1320mm length for both options. They are ideal for creating an appropriate organization on the shelves management.



FRONT HEAD	LENGTH		
50.507	1320mm	x10 	 
50.517	1000mm	x10 	 
50.509	1320mm	x10 	 
50.515	1000mm	x10 	 

## RAIL FOR DIVIDER WITH FRONT HEAD

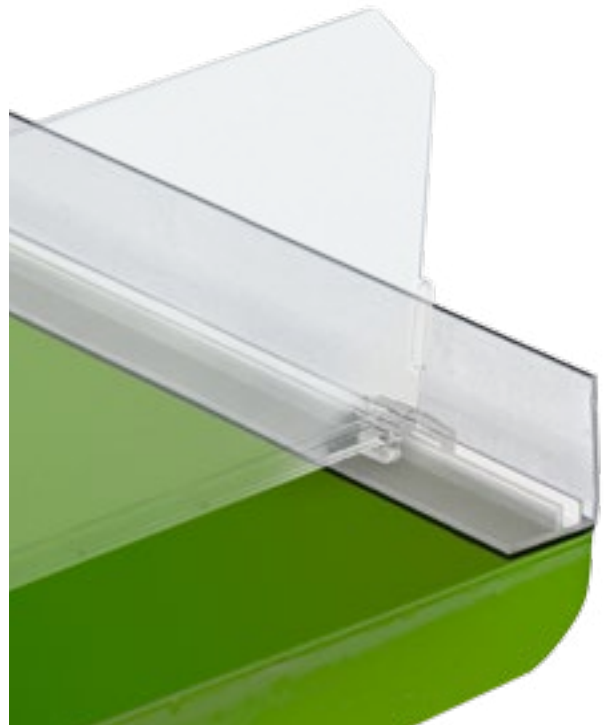



## DIVIDER DETAILS



## INFORMATION

\*mm

These 60mm height dividers are suitable for being used with all our rails. They are ideal for creating an appropriate organization on the shelves management. There are 280mm, 380mm and 480mm length available. They are usually used to separate medium-sized products like boxes cans or other goods.

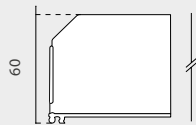

DIVIDER 60	SIZE		
50.504	60x280mm	x25 	
50.505	60x380mm	x25 	
50.506	60x480mm	x25 	

## SHELF DIVIDER 60 HIGH



## DIVIDER DETAILS



## INFORMATION

\*mm

These 120mm height dividers are suitable for being used with all our rails. They are ideal for creating an appropriate organization on the shelves management. There are 280mm, 380mm and 480mm length available. They are usually used to separate medium-sized products like boxes cans or other goods.

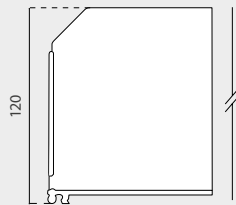

DIVIDER 120	SIZE		
50.501	120x280mm	x25 	
50.502	120x380mm	x25 	
50.503	120x480mm	x25 	

## SHELF DIVIDER 120 HIGH



## DIVIDER DETAILS



## INFORMATION

\*mm

These 180mm height dividers can be easily separated by hand, so this way, they are 3 different lengths available (280, 380 and 480mm). They are ideal for creating an appropriate management on the shelves. They are often used to separate all types of products, like boxes, bottles, food, cans or other goods and also, the products can be easily removed thanks to the lack of a front stop.

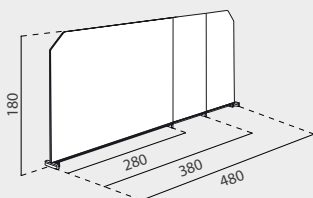

NO FRONT SIZE

50.560 280/380/480x180mm

x20 

## SECTIONABLE SHELF DIVIDER



## DIVIDER DETAILS

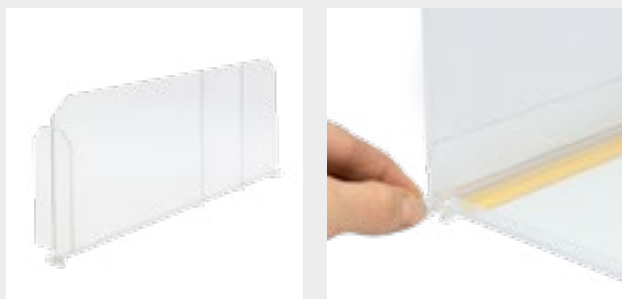

## INFORMATION

\*mm

These 180mm height dividers can be easily separated by hand, so this way, they are 3 different lengths available (280, 380 and 480mm). They are ideal for creating an appropriate management on the shelves. They are often used to separate all types of products, like boxes, bottles, food, cans or other goods and also, thanks to its front stop, the products are perfectly arranged on both sides of the shelf.

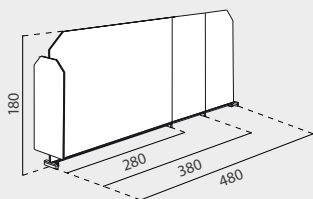

"T" FRONT SIZE

50.561 280/380/480x180mm

x20 

## SECTIONABLE SHELF DIVIDER WITH "T" FRONT



## DIVIDER DETAILS



## INFORMATION

\*mm

These transparent 180mm height dividers can be easily separated by hand, so this way, they are 3 different lengths available (280, 380 and 480mm). They are ideal for creating an appropriate management on the shelves. They are often used to separate all types of products, like boxes, bottles, food, cans or other goods and also, thanks to its front stop in the form of "L", the products are perfectly ordered to the right side of the shelf while the left side allows an easy removal of the product.

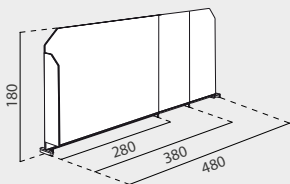

RIGHT FRONT SIZE

50.562 280/380/480x180mm x20 

## SECTIONABLE SHELF DIVIDER WITH RIGHT FRONT



## DIVIDER DETAILS



## INFORMATION

\*mm

These transparent 180mm height dividers can be easily separated by hand, so this way, they are 3 different lengths available (280, 380 and 480mm). They are ideal for creating an appropriate management on the shelves. They are often used to separate all types of products, like boxes, bottles, food, cans or other goods and also, thanks to its front stop in the form of "L", the products are perfectly ordered to the left side of the shelf while the right side allows an easy removal of the product.

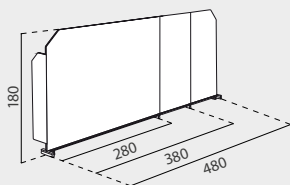

LEFT FRONT SIZE

50.563 280/380/480x180mm x20 

## SECTIONABLE SHELF DIVIDER WITH LEFT FRONT





## PUSHER DETAILS





## INFORMATION

\*mm

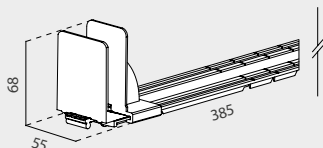
This transparent Divisible Pushing Lane is 385mm length and features 2 retainers. With a pusher-on-track design for use on any flat surface and display having an existing front fence. Variable steel spring force keeps a large variety of products faced. They are ideal for creating an appropriate organization on the shelves management.



PUSHING LANE	COLOR	SIZE	
50.851		55x385x68mm	x25 

## DIVISIBLE PUSHING LANE



## PUSHER DETAILS





## INFORMATION

\*mm

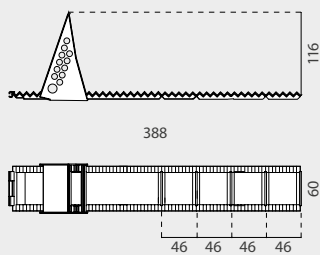
This Manual Shelf Pusher is composed by plastic parts made of transparent injected polycarbonate. With a pusher-on-track design for use on any flat surface and display having an existing front fence. Variable steel spring force keeps a large variety of products faced. They are ideal for creating an appropriate organization on the shelving management.



BREAKABLE	COLOR	SIZE	
50.500		60x388x115mm	x25 

## DIVISIBLE MANUAL PUSHER



## PUSHER DETAILS

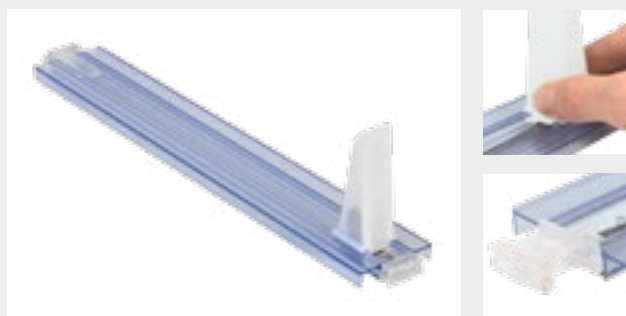

## INFORMATION

\*mm

This white Shelf Pusher is 20mm width and features a blue transparent acrylic 390mm length lane. With a pusher-on-track design for use on any flat surface and display having an existing front fence. It features 2 pushing force (normal and double). They are ideal for creating an appropriate organization on the shelves management.

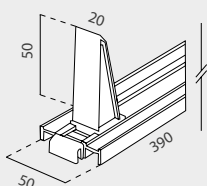

### PUSHER 20

### SIZE

50.520	50x390mm	Normal push force	x25 
50.522	50x390mm	Double push force	x25 

## SHELF PUSHER 20



## PUSHER DETAILS



## INFORMATION

\*mm

This white Shelf Pusher is 50mm width and features a blue transparent acrylic 390mm length lane. With a pusher-on-track design for use on any flat surface and display having an existing front fence. It features 2 pushing force (normal and double). They are ideal for creating an appropriate organization on the shelves management.

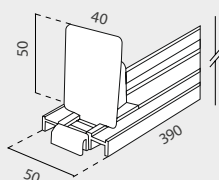

### PUSHER 40

### SIZE

50.521	50x390mm	Normal push force	x25 
50.523	50x390mm	Double push force	x25 

## SHELF PUSHER 40





## RETAINER DETAIL





### INFORMATION

### DIMENSIONS

\*mm

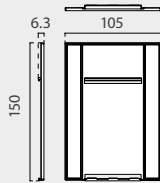
Plus Retainer is a shelving management accessory made of injected polycarbonate. It is suitable to combine with Manual Shelf Pusher (ref. 50.500) for increase support surfaces. With a push-on-track design for use on any flat surface and display having an existing front fence. They are ideal for creating an appropriate organization on the shelves management



RETAINER	COLOR	SIZE	
50.857		105x6.3x150mm	x25 

## PLUS RETAINER



## SUPPORT DETAILS



### INFORMATION

### DIMENSIONS

\*mm

This 25mm height Support for dividers is made of transparent injected polycarbonate. It is suitable for being used with acrylics up to 3mm thickness. With a wide 100mm base design for using on any flat surface, they are ideal for creating an appropriate organization on the shelving management at POS.

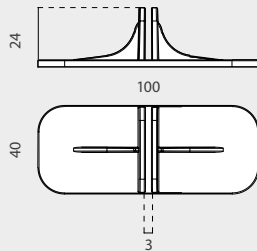

SUPPORT	COLOR	SIZE	MAX. THICK	
50.524		40x100x25mm	3mm	x25 

## DIVIDER SUPPORT



# STORE ACCESSORIES Plastic Shopping Baskets

## BASKET DETAILS



### INFORMATION

This Basket is made of break-resistant plastic with durable folding black plastic handles, also it is stackable to save valuable floor space. It features a front space for personalising with graphic. There are 5 colors available.

### DIMENSIONS

\*mm

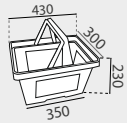

BASKET	COLOR	SIZE	
50.150		430x230x300mm	x5

## BASKET WITH TWO HANDLES



## BASKET DETAILS



### INFORMATION

This Basket is made of break-resistant plastic and features 4 wheels with 2 durable folding black plastic handles, one of the handles allows a comfortable movement of the basket. also it is stackable to save valuable floor space. 3 colors available.

### DIMENSIONS

\*mm

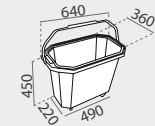

TROLLEY	COLOR	SIZE	
50.152		640x450x360mm	x5

## TROLLEY BASKET WITH FOUR WHEELS



## BASKET DETAILS



### INFORMATION

This Basket is made of break-resistant plastic and features 2 wheels with 2 durable folding black plastic handles, one of the handles allows a comfortable movement of the basket. also it is stackable to save valuable floor space. 3 colors available.

### DIMENSIONS

\*mm

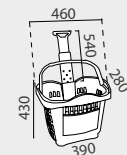

EXTENDABLE	COLOR	SIZE	
50.151		460x280x430mm	x5

## BASKET WITH EXTENDABLE HANDLE



## QUEUING SYSTEM DETAILS

## INFORMATION



This turn-o-matic system for queue management contains: screen + ticket dispenser + remote control + ticket roll + anchoring system + signage vinyl.



COMPLETE SCREEN TYPE

50.833 2 Digits x1

## COMPLETE QUEUING SYSTEM KIT



## QUEUING SYSTEM DETAILS

## INFORMATION



This Queuing System Kit contains: screen + remote control + anchoring system.



QUEUING SCREEN TYPE

50.832 2 Digits x1

## QUEUING SYSTEM



## DISPENSER DETAILS

## INFORMATION



Once your customer has taken a ticket, they are free to continue shopping. This makes their waiting time more productive for them and you and they will often buy more high margin last minute items.

DISPENSER SIZE

50.834 350x250x300mm x1   
 50.834BK 350x250x300mm x1

## TICKET DISPENSER



## ROLL DETAILS

## INFORMATION



It features 2000 tickets per roll and 3 digits per ticket. There are 5 colors available and they are ideal for the queuing management or for raffles.

TICKET ROLL COLOR TICKETS/ROLL

50.835 2000 x1

## TURN TICKET ROLL





## GUN DETAILS



## INFORMATION

These Label Guns features 1 or 2 dialing lines and 3 combinations of available digits.

LABEL GUN	TYPE		
50.843	1 line / 6 digits	x1	
50.844	2 lines / 8+6 digits	x1	
50.845	2 lines / 8+8 digits	x1	

## PRICE LABEL GUN



## INK ROLLER DETAILS



## INFORMATION

Ink roller replacement compatible with three price label gun models. Pack of 6 rollers.

DOUBLE LEG	SIZE		
50.852	190x93x180mm	x6	

## INK ROLLER REPLACEMENT



## NEEDLE DETAILS

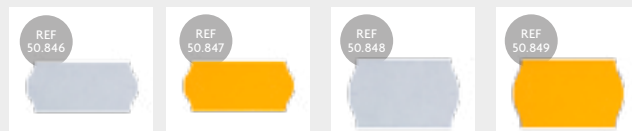

## INFORMATION

Label rolls for price label guns. Available in 2 sizes and two colors, white and orange.

TUBE	COLOR	SIZE	LABELS/ROLL		
50.846		26x12mm	1500	x5	
50.847		26x12mm	1500	x5	
50.848		26x16mm	1000	x5	
50.849		26x16mm	1000	x5	

## PRICE LABEL ROLL

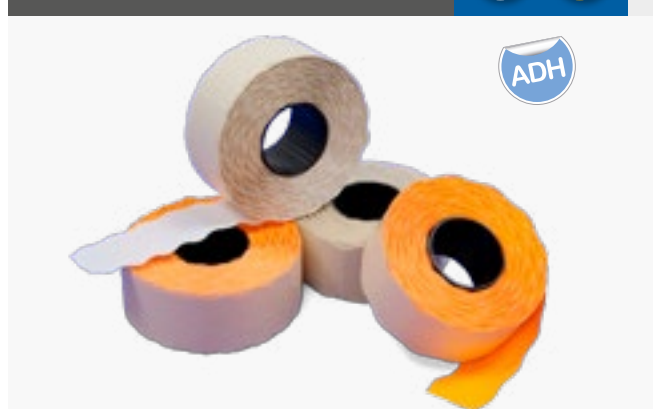

## TAGGING GUN DETAILS



### INFORMATION

Great for attaching tags and labels to clothes, toys, household items. All tagging guns come with wrist strap and protective needle cover.

TAGGING GUN	MODEL		
50.836	Standard	x1	
50.837	Fine	x1	

## TAGGING GUNS

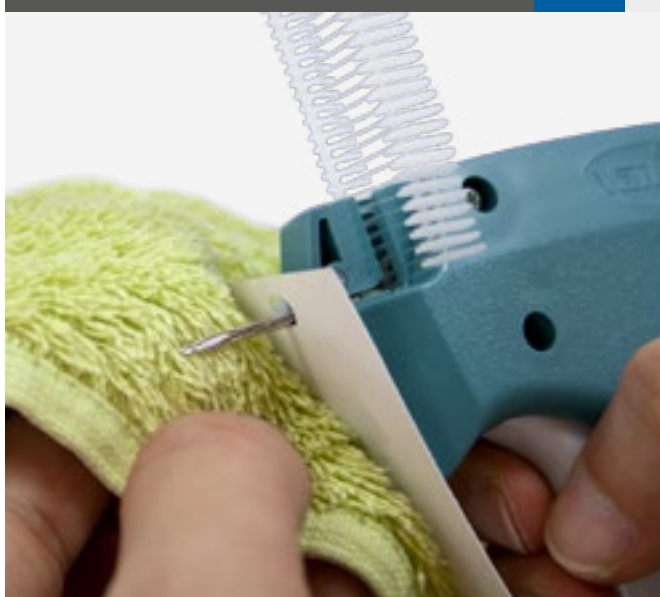

## NEEDLE DETAILS

\*mm



### INFORMATION

Plastic barbs for Standard and Fine tagging guns. Sold in pack of 5000 pieces.

BARBS	MODEL	LENGTH	
50.838	Standard	25mm	x5000
50.839	Fine	20mm	x5000

## TAGGING GUN BARBS

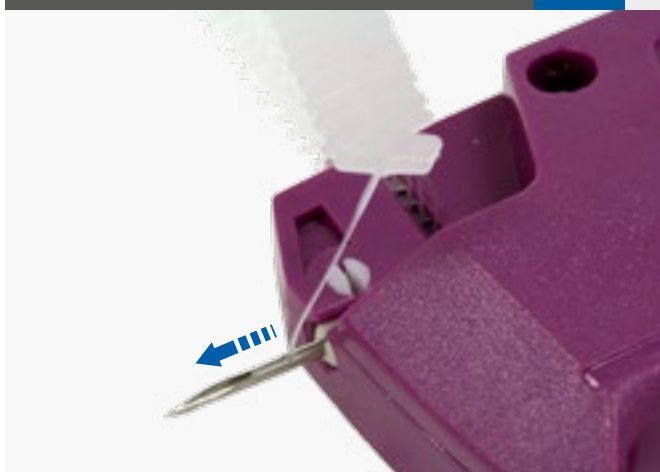

## NEEDLE DETAILS

INFORMATION \*mm



REF 50.841 REF 50.842

Needle replacements for Standard and Fine tagging guns. Sold in pack of 5 needles.

NEEDLES	MODEL	SIZE	
50.841	Standard	Ø1.8x18mm	x5
50.842	Fine	Ø1.3x13.7mm	x5

## NEEDLES FOR TAGGING GUN



# STORE ACCESSORIES Loop pins

## LOOP PIN DETAILS



## DIMENSIONS

\*mm

LENGTH

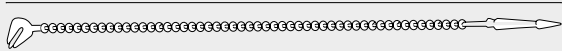

## INFORMATION

Flexible and easily adjustable plastic beaded loop pin. Ideal for attaching prices labels.

PLASTIC STRAP	LENGTH	
12.497	3" (76.20mm)	x1000
12.498	4" (101.60mm)	x1000
12.499	5" (127.00mm)	x1000
12.500	6" (152.40mm)	x1000
12.501	7" (177.80mm)	x1000

## PLASTIC BEADED LOOP PIN



## LOOP PIN DETAILS

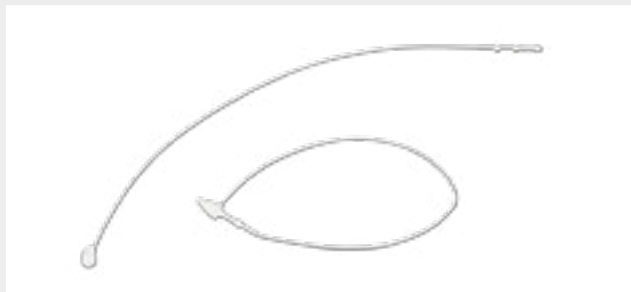

## DIMENSIONS

\*mm

LENGTH



## INFORMATION

Flexible and easily adjustable plastic loop pin. Ideal for attaching prices labels.

BEADED STRAP	SIZE	
12.492	3" (76.20mm)	x1000
12.493	4" (101.60mm)	x1000
12.494	5" (127.00mm)	x1000
12.495	6" (152.40mm)	x1000
12.496	7" (177.80mm)	x1000

## PLASTIC LOOP PIN



## DIVIDER DETAILS

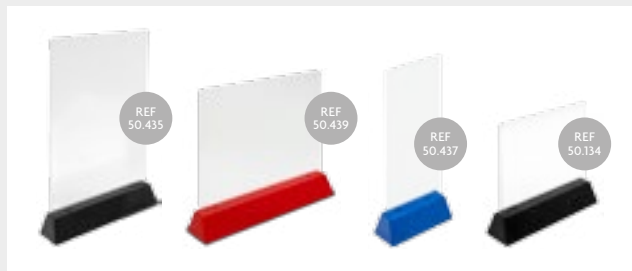

## DIMENSIONS

\*mm

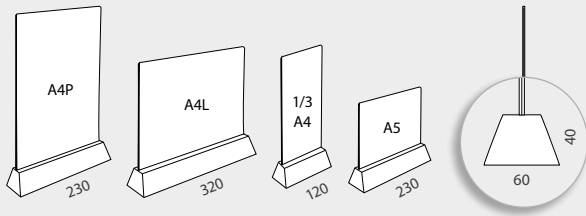

## INFORMATION

This Card Holder features a colored plastic base (3 colors available) with a transparent document holder available in 4 sizes. Ideal as marketing tool for a whole range of businesses such as restaurants, hotels, receptions, waiting rooms or supermarket as checkout divider. Graphic sheet not included.

A5 HOLDER	COLOR	SIZE	E
50.134		A5 210x148mm	x10
1/3 A4 HOLDER	COLOR	SIZE	E
50.437		1/3 A4 100x210mm	x10
A4 HOLDER	COLOR	SIZE	E
50.439		A4 landscape 297x210mm	x10
50.435		A4 portrait 210x297mm	x10

## BASE DIVIDER



## DIVIDER DETAILS

\*mm



## INFORMATION

This 350mm length Checkout Divider is made of anodised aluminium profile and finished with grey plastic endcaps. Ideal for being used with checkout counters.

DIVIDER	LENGTH	E
50.804	350mm	x1

## CHECKOUT DIVIDER



\* the graphic customization at this page are available but not included

## ID ADHESIVE SAFETY PIN CARD HOLDER

### HOLDER DETAILS



### INFORMATION

ID Holders with adhesive front and safety pin. On white or blue finish.

### DIMENSIONS

\*mm

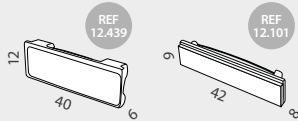

PIN HOLDER	COLOR	CARD INSERT SIZE		
12.439		40x12mm	x50	
12.101		42x9mm	x100	

## ID ADHESIVE SAFETY CLIP CARD HOLDER

### HOLDER DETAILS



### INFORMATION

ID Holders with clip for adhesive front and safety pin. On white or blue finish.

### DIMENSIONS

\*mm



ADHESIVE	COLOR	CARD INSERT SIZE		
12.100		12x29mm	x100	
12.443		12x25mm	x50	
12.102		19x19mm	x100	

## ID INSERT SAFETY PIN CARD HOLDER

### HOLDER DETAILS



### INFORMATION

ID Holders with adhesive front and safety pin. On white or grey finish.

### DIMENSIONS

\*mm

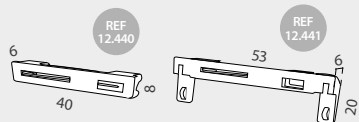

PIN HOLDER	COLOR	CARD INSERT SIZE		
12.440		40x7mm	x50	
12.441		52x20mm	x50	

## CLAMP CARD HOLDER

### HOLDER DETAILS



### INFORMATION

ID Card with metallic or plastic Clamp and transparent plastic holder. It is ideal for lanyards.

### DIMENSIONS

\*mm

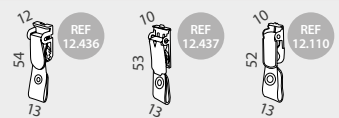

CLAMP	COLOR	SIZE		
12.436		14x53mm	x50	
12.437		15x52mm	x50	
12.110		13x51mm	x100	

\* plastic pockets at this page are available but not included

## CLIP CARD HOLDER

### HOLDER DETAILS

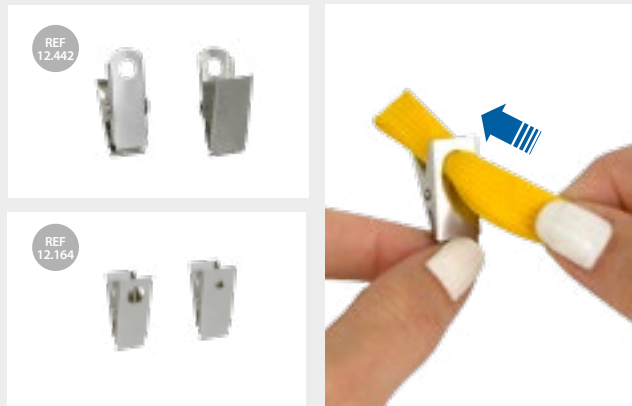

### INFORMATION

### DIMENSIONS

\*mm

ID Holders with clip for adhesive front and safety pin. On white or blue finish.



REF 12.442



REF 12.164

CLIP	COLOR	MATERIAL	SIZE		
12.442		Metal	12x30mm	x50 	
12.164		Metal	10x27mm	x100 	

## CURVED ID BADGE

### HOLDERS DETAILS







### INFORMATION

### DIMENSIONS

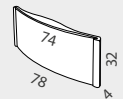
\*mm

Curved plastic ID badge with safety pin at the back. This badge is available in 2 colors.



CURVED	COLOR	GRAPHIC SIZE		
12.394		75x32mm	x10 	
12.395		75x32mm	x10 	

## CLAMP CARD HOLDER

### HOLDER DETAILS



### INFORMATION

### DIMENSIONS

\*mm

Clamp ID Holders suitable for the lanyards. They feature a plastic finish.







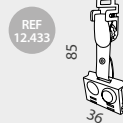

REF 12.435



REF 12.438



REF 12.433

CLAMP	COLOR	SIZE		
12.435		14x58x12mm	x50 	
12.438		14x30x16mm	x50 	
12.433		36x85x12mm	x50 	

## MAGNETIC CURVED ID BADGE

### HOLDERS DETAILS







### INFORMATION

### DIMENSIONS

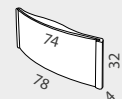
\*mm

Curved plastic ID badge with magnetic attachment. It is available in 2 colors (silver and black).



MAGNETIC C.	COLOR	GRAPHIC SIZE		
12.392		75x32mm	x10 	
12.393		75x32mm	x10 	

\* pockets, lanyards and badges at this page are available but not included

## ACRYLIC ID BADGE

### HOLDERS DETAILS







### INFORMATION

Acrylic badge with safety pin and clip. 2 sizes available.

### DIMENSIONS \*mm



ACRYLIC	COLOR	GRAPHIC SIZE	
12.390		50x40mm	x10 
12.391		60x25mm	x10 

## SAFETY PIN CARD HOLDER

### POCKET DETAILS

### DIMENSIONS \*mm



### INFORMATION

90x55mm transparent ID Card holder with safety pin and clip for attachment.

SAFETY PIN	GRAPHIC SIZE	
12.105	90x55mm	x50 

## PVC CARD POCKET 95x55

### POCKET DETAILS

### DIMENSIONS \*mm

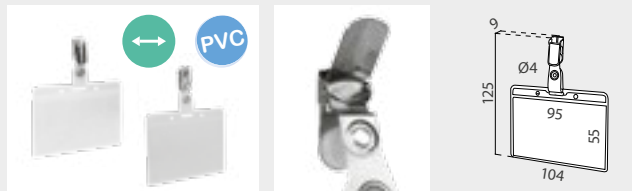

### INFORMATION

95x55mm landscape PVC pocket with clamp which prevents damage clothing

PVC 95x55	GRAPHIC SIZE	
12.107	95x55mm	x50 

## PVC CARD POCKET

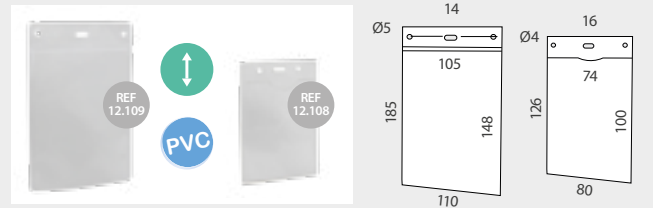

### POCKET DETAILS

### DIMENSIONS \*mm



### INFORMATION

PVC portrait ID pocket for cards on A6 format or 74x100mm (both available).

POCKET 74x100	GRAPHIC SIZE	
12.108	74x100mm	x50 
POCKET A6	CARD SIZE	
12.109	A6- 105x148mm	x50 

## FRAMED ID BADGE

### HOLDERS DETAILS







### INFORMATION

Black plastic ID badge with safety pin. 2 sizes available.

### DIMENSIONS \*mm



FRAMED	COLOR	GRAPHIC SIZE	
12.398		75x25mm	x10 
12.399		75x35mm	x10 

## MAGNETIC FRAMED ID BADGE

### HOLDERS DETAILS







### INFORMATION

Black plastic ID badge with magnetic attachment. Available in 2 sizes.

### DIMENSIONS \*mm



MAGNETIC	COLOR	GRAPHIC SIZE	
12.396		75x25mm	x10 
12.397		75x35mm	x10 

HOLDERS DETAILS



**INFORMATION** **DIMENSIONS** \*mm

Insert pocket for holding landscape or portrait ID Cards. Ideal for being used with the lanyards.

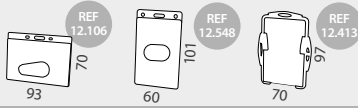

RIGID POCKET	CARD SIZE		
12.106	86x54mm	x10	
12.548	55x85mm	x10	
12.413	54x86mm	x10	

CARD RIGID POCKET



HOLDERS DETAILS



**INFORMATION** **DIMENSIONS** \*mm

Insert black pocket for holding landscape or portrait ID Cards. Ideal for being used with the lanyards.

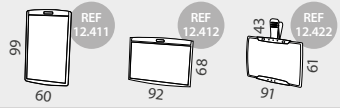

BLACK POCKET	CARD SIZE		
12.411	54x86mm	x10	
12.412	86x54mm	x10	
12.422	89x49mm	x10	

CARD BLACK POCKET





## LANYARD DETAILS



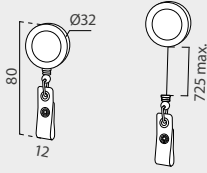

## DIMENSIONS

\*mm



## INFORMATION

Retractable reel for holding ID Cards. It is ideal as a card holder keychain

RETRACTABLE	COLOR	MAXIMUM LENGTH	
12.103		725mm	x50 
12.104		725mm	x50 

## RETRACTABLE CARD HOLDER



## LANYARD DETAILS

## DIMENSIONS

\*mm

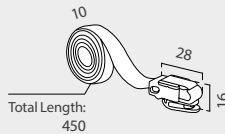

## INFORMATION

This 450mm length Lanyard has a plastic clip for holding ID Cards or visitor passes.

PLASTIC	SIZE	
12.432	450x11mm	x50 

## PLASTIC CLIP ID LANYARD



## LANYARD DETAILS

## DIMENSIONS

\*mm

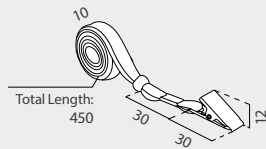

## INFORMATION

This 450mm length Lanyard has a metallic clip and a metallic attachment.

METALLIC	SIZE	
12.429	450x11mm	x50 

## METALLIC CLAMP ID LANYARD



## LANYARD DETAILS

## DIMENSIONS

\*mm

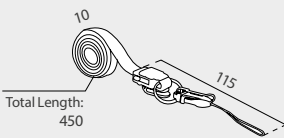

## INFORMATION

450mm length Lanyard with plastic clip, phone cord and metallic tension clip.

MULTI	SIZE	
12.431	450x11mm	x50 

## MULTIFUNCTION ID LANYARD



\* lanyards at this page are available but not included

DISPENSER DETAILS

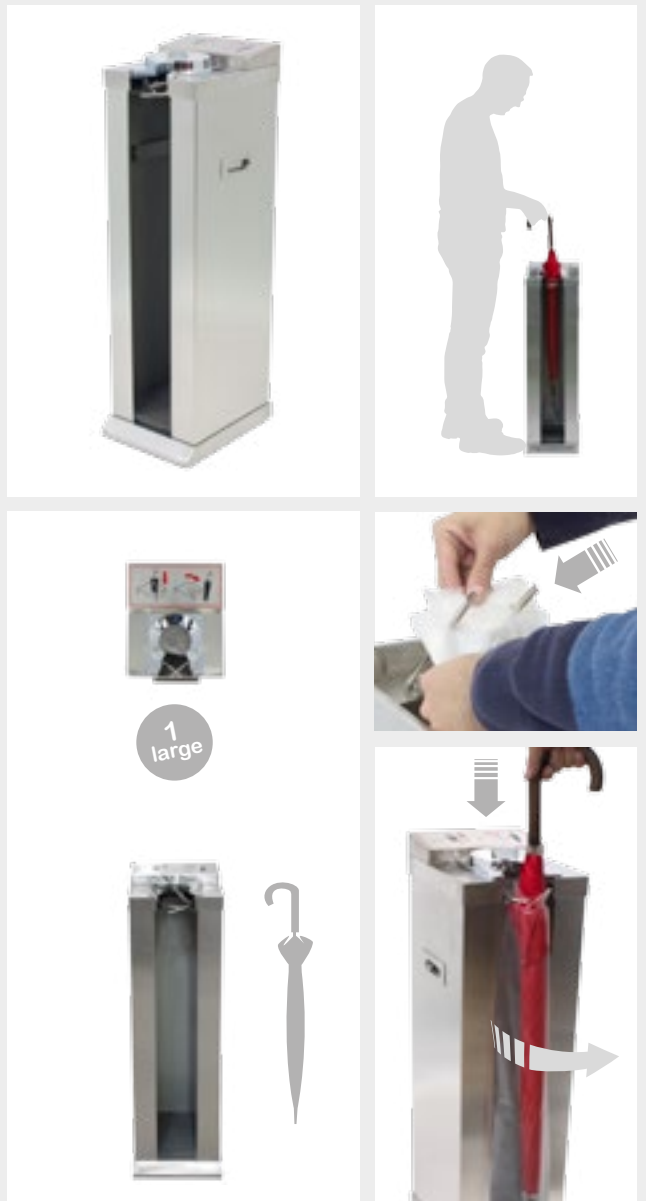

UMBRELLA BAG  
SINGLE DISPENSER



INFORMATION

DIMENSIONS

\*mm

Keep your facilities clean and safe avoiding accidents with this dispenser. Save on service and cleaning material. Protect easily your products and facilities from the water. Offering a space more comfortable for your employees and customers. Insert the umbrella through the upper hole and pull it horizontally outwards. Now you will have your umbrella on and you will be able to drive safely and comfortably by the establishment. It is ideal for being used at malls, supermarkets or at retail stores.

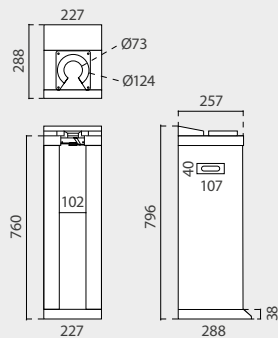

SINGLE	QTY	N.W	G.W	C.B.M	SIZE
Packing	1	5.85kg	7.40	0.053	280x345x854mm
81.500		227x288x796mm			

# STORE ACCESSORIES Umbrella Bag Double Dispenser

## DISPENSER DETAILS



## INFORMATION

## DIMENSIONS

\*mm

Keep your facilities clean and safe avoiding accidents with this dispenser. Save on service and cleaning material. Protect easily your products and facilities from the water. Offering a space more comfortable for your employees and customers. Insert the umbrella through the upper hole and pull it horizontally outwards. Now you will have your umbrella on and you will be able to drive safely and comfortably by the establishment. It is ideal for being used at malls, supermarkets or at retail stores.

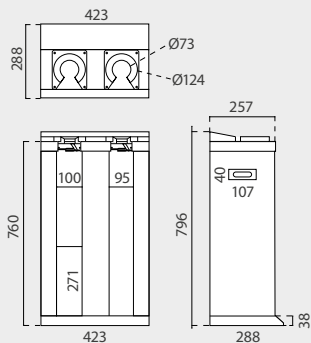

DOUBLE	QTY	N.W	G.W	C.B.M	SIZE
Packing	1	11.30kg	12.60kg	0.0793	340x470x845mm
81.501		423x288x796mm			

## UMBRELLA BAG DOUBLE DISPENSER



## BAGS DETAILS

## INFORMATION

\*mm

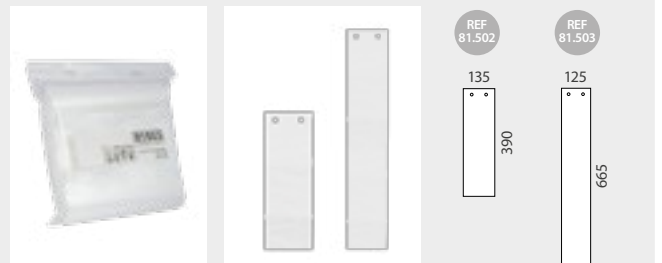

SMALL BAGS	QTY	N.W	G.W	C.B.M	SIZE
Packing	1	0.15kg	0.16kg	0.0005	170x140x20mm
81.502		x100 			
LARGE BAGS	QTY	N.W	G.W	C.B.M	SIZE
Packing	1	0.26kg	0.27kg	0.0007	240x140x20mm
81.503		x100 			

ASHTRAY DETAILS

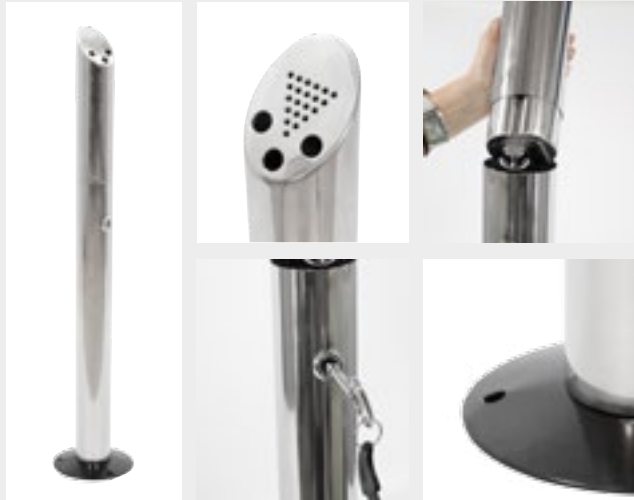

INFORMATION

DIMENSIONS \*mm

The Beresford outdoor ashtray pole is rust-resistant to keep the sleek, silver color throughout almost any weather conditions. Also, is lightweight enough to be transported to any location, but with the cast iron base and stainless steel frame it will remain sturdy. Its design makes it is ideal for shopping centers, airports and office buildings looking to keep their grounds free from unsightly butts.

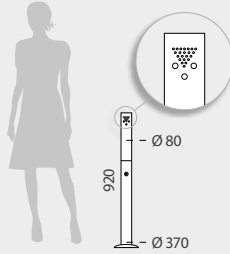

BERESFORD	QTY	N.W	G.W	C.B.M	SIZE
Packing	1	5.95kg	6.35kg	0.15	400x400x950mm
13.288		Ø370(base)xØ80x920mm			

BERESFORD

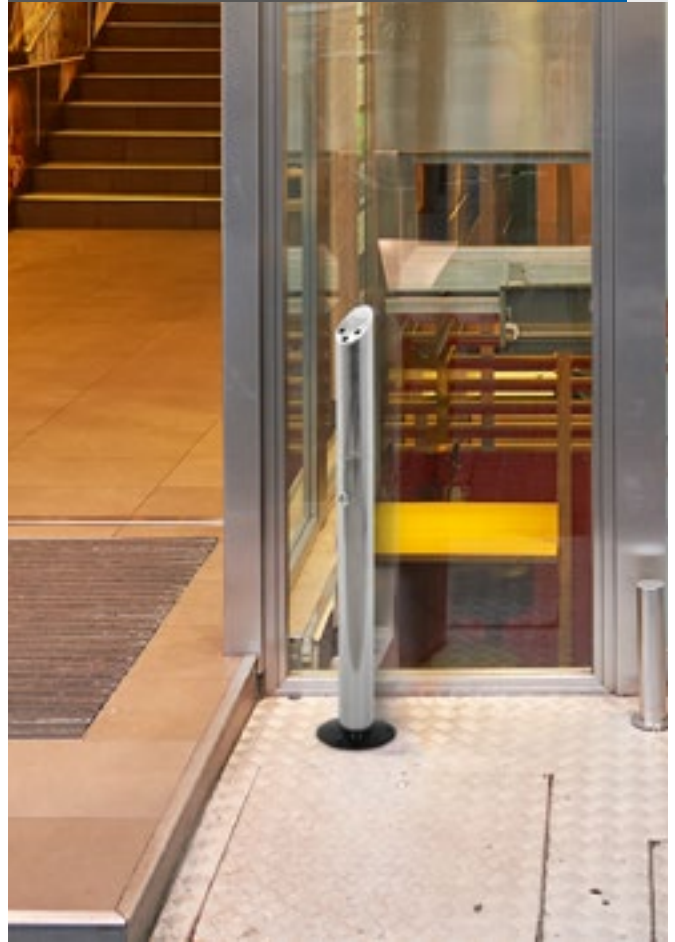

ASHTRAY DETAILS

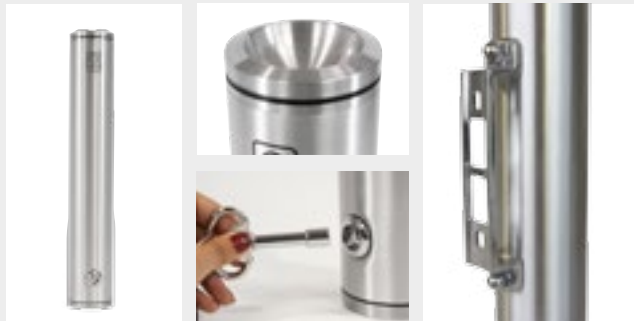

INFORMATION

DIMENSIONS \*mm

Sunbury ashtray is made of stainless steel and aluminium. With closing key system and accessories included. Its design makes it is ideal for shopping centers, airports looking to keep their grounds free from unsightly butts.

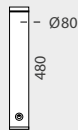

SUNBURY	QTY	N.W	G.W	C.B.M	SIZE
Packing	1	1.2kg	1.5kg	0.01	110x110x510mm
13.286		Ø80x480mm			

SUNBURY



ASHTRAY DETAILS



INFORMATION

The Popkum ashtray is made of stainless steel and aluminium. With closing key system and accessories included. It is ideal for mall centers, airports or offices.

\*mm

Ø80

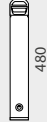

POPKUM	QTY	N.W	G.W	C.B.M	SIZE
Packing	1	1.1kg	1.4kg	0.01	110x110x510mm
13.284			Ø80x480mm		

POPKUM



ASHTRAY DETAILS



INFORMATION

Ashtray made of stainless steel and aluminium. With closing key system and accessories included. Ideal for being used at shopping centers, airports or at offices.

\*mm

80



PAULSON	QTY	N.W	G.W	C.B.M	SIZE
Packing	1	1.4kg	1.7kg	0.01	110x110x510mm
13.285			80x80x480mm		

PAULSON

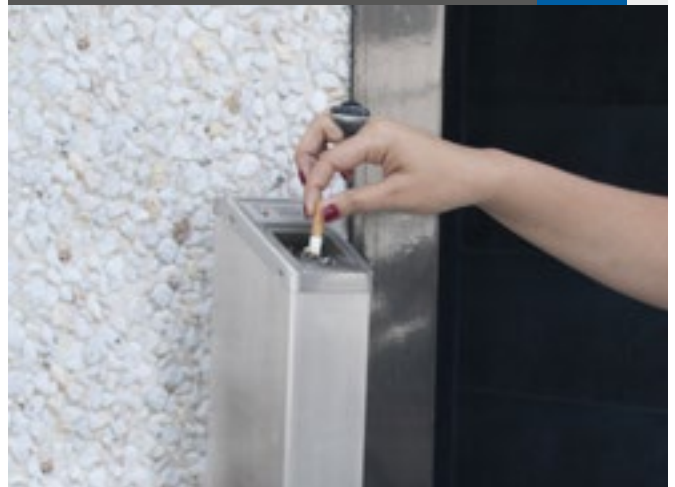

ASHTRAY DETAILS



INFORMATION

The Femdale ashtray is made of stainless steel and aluminium. With closing key system and accessories included. It is ideal for mall centers, airports or offices.

\*mm

80



FEMDALE	QTY	N.W	G.W	C.B.M	SIZE
Packing	1	1.45kg	1.75kg	0.01	110x110x510mm
13.287			80x80x480mm		

FEMDALE



## POSTS DETAILS

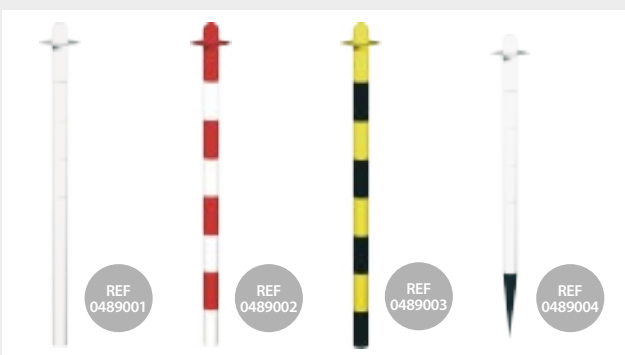





## INFORMATION

## DIMENSIONS

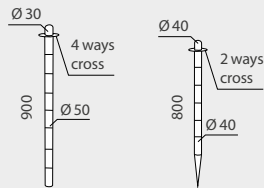
\* mm

These lightweight design poles come with 4-way and 2-way connecting ring. Various colors and finishes available. Ideal for areas like work lines and anywhere it is necessary to protect areas or to mark zones of prohibited or renewed access.



LIGHTWEIGHT	COLOR	POLE	TOP	HEIGHT
0489001		Ø 50mm	Ø 30mm	900mm
0489002		Ø 50mm	Ø 30mm	900mm
0489003		Ø 50mm	Ø 30mm	900mm
0489004		Ø 40mm	Ø 40mm	800mm

## LIGHTWEIGHT BARRIER POST



\* Base is available but not included.

## BASES DETAILS

made of rubber



REF  
0489005

made of plastic



4L

REF  
0489006

## DIMENSIONS

\* mm

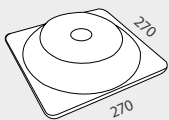

REF  
0489005

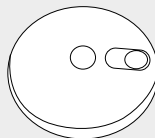

REF  
0489006

## INFORMATION

These bases are the best complement for light barrier posts, there are two different models, one made of plastic and refillable with 4l of water. The other one is manufactured in rubber and with dimensions of 270x270mm.

LIGHTWEIGHT	MATERIAL	SIZE
0489005	Rubber	Square - 270x270mm
0489006	Plastic	Round - Ø300mm

## BARRIER POLE BASES



\* Post is available but not included.

POST DETAILS



FLEXIBLE BOLLARD



INFORMATION

DIMENSIONS

\* mm

This flexible bollard is suitable for mounting on any surface. It is made of polyurethane and has a reflective band to improve its visibility. Thanks to its flexibility, this bollard always recovers its initial position once it has been hit.

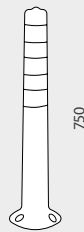

FLEXIBLE

HEIGHT

80.302

750mm

POST DETAILS



PORTABLE POST



INFORMATION

DIMENSIONS

\* mm

These portable post features a 6kg rubber base. It has a highly visible reflective band and it is suitable for tape or chain. Ideal for work lines and anywhere it is necessary to protect areas or to mark zones of prohibited or renewed access.

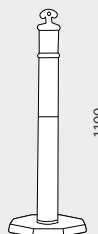

PORTABLE

HEIGHT

80.301

1100mm

## INFORMATION

## DIMENSIONS \*mm

This 300 height cone is made of polyethylene and it has a squared 220x220mm base and it features a 110mm reflective central band.

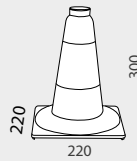

REFLECTIVE	COLOR	HEIGHT	BASE	WEIGHT	
47610032		300mm	220x220mm	0.25kg	x10

## REFLECTIVE CONE



*reflective*

## DIMENSIONS \*mm

REF 80.513

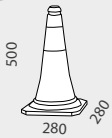

REF 80.512

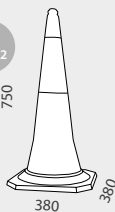

REF 80.511

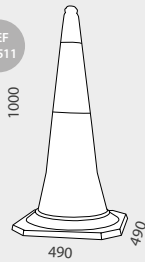

## INFORMATION

These cones are made of polyethylene and they feature an horizontal band made with highly visible reflective. There are 3 sizes available.

RUBBER BASE	COLOR	HEIGHT	BASE	BASE WEIGHT	
80.513		500mm	280x280mm	1.5kg	
80.512		750mm	380x380mm	2.5kg	
80.511		1000mm	490x490mm	5.0kg	

## REFLECTIVE CONES WITH RUBBER BASE



*reflective*

## DIMENSIONS \*mm

REF 80.501

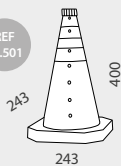

REF 80.502

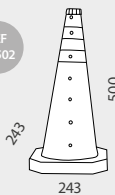

REF 80.503

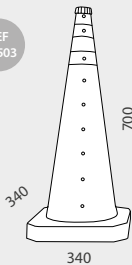

## INFORMATION

These Collapsible cones are made of nylon and feature a base of ABS. 2 reflective bands are included. There are 3 sizes available.

COLLAPSIBLE	COLOR	HEIGHT	BASE	BASE WEIGHT	
80.501		400mm	243x243mm	0.55kg	
80.502		500mm	243x243mm	0.55kg	
80.503		700mm	340x340mm	0.95kg	

## COLLAPSIBLE CONES WITH REFLECTIVE COLLARS



collapsible

*reflective*



CONE DETAILS



INFORMATION

DIMENSIONS

\*mm

These Caution Cones are made of sturdy polypropylene with yellow finish. There are 2 models available, with slippery floor prevention signage or without it.

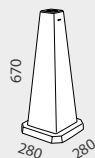

CONE	BASE	HEIGHT	WEIGHT		
80.603	280x280mm	670mm	1.1kg	x1	
80.604	280x280mm	670mm	1.1kg	x1	

CAUTION CONE



"A" BOARD DETAILS



INFORMATION

DIMENSIONS

\*mm

The Caution "A" Board is made of sturdy polypropylene with yellow finish. There are 2 models available, with slippery floor prevention signage or without it.

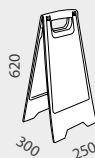

"A" BOARD	SIZE	WEIGHT		
80.601	250x300x620mm	0.6kg	x1	
80.602	250x300x620mm	0.6kg	x1	

CAUTION SIDEWALK



CHAINS DETAILS

DIMENSIONS \*mm

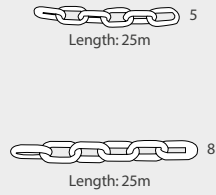

INFORMATION

These 25m chains are made of polyethylene. 2 widths and 3 colors available.

PLASTIC CHAIN	COLOR	WIDTH	LENGTH
0489011		5mm	25m
0489012		5mm	25m
0489008		8mm	25m
0489009		8mm	25m
0489010		8mm	25m

PLASTIC CHAIN



TAPES DETAILS

DIMENSIONS \*mm

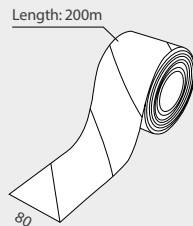

INFORMATION

These 200m length tapes are 80mm width. 2 colors available (black/yellow striped or red/white striped). Ideal to mark zones of prohibited or renewed access.

TAPES	COLOR	WIDTH	LENGTH
0479001		80mm	200m
0479004		80mm	200m

TAPE SIGNALLING



CONNECTORS DETAIL

INFORMATION

\*mm

These chain connectors are made of white plastic and there are 2 sizes available. They are ideal for being used with chains and cones or with poles.

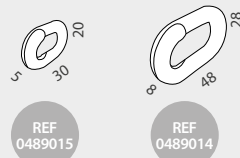



REF 0489015

REF 0489014

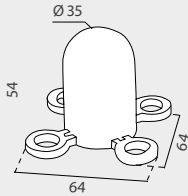

CONNECTORS	WIDTH
0489015	5mm
0489014	8mm

CHAIN CONNECTORS





TOPPER DETAIL		DIMENSIONS	*mm
			
INFORMATION			
<p>These Tops are suitable for being used with chains and posts or cones. 2 colors.</p>			
POST-CONE TOP	COLORS		
0489024		x10	

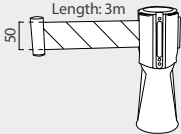

TOPPER DETAILS		DIMENSIONS	*mm
			
INFORMATION			
<p>This cone topper is suitable for cones above 3kg weight. It features a 3m length and retractable red/white striped belt. Ideal to mark zones of prohibited access.</p>			
TOPPER WITH BELT	BELT LENGTH		
80.516	3m		

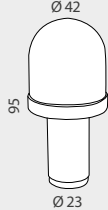

TOPPER DETAILS		DIMENSIONS	*mm
 			
INFORMATION			
<p>This cone topper is ideal to improve the visibility of cones. It has a diameter of Ø20mm. Ideal for signalling areas delimited by cones in low light conditions.</p>			
FLASHLIGHT	DIAMETER		
80.504	8mm		



\* Batteries are not included.

SIGN DETAILS

DIMENSIONS \*mm

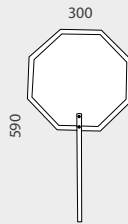
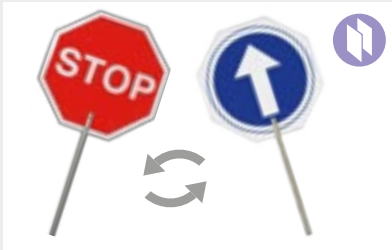

INFORMATION

One side has the "Stop" sign and the other one has the "one-way traffic" sign.

STOP/GO	SIZE	
0080011	590x300mm	x3 

STOP/GO SIGN PADDLE



BATON DETAIL

DIMENSIONS \*mm

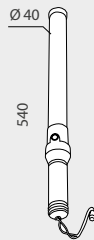

INFORMATION

This Red Traffic Baton features a LED illumination system and offers 3 operation modes: flashing light, steady light and off. It is ideal for traffic signaging.

RED BATON	LENGTH	DIAMETER
80.704	540mm	Ø40mm

RED TRAFFIC BATON



LAMPS DETAILS

DIMENSIONS \*mm

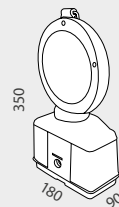

INFORMATION

LED flashing lamps are ideal to mark zones of prohibited access. 2 colors available.

FLASHING	COLOR	LED QUANTITY	
80.709		2 LEDs	x12 
80.710		2 LEDs	x12 

FLASHING LAMPS

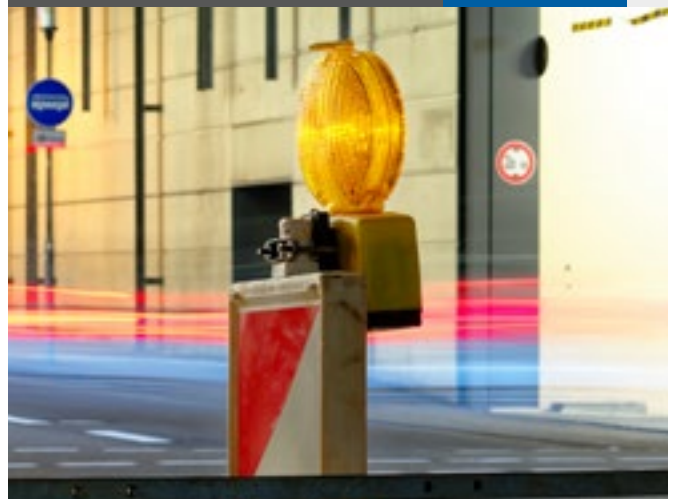

**INFORMATION**

**DIMENSIONS**

\*mm

This sign is made of yellow plastic and it features a Ø60mm red reflective circle and a hook for poles. it is ideal to mark zones and for traffic signing.

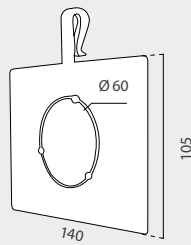

REFLECTIVE

SIZE

0489016

140x105mm

**REFLECTIVE SIGN WITH HOOK**

reflective



**SIGN DETAIL**

**DIMENSIONS**

\*mm

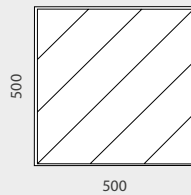

**INFORMATION**

This rear and reflective 500x500mm squared panel is ideal for protruding loads.

PROTRUDING

SIZE

00530001

500x500mm

**REAR REFLECTIVE PANEL FOR PROTRUDING LOADS**



**SUPPORTS DETAILS**

**DIMENSIONS**

\*mm

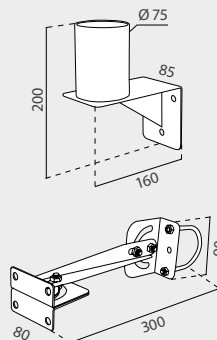

**INFORMATION**

\*mm

One model is suitable for wall mounting, and other one for wall or pole mounting.

SUPPORTS

MIRROR SIZE

80.104

for Ø800mm to Wall

80.124

for Ø450mm and Ø600mm to Wall or Pole

**MIRROR SUPPORTS**



\* Mirror not included.

MIRROR DETAILS

DIMENSIONS \*mm

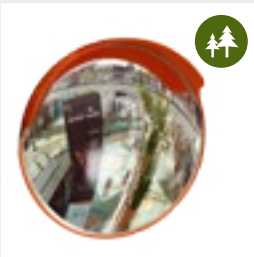

2 DIRECTIONS CONTROL

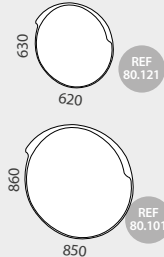

INFORMATION

Outdoor mirror with top cover and an adjustable viewing angle of 130°. For tubes with a min. diameter of Ø50mm or Ø70mm. Hardware and anchorage are included.

OUTDOOR	Ø MIRROR	Ø TUBE	SIZE
80.101	Ø800mm	Ø70mm	850x860x140mm
80.121	Ø600mm	Ø50mm	620x630x110mm

OUTDOOR MIRROR



MIRROR DETAILS

DIMENSIONS \*mm

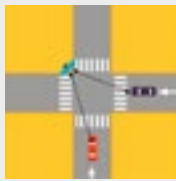

2 DIRECTIONS CONTROL

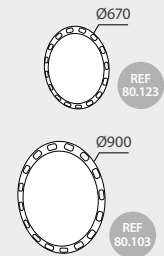

INFORMATION

Round mirror with polycarbonate lens and adjustable bending angle of 130°, featuring red and white reflective bands. Hardware and anchorage is included.

REFLECTIVE	MIRROR DIAMETER	SIZE
80.103	Ø800mm	900x900x120mm
80.123	Ø600mm	670x670x120mm

REFLECTIVE MIRROR



MIRROR DETAILS

DIMENSIONS \*mm

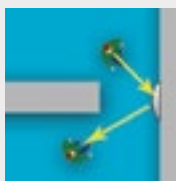

2 DIRECTIONS CONTROL

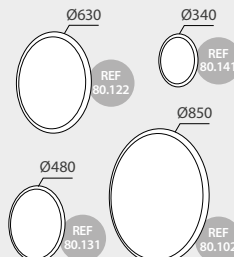

INFORMATION

Round Indoor mirror with polycarbonate lens and adjustable bending angle of 130°, featuring red and white reflective bands. Hardware and anchorage included.

INDOOR	MIRROR DIAMETER	SIZE
80.102	Ø800mm	850x850x130mm
80.122	Ø600mm	630x630x90mm
80.131	Ø450mm	480x480x80mm
80.141	Ø300mm	340x340x60mm

INDOOR MIRROR



MIRROR DETAILS

DIMENSIONS \*mm

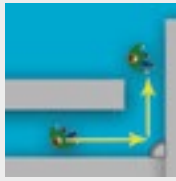
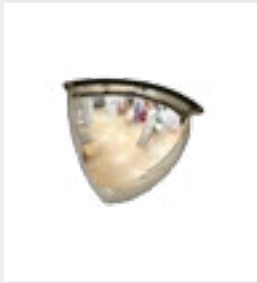

90° VIEW CONTROL  
CEILING

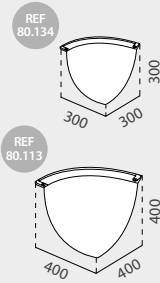

INFORMATION

Mirror with polycarbonate lens, 2 directions control and an adjustable bending angle of 90°. With a high impact resistance. Fixing screws included.

90°	MIRROR DIAMETER	SIZE
80.113	Ø650mm	400x400x400mm
80.134	Ø450mm	300x300x320mm

90° MIRROR



MIRROR DETAILS

DIMENSIONS \*mm

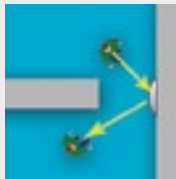

180° VIEW CONTROL  
CEILING

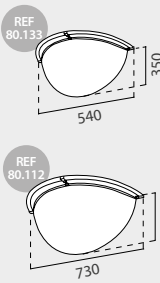

INFORMATION

This mirror with polycarbonate lens has an adjustable bending angle of 180°. Also, it features a high impact resistance. The fixing screws are included.

180°	MIRROR DIAMETER	SIZE
80.112	Ø650mm	730x420x380mm
80.133	Ø450mm	540x350x300mm

180° MIRROR

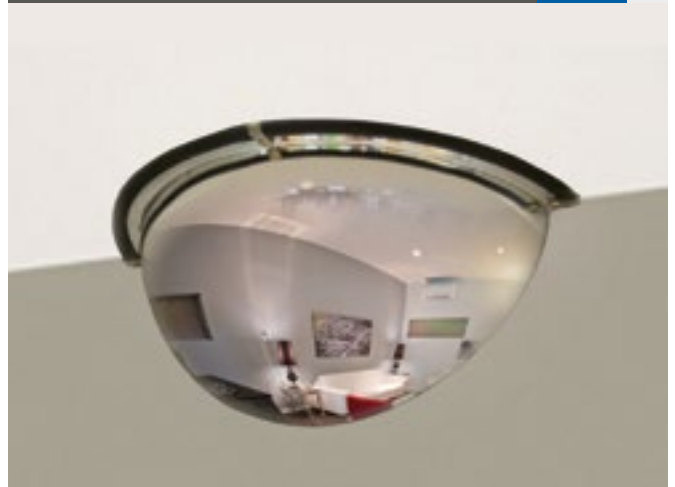

MIRROR DETAILS

DIMENSIONS \*mm



360° VIEW CONTROL  
CEILING

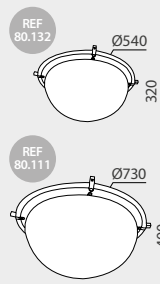

INFORMATION

This mirror has a lens made of polycarbonate with 4 direction control and 360° angle (adjustable). High impact resistance. Fixing screws included.

360°	MIRROR DIAMETER	SIZE
80.111	Ø650mm	730x730x400mm
80.132	Ø450mm	540x540x320mm

360° MIRROR



STOP DETAIL

DIMENSIONS \*mm

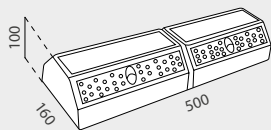

INFORMATION

This wheels rubber stopper allows the parking of the vehicle without exceeding the limit of the space. Easy assembly by fixing with screws (not included).

SMALL STOP SIZE

80.421 500x160x100mm

SMALL WHEEL STOP



STOP DETAIL



DIMENSIONS

\*mm

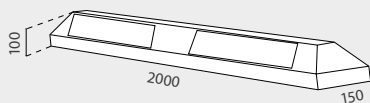

INFORMATION

This wheels rubber stopper allows the parking without exceeding the limit of the space. It can be used as a rail separator. Easy assembly by screws (not included).

LARGE STOP SIZE

80.427 2000x150x100mm

LARGE WHEEL STOP



GUARD DETAIL



DIMENSIONS

\*mm

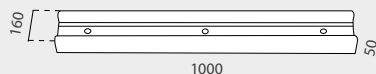

INFORMATION

This wall guard is designed to protect the vehicle and the wall. It is made of black rubber with yellow reflective central band. The guard protector is easy and quick to mount to wall by fixing with 3 screws.

WALL GUARD SIZE

80.426 1000x160x50mm

WALL GUARD

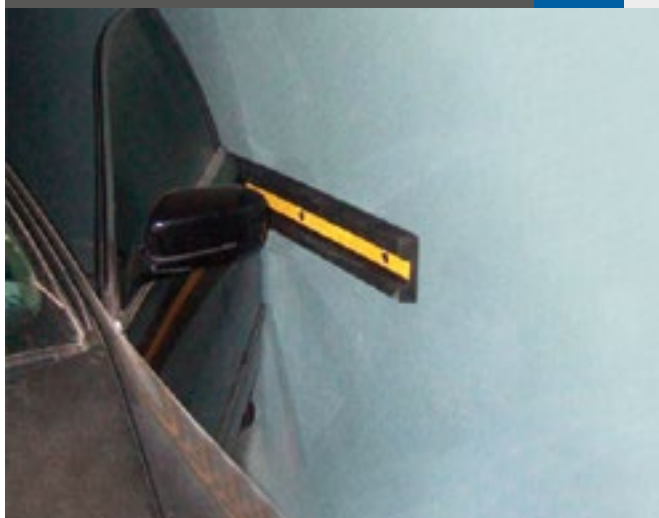



PROTECTORS DETAILS

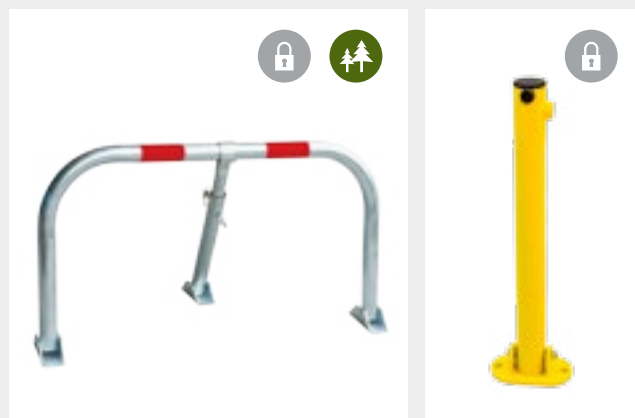

DIMENSIONS

\*mm

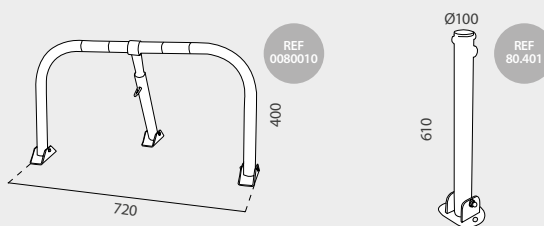

INFORMATION

These folding parking space protectors offer systems of great resistance. The first one (ref. 0080010) is a manual folding parking lock with padlock and features a robust system of great resistance thanks to its three points of anchorage. The second one (ref. 80.401) is a parking folding post made of steel, finish with yellow UV resistant paint for better visibility and durability. Easy to use and assembly. Also, they feature lock and keys (included). They are ideal for restricting access to the parking spaces.

RESTRICT	SIZE
0080010	720x400mm

PROTECTOR	SIZE	TUBE DIAMETER
80.401	175x610x100mm	Ø60mm

## RAWLPLUG AND SCREW

RAWLPLUG DETAIL

INFORMATION



This screw is made of metal and designed with expansion fit is ideal for solid materials such as walls or for concrete floors. Perfect for fixing wheel stoppers or parking accessories.

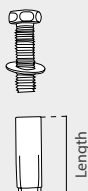

RAWLPLUG	LENGTH
80.611	50mm
80.613	70mm
80.614	90mm

## PARKING SPACE PROTECTORS



\*Screws are available but not included.

PROTECTORS DETAILS







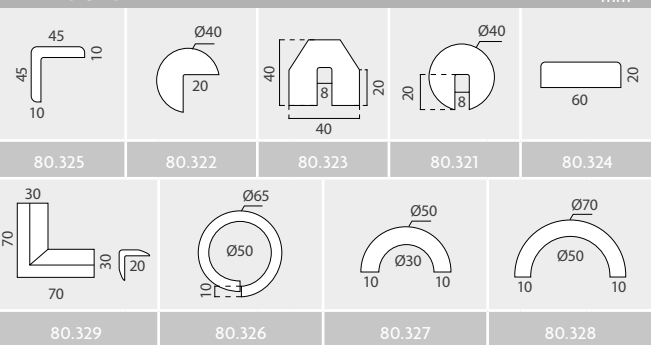





DIMENSIONS

\*mm



INFORMATION

These protectors are made of polyurethane so they can be easily cut to the desired length. It is resistant to UV rays and includes a back adhesive for a correct fixation.

STRAIGHT	SIZE	WEIGHT	
80.324	60x20x1020mm	0.35kg	x1 
PU CORNER	SIZE	WEIGHT	
80.329	70x30x10mm	0.02kg	x1 
CORNER PR.	SIZE	WEIGHT	
80.325	45x45x1040mm	0.35kg	x1 
80.322	Ø40mm	0.35kg	x1 
CORNER PR.	SIZE	WEIGHT	
80.323	40x40x1010mm	0.4kg	x1 
80.321	Ø40x1030mm	0.35kg	x1 
CIRCULAR	SIZE	WEIGHT	
80.326	Ø65x1000x10mm	0.5kg	x1 
SEMICIRCULAR	SIZE	WEIGHT	
80.327-RD	Ø30x50x1000mm	0.25kg	x1 
80.327-YE	Ø30x50x1000mm	0.25kg	x1 
80.328-RD	Ø50x70x1000mm	0.3kg	x1 
80.328-YE	Ø50x70x1000mm	0.3kg	x1 

POLYURETHANE PROTECTORS





## STRAIGHT CORNER GUARD



### INFORMATION

This straight corner is 800mm high and it is ideal for the protection of right angle corners that are prone to receive blows. It has 3 perforated on each side. Made of high strength rubber and yellow reflective vinyl for an improved visibility.



STRAIGHT	SIZE
80.411	800x100x10mm

## ROUNDED CORNER GUARD



### INFORMATION

This straight corner is 800mm high and it is ideal for the protection of right angle corners. Featuring rounded angle. It has 3 perforated on each side. Made of high strength rubber and yellow reflective vinyl for an improved visibility.



ROUNDED	SIZE
80.412	800x120x20mm

## RUBBER RAMP MODULAR

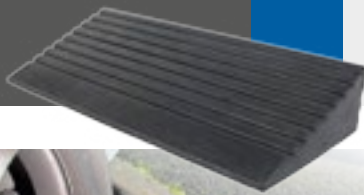

### INFORMATION

This Modular Ramp is 600mm wide and it is ideal for saving curbs and small slopes at parking entrances, garages, etc. The Modular Ramp is made of high strength black rubber and it is designed to support up to 5 tons of weight.



MODULAR	SIZE
80.424	600x250x100mm

## RUBBER RAMP ENDCAP



### INFORMATION

This Endcap Ramp has a dimension of 250x250mm and it is ideal for being used with Modular Ramp. Endcap is made of high strength black rubber and it is designed to support up to 5 tons of weight.



ENDCAP	SIZE
80.425	250x250x100mm

## RUBBER CABLE AND HOSE PROTECTOR

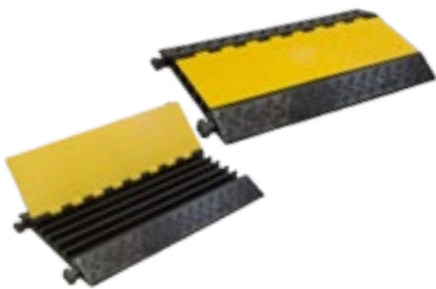

### INFORMATION

Rubber protector with plastic cover, features 5 channels for cable up to 42mm. It supports up to 10 tons. Ideal for events, fairs, works, etc.

ST.RUBBER	SIZE
80.422	900x500x55mm



### INFORMATION

Rubber 22.5° corner with plastic cover, features 5 channels for cable up to 42mm. It supports up to 10 tons. Ideal for events, fairs, works, etc.

CORNER	SIZE
80.423	310x500x55mm



### INFORMATION

Rubber protector with plastic cover, features 2 channels for cable up to 90mm. It supports up to 40 tons. Ideal for events, fairs, works, etc.

HOSE	SIZE
80.428	900x615x105mm



### CABLE PROTECTOR PLASTIC

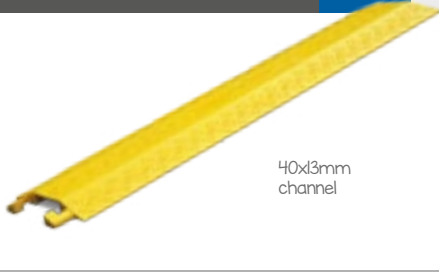

40x13mm  
channel

#### INFORMATION

Protector made of polyurethane with a cable channel of 40x13mm. Simple installation through "L" connections, without tools. Supports up to 1.5 tons. Ideal as an economic solution, ideal for shopping centers, construction areas, garages...

PROTECTOR	SIZE	CHANNEL SIZE
80.429	1000x140x20mm	40x13mm

### PORTABLE SPEED BUMP



carrying bag  
included



#### INFORMATION

Easy installation, can be folded in seconds to be able to transport it to another place. Made of polyurethane, supports up to 20 tons. Includes transport bag.

PORTABLE	SIZE
80.417	3000x250x25mm

durable rubber



### SPEED BUMP 35mm HEIGHT

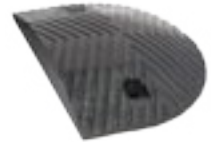

#### INFORMATION

Black rubber Reducer Stand-alone 500mm piece. Resistance to humidity and high temperatures.

35mm B	SIZE
80.413N	500x250x35mm

#### INFORMATION

Yellow rubber Reducer Stand-alone 500mm piece. Resistance to humidity and high temperatures.

35mm Y	SIZE
80.413A	500x250x35mm

#### INFORMATION

Black corner rubber Reducer Stand-alone piece. Resistance to humidity and high temperatures.

35 ENDCAP	SIZE
80.414	250x250x35mm



with cat's-eye  
reflectors



### SPEED BUMP 50mm HEIGHT

durable rubber



#### INFORMATION

This speed bump is made of rubber and includes 4 cat's eye reflectors for a better visibility. Great resistance to humidity and high temperatures.

50mm	SIZE
80.415	500x350x50mm

#### INFORMATION

Black corner rubber Reducer Stand-alone piece. Resistance to humidity and high temperatures. Ideal for being used with Speed Bump ref 80.415.

50 ENDCAP	SIZE
80.416	250x350x50mm

made of durable rubber

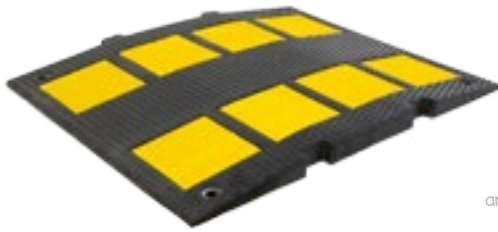

\* Fixing screws are not included

## SPEED HUMP

30mm HEIGHT



\* Fixing screws are not included

### INFORMATION

This 30mm high speed hump is made of durable rubber. Easy assembly by fixing with screws (not included). Great resistance to humidity and high temperatures.

30 HUMP	SIZE
80.418	500x600x30mm

### INFORMATION

This 30mm high speed hump End is made of durable rubber. Easy assembly by fixing with screws (not included). Great resistance to humidity and high temperatures.

30 ENDCAP	SIZE
80.419	225x600x30mm

made of durable rubber



\* Fixing screws are not included

## SPEED HUMP

50mm HEIGHT



\* Fixing screws are not included

### INFORMATION

This 50mm high speed hump is made of durable rubber. Easy assembly by fixing with screws (not included). Great resistance to humidity and high temperatures.

50 HUMP	SIZE
80.431	500x600x50mm

### INFORMATION

This 50mm high speed hump End is made of durable rubber. Easy assembly by fixing with screws (not included). Great resistance to humidity and high temperatures.

50 ENDCAP	SIZE
80.432	225x600x50mm



	EN	FR	PT	ES
	Carry bag included	Avec sac de transport	Inclui bolsa de transporte	Incluye bolsa de transporte
	One sided	Une face	Uma face	Una cara
	Double-Sided	Double face	Dupla face	Doble cara
	With motion	Avec mouvement	Com movimento	Con movimiento
	With light	Éclairé	Com luz	Con luz
	LED Technology	Technologie LED	Tecnologia LED	Tecnologia LED
	Telescopic	Télescopique	Telescópico	Telescópico
	Printed on textil	Impression sur toile	Impressão têxtil	Impresión sobre textil
	With lock	Avec serrure	Com fechadura	Con cerradura
	Rainproof	Imperméable	Impermeável	Impermeable
	Suitable for outdoor use	Pour l'extérieur	Para exterior	Para exterior
	With spotlights	Avec spot	Com focos	Focos incluidos
	With Adhesive	Avec adhésif	Con adesivo	Con adhesivo
	Cardboard	Carton	Cartão	Cartón
	With suction pad	Avec ventouse	Com ventosa	Con ventosa
	New Item	Nouvel article	Novidade	Producto nuevo
	Lightweight	Poids léger	Leve	Ligero
	Extraweight	Poids supplémentaire	Peso extra	Peso extra
	Flexible	Flexible	Flexível	Basculante
	Magnetic	Aimanté	Magnético	Magnético
	Plug-in	Électrique	Elétrico	A corriente
	Big Sizes	Grandes tailles	De grandes dimensões	Grandes dimensiones
	Portrait	Verticale	Vertical	Vertical
	Landscape	Horizontale	Horizontal	Horizontal
	Portrait / Landscape	Vertical ou horizontal	Vertical ou horizontal	Vertical u Horizontal
	"Click" System	Système "Click"	Sistema "Click"	Sistema "Click"
	With "Magic Tape"	Avec "Magic Tape"	Com "Magic Tape"	Con "Magic Tape"
	Acrylic	Acrylique	Acrílico	Acrílico
	Economic	Économique	Económico	Económico
	Tools required	Outils nécessaires	Montagem com ferramentas	Requiere herramientas
	No tools required	Aucun outil requis	Montagem sem ferramentas	No requiere herramientas
	Capacity	Capacité	Capacidade	Capacidad
	Request Price for large quantity	Demandez-nous remises quantitatives	Desconto por quantidades sob consulta	Descuento por cantidades bajo consulta
QTY	Quantity	Quantité	Quantidade	Cantidad
NW	Net weight	Poids net	Peso líquido	Peso neto
GW	Gross weight	Poids brut	Peso bruto	Peso bruto
CBM	Cubic meter	Mètres cubes	Metro cúbico	Cubicaje
Size	Measures	Mesures	Medidas	Medidas